

修 订	标 记	修 改 描 要	签 名	日 期
REV	MARK	REVISION DESCRIPTION	SIGNATURE	DATE
AO		NEW DWG		2016-03-12

NOTE:



一、 MATERIALS:

1. Housing: PBT BLACK.
2. Cover: PA66 BLACK.
3. Contacts: Brass
4. Shell: SPCC
5. Board Lock: SPCC
6. Rivet: Copper Alloy
7. Screw: SPCC

二、 FINISH:

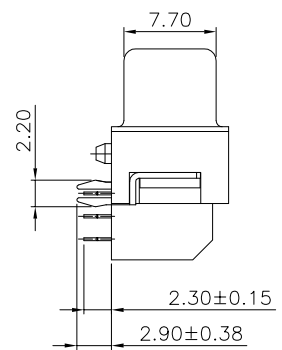
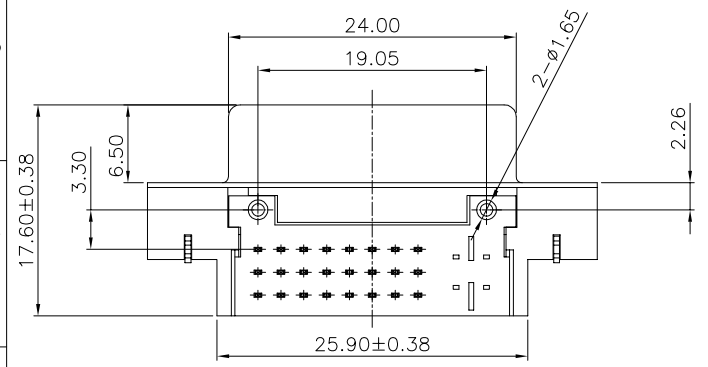
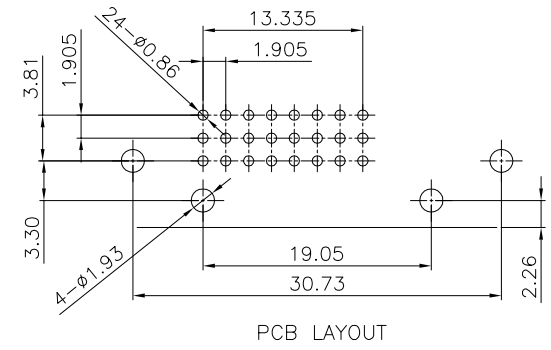
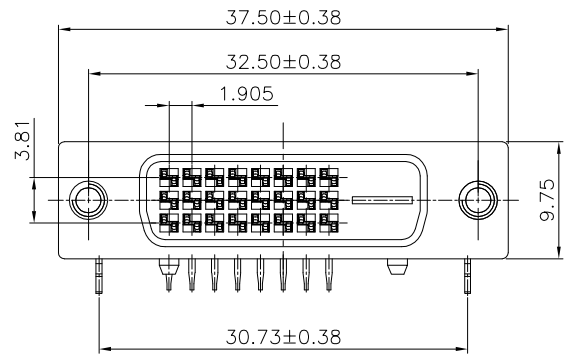
1. Contacts: Gold Plated on Contact Area
Sn Plated on Solderails
Nickel Under Plated Over All
2. Shell: Black Nickel Plated
3. Board Lock: Sn Plated
4. Rivet: Nickel Plated
5. Screw: Nickel Plated



		深圳市华德共创科技有限公司 Shenzhen Huade co-create Technology Co.,LTD 电话: 0755-23304126 传真: 0755-29940187						
-TOLERANCES- UNLESS OTHERWISE SPECIFIED 公差参数表				 		TITLE: 产品名称: DVI 24+1母座不带螺丝		
X.X	±0.30	X.X*	±3°	APPD: 核准:	PART NO: 产品编号: DVI-HX-105DIP			
X.XX	±0.20	X.XX*	±2°	CHECK: 校对: 王建业	DATE	SCALE	UNIT	CODE NUMBER
X.XXX	±0.10	X.XXX*	±1°	DRAW: 绘图: 黄艳兰	2016-03-12	1:1	mm	A001