



## Precision, High Speed, Hall-Effect Angle Sensor IC with Integrated Diagnostics for Safety-Critical Applications

### FEATURES AND BENEFITS

- Contactless 0° to 360° angle sensor IC, for angular position, rotational speed, and direction measurement
  - Capable of sensing magnet rotational speeds targeting 12b effective resolution with 900 G field
  - Circular Vertical Hall (CVH) technology provides a single channel sensor system supporting operation across a wide range of air gaps
- Developed in accordance with ISO 26262:2011 requirements for hardware product development for use in safety-critical applications
  - Single die version designed to meet ASIL B requirements when integrated and used in conjunction with the appropriate system-level control, in the manner prescribed in the A1333 Safety Manual
  - Dual die version designed to meet ASIL D requirements when integrated and used in conjunction with the appropriate system-level control, in the manner prescribed in the A1333 Safety Manual
- High diagnostic coverage
  - On-chip diagnostics include logic built-in self-test (LBIST), signal path diagnostics, and watchdogs to support safety-critical (ASIL) applications
  - 4-bit CRC on SPI
- On-chip EEPROM for storing factory and customer calibration parameters
  - Single-bit error correction, dual-bit error detection through the use of error correction control (ECC)

Continued on next page...

### DESCRIPTION

The A1333 is a 360° angle sensor IC that provides contactless high-resolution angular position information based on magnetic Circular Vertical Hall (CVH) technology. It has a system-on-chip (SoC) architecture that includes: a CVH front end, digital signal processing, and motor commutation (UVW) or encoder outputs (A, B, I). It also includes on-chip EEPROM technology, capable of supporting up to 100 read/write cycles, for flexible end-of-line programming of calibration parameters. The A1333 is ideal for automotive applications requiring 0° to 360° angle measurements, such as electronic power steering (EPS), rotary PRNDLs, and throttle systems.

The A1333 supports customer integration into safety-critical applications.

The A1333 is available in a dual-die 24-pin eTSSOP and a single-die 14-pin TSSOP package. The packages are lead (Pb) free with 100% matte-tin leadframe plating.

### PACKAGES:

24-pin eTSSOP (Suffix LP)

14-pin TSSOP (Suffix LE)

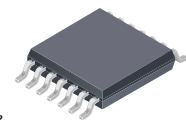
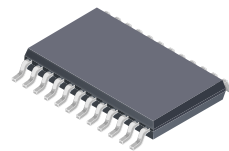

Not to scale

Dual Independent SoCs

Single SoC

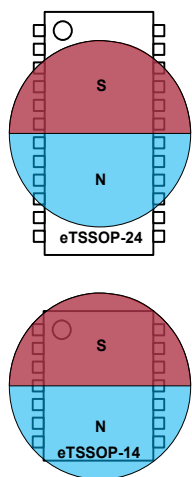

Magnet oriented for 0° output

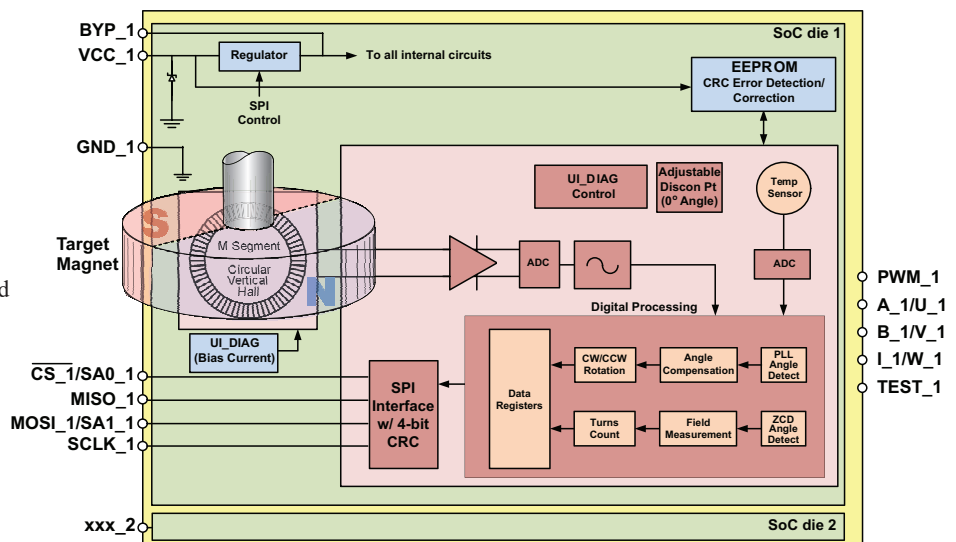

Figure 1: A1333 Magnetic Circuit and IC Diagram

### FEATURES AND BENEFITS (continued)

- Supports harsh operating conditions required for automotive and industrial applications, including direct connection to 12 V battery
  - Operating temperature range from  $-40^{\circ}\text{C}$  to  $150^{\circ}\text{C}$
  - Operating supply voltage range from 4.0 to 16.5 V
    - ◆ Can support ISO 7637-2 Pulse 5b up to 39 V
- Multiple output formats supported for ease of system integration
  - ABI/UVW output provides high resolution, low latency, and PWM for initial position
  - 10 MHz SPI for low latency angle and diagnostic information; enables multiple independent ICs to be connected to the same bus
  - Output resolution on ABI and UVW are selectable
- Multiple programming / configuration formats supported
  - The system can be completely controlled and programmed over SPI, including EEPROM writes
  - For system with limited pins available, writing and reading can be performed over VCC and PWM pins. This allows configuring the EEPROM in production line for a device with only ABI/UVW and PWM pins connected.
- Stacked dual die construction to improve die-to-die matching for systems that require redundant sensors
- Reduces magnet misalignment impact on die-to-die matching for a given magnet diameter, relative to “side-by-side” dual die orientation

### SELECTION GUIDE

Part Number	System Die	Package	Packing	Interface Voltage
A1333LLPTR-DD-T	Dual	24-pin eTSSOP	4000 pieces per 13-in. reel	3.3 V
A1333LLETR-T	Single	14-pin TSSOP	4000 pieces per 13-in. reel	3.3 V
A1333LLPTR-5-DD-T	Dual	24-pin eTSSOP	4000 pieces per 13-in. reel	5 V
A1333LLETR-5-T	Single	14-pin TSSOP	4000 pieces per 13-in. reel	5 V

### ABSOLUTE MAXIMUM RATINGS

Characteristic	Symbol	Notes	Rating	Unit
Forward Supply Voltage	$V_{CC}$	Not sampling angles	26.5	V
Reverse Supply Voltage	$V_{RCC}$	Not sampling angles	18	V
All Other Pins Forward Voltage	$V_{IN}$		5.5	V
All Other Pins Reverse Voltage	$V_R$		0.5	V
Operating Ambient Temperature <sup>[1]</sup>	$T_A$	L range	$-40$ to $150$	$^{\circ}\text{C}$
Maximum Junction Temperature	$T_J(\text{max})$		170	$^{\circ}\text{C}$
Storage Temperature	$T_{stg}$		$-65$ to $170$	$^{\circ}\text{C}$

<sup>[1]</sup> Maximum operational voltage is reduced at high ambient temperatures ( $T_A$ ). See Operating Characteristics, footnote 2.

### THERMAL CHARACTERISTICS: May require derating at maximum conditions; see application information

Characteristic	Symbol	Test Conditions <sup>[2]</sup>	Value	Unit
Package Thermal Resistance	$R_{\theta JA}$	LP-24 package	69	$^{\circ}\text{C}/\text{W}$
		LE-14 package	82	$^{\circ}\text{C}/\text{W}$

<sup>[2]</sup> Additional thermal information available on the Allegro website.

### Table of Contents

Features and Benefits.....	1	Device Programming Interfaces .....	29
Description .....	1	Interface Structure .....	29
Packages .....	1	SPI.....	30
Simplified Block Diagram .....	1	Manchester Interface.....	35
Selection Guide .....	2	EEPROM and Shadow Memory Usage.....	41
Absolute Maximum Ratings .....	2	Enabling EEPROM Access.....	41
Thermal Characteristics .....	2	EEPROM Write Lock.....	41
Pinout Diagrams and Terminal Lists.....	4	Write Transaction to EEPROM and Other Extended Locations.....	41
Operating Characteristics .....	6	Read Transaction to EEPROM and Other Extended Locations.....	45
Typical Performance Characteristics.....	9	Shadow Memory Read and Write Transactions.....	47
Functional Description .....	14	Primary Serial Interface Registers Reference .....	48
Overview .....	14	EEPROM/Shadow Memory Table.....	62
Angle Measurement .....	14	Safety and Diagnostics .....	71
System Level Timing .....	14	Built-In Self Tests .....	71
Impact of High Speed Sensing.....	14	Status and Error Flags.....	71
Measured Performance Over RPM .....	15	Application Information .....	75
Power-Up.....	18	ESD Performance .....	75
PWM Output .....	18	Setting the Zero-Degree Position .....	76
Incremental Output Interface (ABI).....	19	Magnetic Target Requirements .....	76
Brushless DC Motor Output (UVW).....	25	Magnetic Misalignment .....	77
Angle Hysteresis.....	27	I/O Structures .....	78
Turns Counting .....	28	Package Outline Drawings .....	79
		APPENDIX A: Angle Error and Drift Definition.....	A-1
		APPENDIX B: SPI Interface Error Flag Description .....	B-1

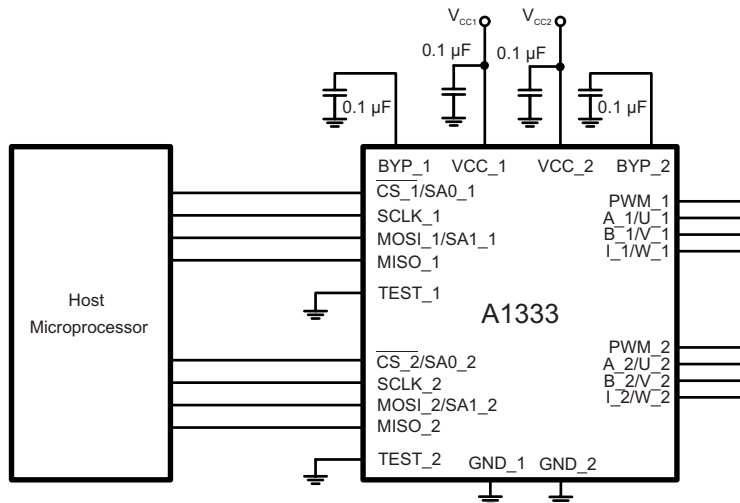
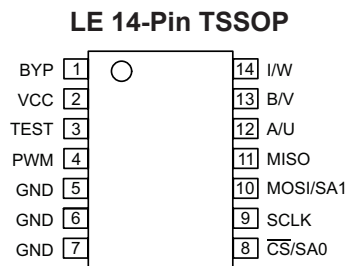

**Figure 2: Typical Application Circuit**

Both die are electrically separate, and may be operated simultaneously using different Power/GND sources.

### PINOUT DIAGRAMS AND TERMINAL LIST TABLES

#### Pinout Diagram



#### LE 14-Pin TSSOP Terminal List Table

Pin Name	Pin Number	Function
BYP	1	External bypass capacitor terminal for internal regulator
VCC	2	Power Supply / Manchester Input
TEST	3	Test pin; bring to GND
PWM	4	PWM Angle Output / Manchester Output
GND	5, 6, 7	Device ground terminal
$\overline{\text{CS}}/\text{SA0}$	8	SPI: Chip Select terminal, active low input Manchester: LSB of ID value. Tie to BYP for "1", GND for "0"
SCLK	9	SPI Clock terminal input
MOSI/SA1	10	SPI: Master Output, Slave Input Manchester: MSB of ID value. Tie to BYP for "1", GND for "0"
MISO	11	SPI Master Input / Slave Output
A/U	12	Option 1: Quadrature A output signal Option 2: U (phase 1) output signal
B/V	13	Option 1: Quadrature B output signal Option 2: V (phase 2) output signal
I/W	14	Option 1: Quadrature I (index) output signal Option 2: W (phase 3) output signal

### Pinout Diagram

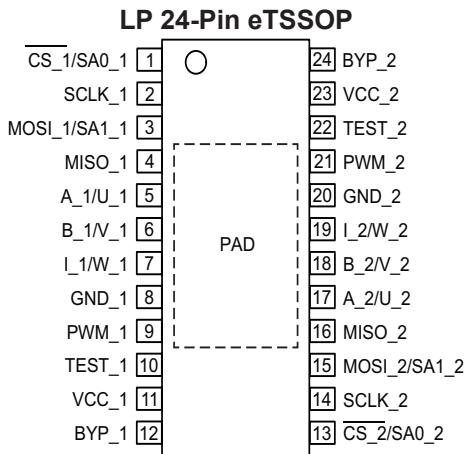

### LP 24-Pin eTSSOP Terminal List Table

Pin Name	Pin Number	Function
$\overline{\text{CS}}_1/\text{SA0}_1$	1	SPI: Chip Select terminal, active low input (die 1) Manchester: LSB of ID value for die 1. Tie to BYP_1 for "1", GND_1 for "0"
SCLK_1	2	SPI Clock terminal input (die 1)
MOSI_1/SA1_1	3	SPI: Master Output, Slave Input (die 1) Manchester: MSB of ID value for die 1. Tie to BYP_1 for "1", GND_1 for "0"
MISO_1	4	SPI Master Input / Slave Output (die 1)
A_1/U_1	5	Option 1: Quadrature A output signal signal (die 1) Option 2: U (phase 1) output signal (die 1)
B_1/V_1	6	Option 1: Quadrature B output signal (die 1) Option 2: V (phase 2) output signal (die 1)
I_1/W_1	7	Option 1: Quadrature I (index) output signal (die 1) Option 2: W (phase 3) output signal (die 1)
GND_1	8	Device ground terminal (die 1)
PWM_1	9	PWM Angle Output / Manchester Output (die 1)
TEST_1	10	Test pin; bring to GND (die 1)
VCC_1	11	Power Supply / Manchester Input (die 1)
BYP_1	12	External bypass capacitor terminal for internal regulator (die 1)
$\overline{\text{CS}}_2/\text{SA0}_2$	13	SPI: Chip Select terminal, active low input (die 2) Manchester: LSB of ID value for die 2. Tie to BYP_2 for "1", GND_2 for "0"
SCLK_2	14	SPI Clock terminal input (die 2)
MOSI_2/SA1_2	15	SPI: Master Output, Slave Input (die 2) Manchester: MSB of ID value for die 2. Tie to BYP_2 for "1", GND_2 for "0"
MISO_2	16	SPI Master Input / Slave Output (die 2)
A_2/U_2	17	Option 1: Quadrature A output signal (die 2) Option 2: U (phase 1) output signal (die 2)
B_2/V_2	18	Option 1: Quadrature B output signal (die 2) Option 2: V (phase 2) output signal (die 2)
I_2/W_2	19	Option 1: Quadrature I (index) output signal (die 2) Option 2: W (phase 3) output signal (die 2)
GND_2	20	Device ground terminal (die 2)
PWM_2	21	PWM Angle Output / Manchester Output (die 2)
TEST_2	22	Test pin; bring to GND (die 2)
VCC_2	23	Power Supply / Manchester Input (die 2)
BYP_2	24	External bypass capacitor terminal for internal regulator (die 2)
PAD	PAD	Exposed pad for thermal dissipation

**OPERATING CHARACTERISTICS:** Valid over the full operating voltage and ambient temperature ranges, unless otherwise noted

Characteristics	Symbol	Test Conditions	Min.	Typ.	Max.	Unit [1]
<b>ELECTRICAL CHARACTERISTICS</b>						
Supply Voltage [2]	$V_{CC}$	Customer supply	4.0	–	16.5	V
Supply Current	$I_{CC}$	One die, sampling angles	–	17	19	mA
Undervoltage Flag Threshold [3]	$V_{UVD}$	$dV/dt = 1 \text{ V/ms}$ , A1333 sampling enabled, $T_A = 25^\circ\text{C}$	3.6	–	3.9	V
Supply Zener Clamp Voltage	$V_{ZSUP}$	$I_{CC} = I_{CC} + 3 \text{ mA}$ , $T_A = 25^\circ\text{C}$	26.5	–	–	V
Reverse Battery Current	$I_{RCC}$	$V_{RCC} = 18 \text{ V}$ , $T_A = 25^\circ\text{C}$	–	–	5	mA
Power-On Time [4]	$t_{PO}$	Power-on diagnostics disabled	–	15	–	ms
	$t_{PO\_D}$	Power-on time; CVH self-test and LBIST enabled	–	45	–	ms
Bypass Pin Output Voltage [5]	$V_{BYP}$	$T_A = 25^\circ\text{C}$ , $C_{BYP} = 0.1 \mu\text{F}$ , 3.3 V interface	2.97	3.3	3.63	V
		$T_A = 25^\circ\text{C}$ , $C_{BYP} = 0.1 \mu\text{F}$ , 5.0 V interface enabled and $V_{CC} \geq 5.0 \text{ V}$	4.0	5.0	5.5	V
<b>SPI AND ABI (UVW) ELECTRICAL SPECIFICATIONS (3.3 V INTERFACE)</b>						
Digital Input High Voltage	$V_{IH}$	MOSI, SCLK, $\overline{\text{CS}}$ pins	2.8	–	3.63	V
Digital Input Low Voltage	$V_{IL}$	MOSI, SCLK, $\overline{\text{CS}}$ pins	–	–	0.5	V
Output High Voltage	$V_{OH}$	MISO, ABI/UVW pins, $C_L = 20 \text{ pF}$	2.93	3.3	3.63	V
Output Low Voltage	$V_{OL}$	MISO, ABI/UVW pins, $C_L = 20 \text{ pF}$	–	0.3	–	V
<b>SPI AND ABI (UVW) ELECTRICAL SPECIFICATIONS (5.0 V INTERFACE)</b>						
Digital Input High Voltage	$V_{IH}$	MOSI, SCLK, $\overline{\text{CS}}$ pins	3.75	–	5.5	V
Digital Input Low Voltage	$V_{IL}$	MOSI, SCLK, $\overline{\text{CS}}$ pins	–	–	0.5	V
Output High Voltage	$V_{OH}$	MISO, ABI/UVW pins, $C_L = 20 \text{ pF}$ , $V_{CC} \geq 5.0 \text{ V}$	4	5	5.5	V
Output Low Voltage	$V_{OL}$	MISO, ABI/UVW pins, $C_L = 20 \text{ pF}$	–	0.3	–	V
<b>SPI INTERFACE SPECIFICATIONS</b>						
SPI Clock Frequency [6]	$f_{SCLK}$	MISO pins, $C_L = 20 \text{ pF}$	0.1	–	10	MHz
SPI Clock Duty Cycle [6]	$D_{fSCLK}$	$SPI_{CLKDC}$	40	–	60	%
SPI Frame Rate [6]	$t_{SPI}$	16-bit SPI packet	5.8	–	588	kHz
Chip Select to First SCLK Edge [6]	$t_{CS}$	Time from $\overline{\text{CS}}$ going low to SCLK falling edge	50	–	–	ns
Chip Select Idle Time [6]	$t_{CS\_IDLE}$	Time $\overline{\text{CS}}$ must be high between SPI message frames	200	–	–	ns
Data Output Valid Time [6]	$t_{DAV}$	Data output valid after SCLK falling edge	–	30	–	ns
MOSI Setup Time [6]	$t_{SU}$	Input setup time before SCLK rising edge	25	–	–	ns
MOSI Hold Time [6]	$t_{HD}$	Input hold time after SCLK rising edge	50	–	–	ns
SCLK to CS Hold Time [6]	$t_{CHD}$	Hold SCLK high time before $\overline{\text{CS}}$ rising edge	5	–	–	ns
Load Capacitance [6]	$C_L$	Loading on digital output (MISO) pin	–	–	20	pF

Continued on the next page...

**OPERATING CHARACTERISTICS (continued):** Valid over the full operating voltage and ambient temperature ranges, unless otherwise noted

Characteristics	Symbol	Test Conditions	Min.	Typ.	Max.	Unit [1]
<b>PWM INTERFACE SPECIFICATIONS</b>						
PWM Carrier Frequency	$f_{\text{PWM}}$	PWM Frequency Min Setting	–	98	–	Hz
		PWM Programmable Options (7 bits)	–	128	–	options
		PWM Frequency Max Setting	–	3.125	–	kHz
PWM Output Low Clamp	$D_{\text{PWM}(\text{min})}$	Corresponding to digital angle of 0x000	–	5	–	%
PWM Output High Clamp	$D_{\text{PWM}(\text{max})}$	Corresponding to digital angle of 0xFF	–	95	–	%
<b>INCREMENTAL OUTPUT, ABI (UVW) SPECIFICATIONS</b>						
ABI and UVW Output Angular Hysteresis [6]	$\text{hys}_{\text{ANG}}$	Programmable via EEPROM (6 bits)	0	–	1.38	degrees
AB Channel Resolution [6]	$\text{RES}_{\text{AB}}$	Programmable via EEPROM, 4 bit field. Specified in pulses per revolution, PPR	1	–	2048	PPR
AB Quadrature Resolution [6]	$\text{RES}_{\text{AB\_INT}}$	Equal to $4 \times \text{RES}_{\text{AB}}$ , specified in counts per revolution, CPR	4	–	8192	CPR
UVW Pole Pairs [6]	$N_{\text{pole}}$	DC commutation signals. Programmable via EEPROM, 4-bit field.	1	–	16	pole pairs
Maximum Sourcing Current	$I_{\text{SOURCE}}$	Output voltage $\geq 2.5$ V	–	1.5	–	mA
Maximum Sinking Current	$I_{\text{SINK}}$	5 V IO setting; output voltage $\approx 0.35$ V	–	4.5	–	mA
<b>MANCHESTER INTERFACE SPECIFICATIONS</b>						
Manchester High Voltage	$V_{\text{MAN}(\text{H})}$	Applied to VCC line	7.3	8	$V_{\text{CC}(\text{max})}$	V
Manchester Low Voltage	$V_{\text{MAN}(\text{L})}$	Applied to VCC line	$V_{\text{CC}(\text{min})}$	5	5.7	V
Manchester Bit Rate	$f_{\text{MAN}}$	Line state changes once or twice per bit; maximum speed is usually limited by VCC line capacitance	2.2	–	100	kbit/s
<b>BUILT-IN SELF TEST</b>						
Logic BIST Time	$t_{\text{LBIST}}$	Configurable to run on power-up or on user request. Runs in parallel with CVH self-test (if enabled).	–	30	–	ms
Circular Vertical Hall Self-Test Time	$t_{\text{CVHST}}$	Configurable to run on power-up or on user request. Runs in parallel with LBIST (if enabled).	–	30	–	ms

Continued on the next page...

**OPERATING CHARACTERISTICS (continued):** Valid over the full operating voltage and ambient temperature ranges, unless otherwise noted

Characteristics	Symbol	Test Conditions	Min.	Typ.	Max.	Unit <sup>[1]</sup>
<b>MAGNETIC CHARACTERISTICS</b>						
Magnetic Field	B	Range of input field	–	–	1200	G
<b>ANGLE CHARACTERISTICS</b>						
Output <sup>[7]</sup>	RES <sub>ANGLE</sub>	Both 12 and 15 bit angle values are available via SPI	–	12/15	–	bit
Angle Refresh Rate <sup>[8]</sup>	t <sub>ANG</sub>	ORATE = 0	–	1.0	–	μs
Response Time <sup>[6]</sup>	t <sub>RESPONSE</sub>	Angular Latency; valid for ABI or UVW interface; ORATE = 0	–	7	–	μs
Angle Error	ERR <sub>ANG</sub>	T <sub>A</sub> = 25°C, ideal magnet alignment, B = 300 G, target rpm = 0	–1.0	±0.4	+1.0	degrees
		T <sub>A</sub> = 150°C, ideal magnet alignment, B = 300 G, target rpm = 0	–1.3	±0.6	+1.3	degrees
Temperature Drift	ANGLE <sub>DRIFT</sub>	T <sub>A</sub> = 150°C, B = 300 G, angle change from 25°C	–1.4	–	1.4	degrees
		T <sub>A</sub> = –40°C, B = 300 G, angle change from 25°C	–	0.9	–	degrees
Angle Noise <sup>[9]</sup>	N <sub>ANG</sub>	T <sub>A</sub> = 25°C, B = 300 G, no internal filtering, target rpm = 0, 3 sigma noise	–	±0.19	–	degrees
		T <sub>A</sub> = 150°C, no internal filtering, B = 300 G, target rpm = 0, 3 sigma noise	–	±0.25	–	degrees
Effective Resolution <sup>[10]</sup>		B = 300 G, T <sub>A</sub> = 25°C	–	12.5	–	bits
Angle Drift Over Lifetime <sup>[11]</sup>	ANGLE <sub>Drift_Life</sub>	B = 300 G, average maximum drift observed following AEC-Q100 qualification testing	–	0.5	–	degrees

[1] 1 G (gauss) = 0.1 mT (millitesla).

[2] Maximum operational voltage is reduced at high ambient temperatures (T<sub>A</sub>). See plots below.

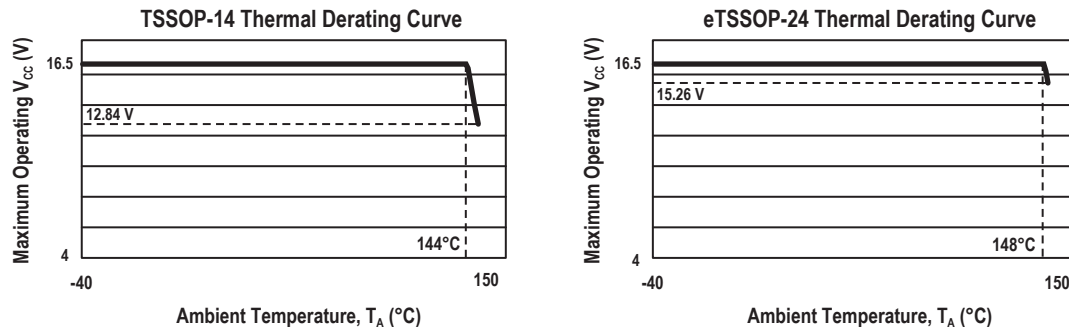

[3] Undervoltage flag indicates V<sub>CC</sub> level below expected operational range. Degraded sensor accuracy may result.

[4] During the power-on phase, the A1333 SPI transactions will be valid within ≈ 300 μs of power on (with no self-tests). Angle reading requires full t<sub>PO</sub> to stabilize.

[5] The output voltage specification is to aid in PCB design. The pin is not intended to drive any external circuitry. The specifications indicate the peak capacitor charging and discharging currents to be expected during normal operation.

[6] Parameter is not guaranteed at final test. Determined by design.

[7] RES<sub>ANGLE</sub> represents the number of bits of data available for reading from the die registers.

[8] The rate at which a new angle reading will be ready.

[9] This value represents 3-sigma or three times the standard deviation of the measured samples.

[10] Effective Resolution is calculated using the formula below:

$$\log_2(360) - \log_2\left(\frac{1}{n} \sum_{i=1}^n \sigma_i\right)$$

where σ is the Standard Deviation based on thirty averaged measurements taken at each of the 32 angular positions, I = 11.25, 22.5, ... 360.

[11] Maximum observed angle drift following AEC-Q100 stress was 1.37 degrees.



## TYPICAL PERFORMANCE CHARACTERISTICS

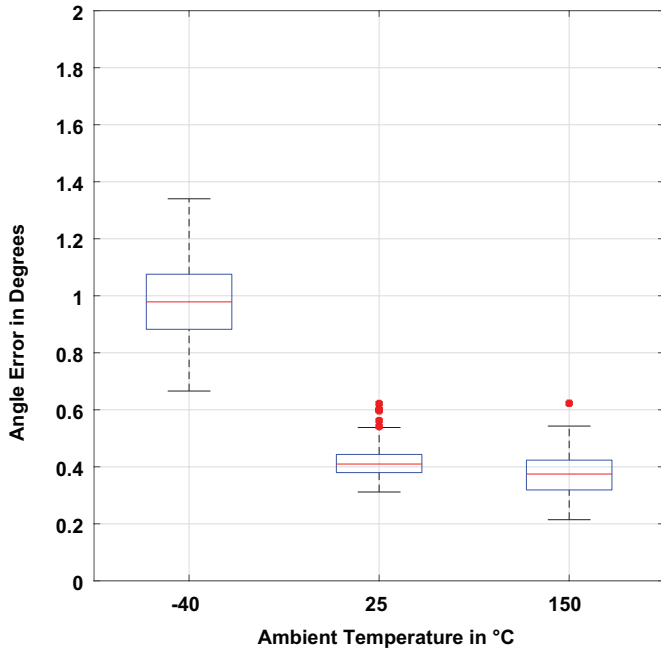

Figure 3: Peak Angle Error over Temperature [1] (300 G)

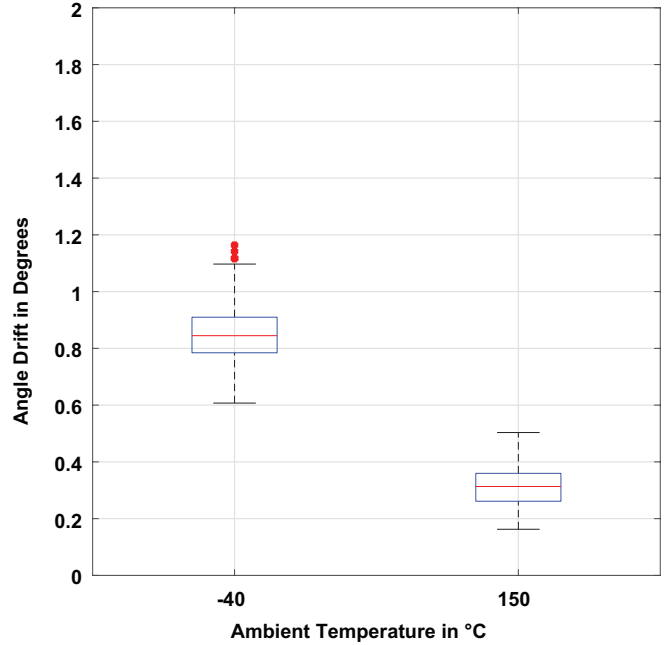

Figure 4: Maximum Absolute Drift from 25°C Reading [1] (300 G)

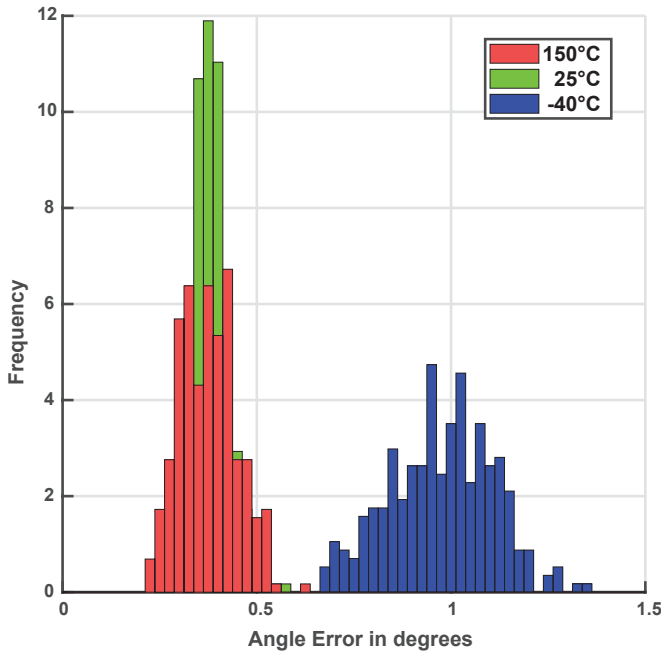

Figure 5: Peak Angle Error Distributions over Temperature (300 G)

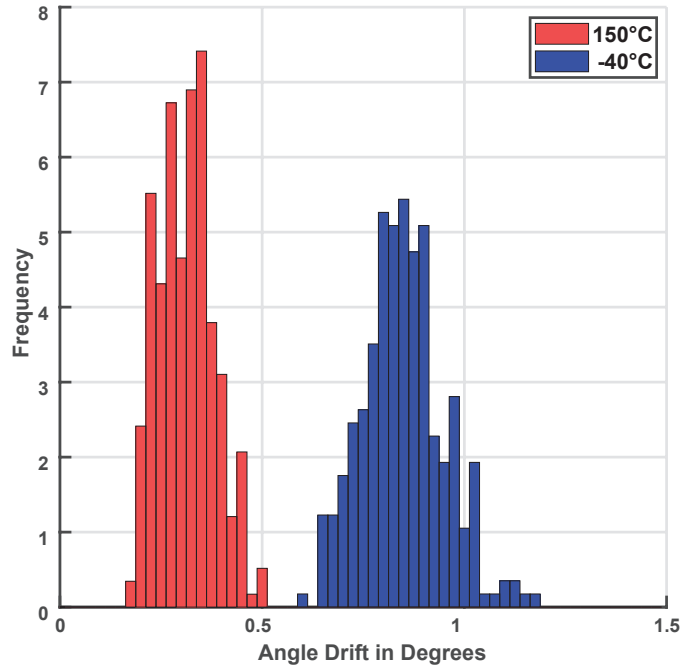

Figure 6: Angle Drift from 25°C (300 G)

[1] Central mark indicates median value. Bottom and top edges of the box indicate the 25th and 75th percentiles. Whiskers extend to the most extreme data points not defined as outliers. Outliers are shown in red. Outliers are defined as those points outside Q1 or Q3 by more than 1.5 times the inter-quartile range ( $\approx 2.7\sigma$  away from the center of the distribution).

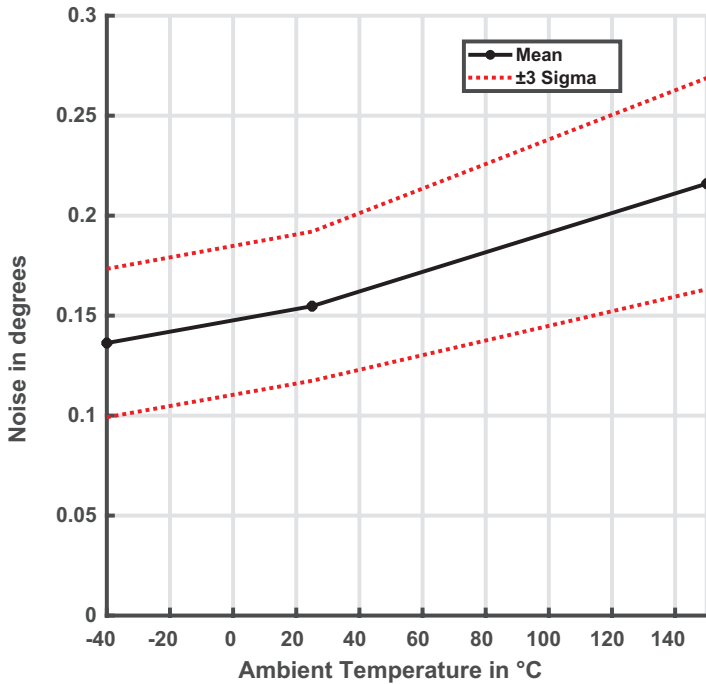

Figure 7: Noise Performance over Temperature (3 Sigma, 300 G)

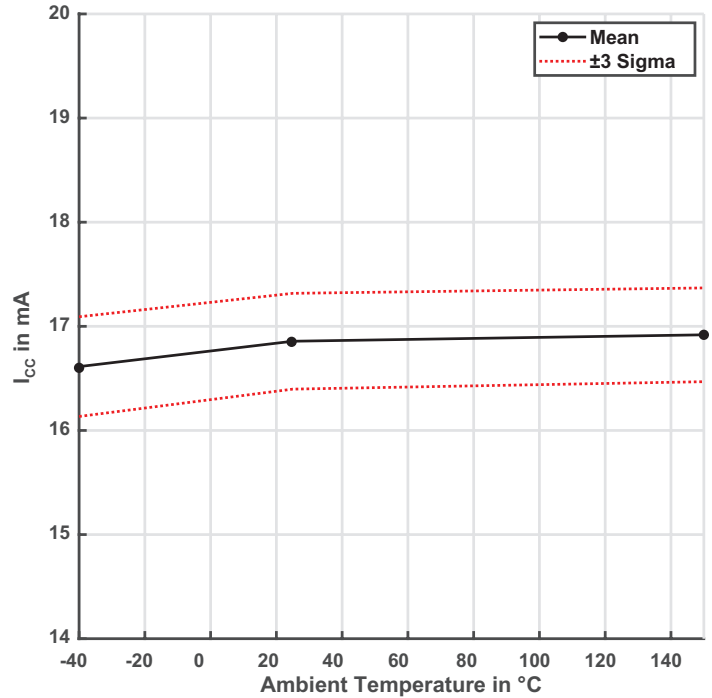

Figure 8: I<sub>CC</sub> over Temperature (V<sub>CC</sub> = 16.0 V)

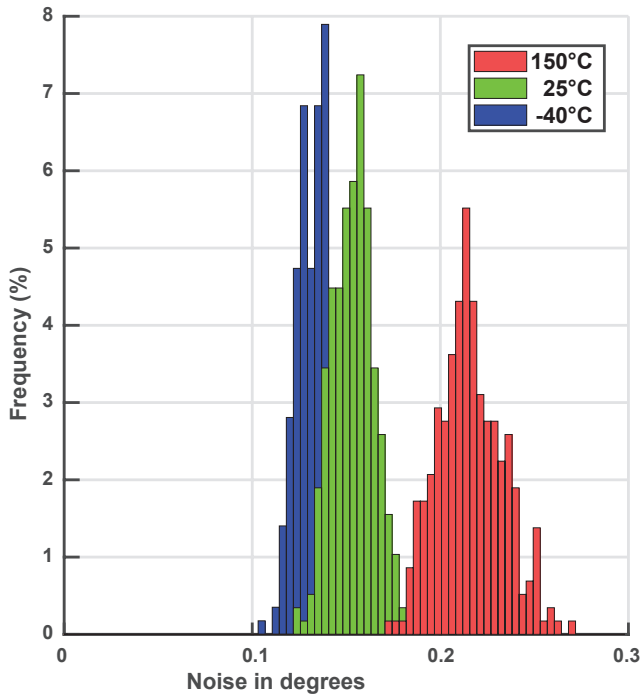

Figure 9: Noise Distribution over Temperature (3 Sigma, 300 G)

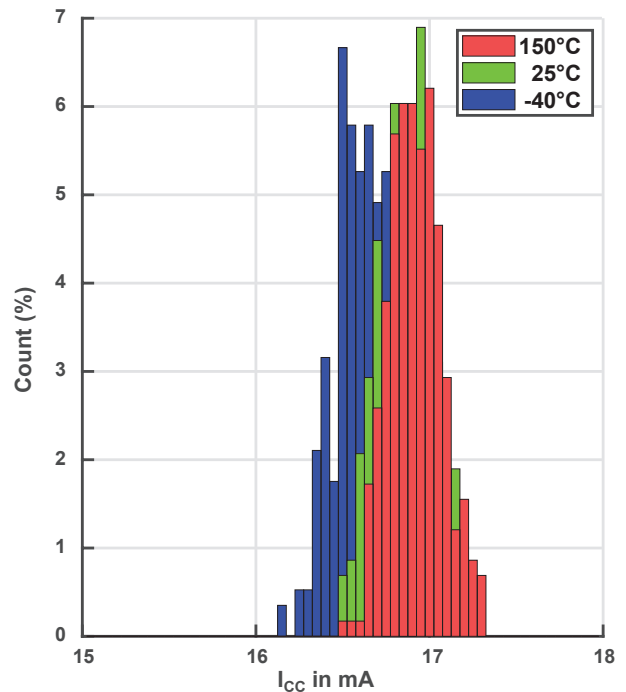

Figure 10: I<sub>CC</sub> Distribution over Temperature (V<sub>CC</sub> = 16.0 V)

TYPICAL PERFORMANCE OF FIELD AND TEMPERATURE

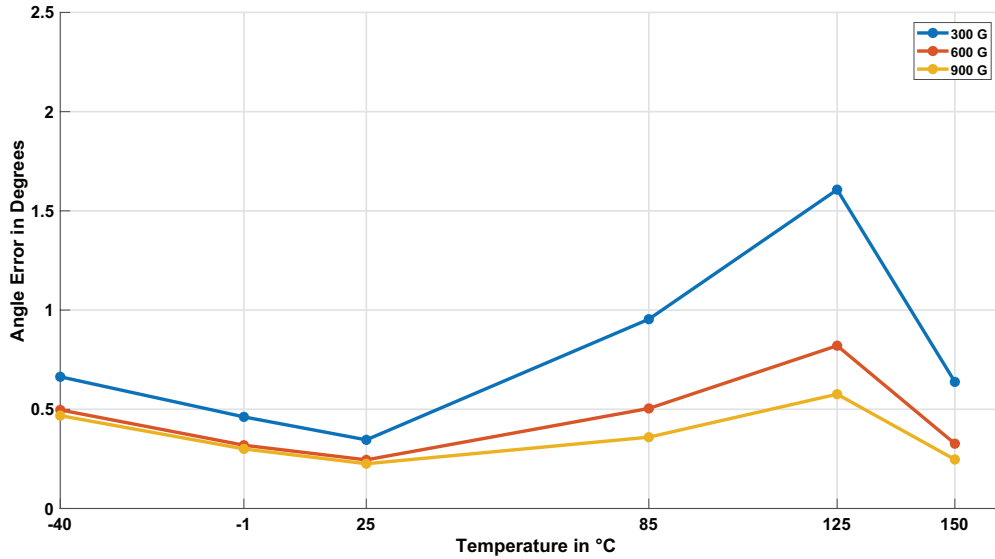

Figure 11: Average Angle Error over Temperature Across 10 Devices.

Recommended operating range: 300 G and above.

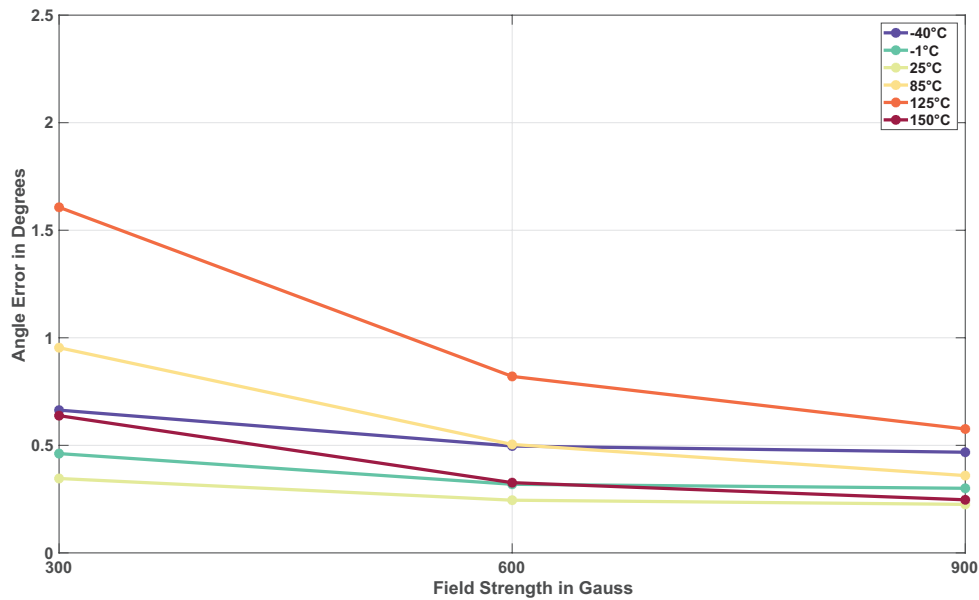

Figure 12: Average Angle Error over Field.

Recommended operating range: 300 G and above.

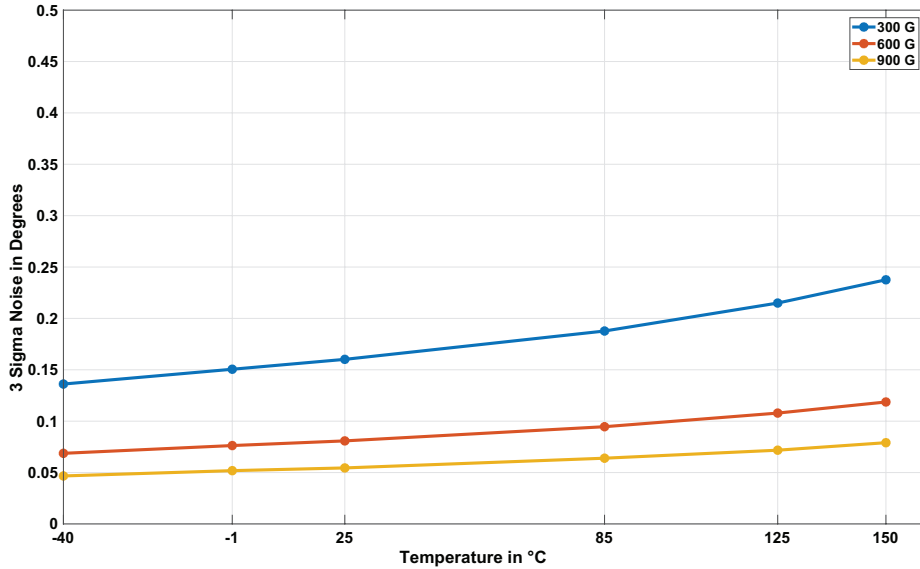

Figure 13: Average 3 Sigma Angle Noise over Temperature.

Recommended operating range: 300 G and above.

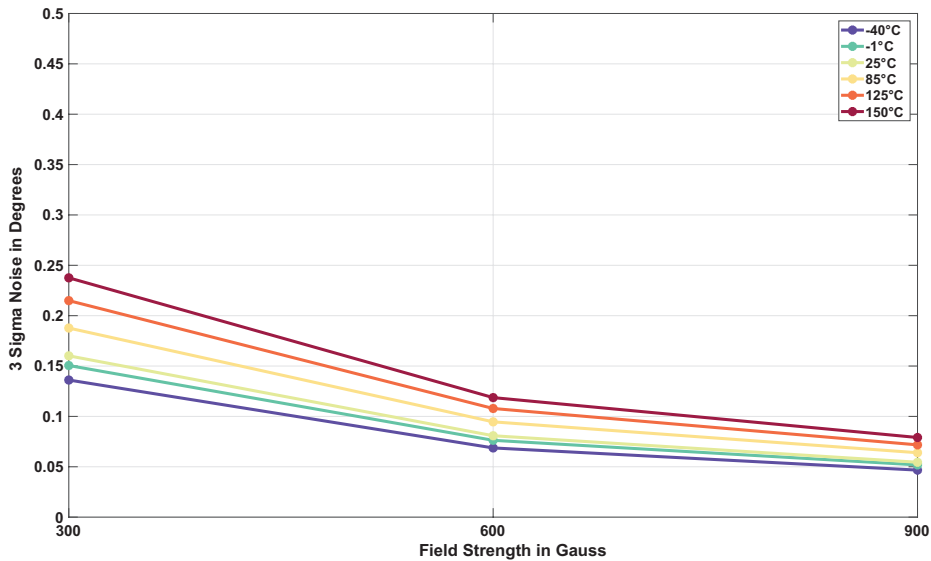

Figure 14: Average 3 Sigma Angle Noise over Field.

Recommended operating range: 300 G and above.

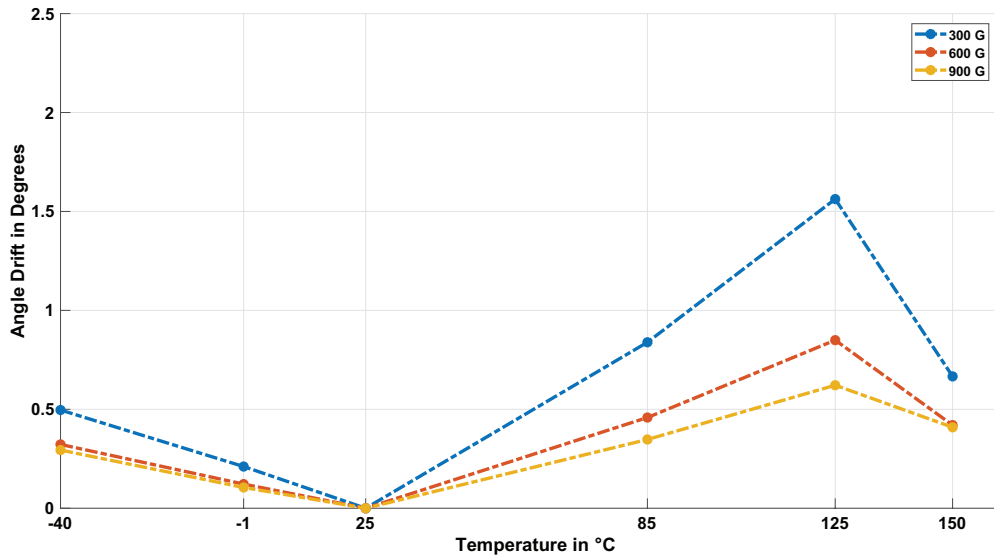

Figure 15: Average Angle Drift over Temperature Across 10 Devices.

Recommended operating range: 300 G and above.

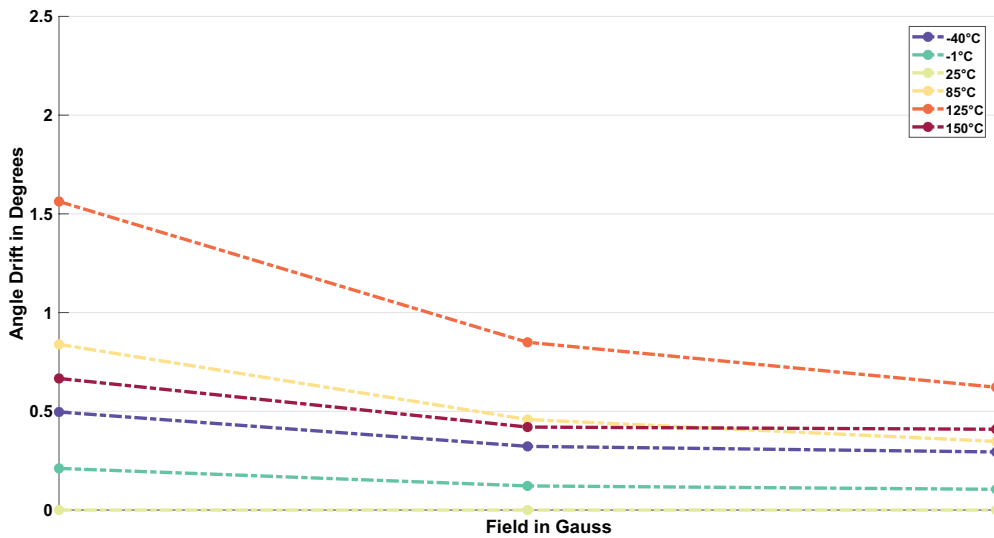

Figure 16: Average Angle Drift over Field Across 10 Devices.

Recommended operating range: 300 G and above.

## FUNCTIONAL DESCRIPTION

### Overview

The A1333 is a rotary position Hall-sensor-based device in a surface-mount package, providing solid-state consistency, reliability, and supporting a wide variety of automotive applications. The Hall-sensor-based device measures the direction of the magnetic field vector through 360° in the x-y plane (parallel to the branded face of the device) and computes an angle measurement based on the actual physical reading, as well as any internal parameters that have been set by the user. The output is used by the host microcontroller to provide a single channel of target data.

This device is an advanced, programmable system-on-chip (SoC). Each integrated circuit includes a Circular Vertical Hall (CVH) analog front end, a high-speed sampling A-to-D converter, digital filtering, digital signal processing (which includes two separate signal paths), SPI, PWM, motor commutation outputs (UVW), and encoder outputs (A, B, I).

Offset, filtering, and diagnostic adjustment options are available in the A1333. These options can be configured in onboard EEPROM, providing a wide range of sensing solutions in the same device. Device performance can be optimized by enabling individual functions or disabling them in EEPROM to minimize latency.

### Angle Measurement

The IC features two digital signal paths. The main signal path uses a PLL to generate high resolution, low latency angle readings. A secondary, lower power signal path (referred to as the “ZCD path”) is used for turns counting, magnetic field measurement, and diagnostic comparison.

The A1333 can monitor the angular position of a rotating magnet at speeds ranging from 0 to more than 15,000 rpm.

The A1333 has a typical refresh rate of 1 MHz.

Angle is represented as either a 12- or 15-bit value, based on the register address accessed.

#### 12 Bit Angle Value; Serial register 0x20

15	14	13	12	11	10	9	8	7	6	5	4	3	2	1	0
0	EF	UV	P	angle(11:0)											

#### 15 Bit Angle Value; Serial Register 0x32

15	14	13	12	11	10	9	8	7	6	5	4	3	2	1	0
0	angle(14:0)														

When reading the 12-bit angle value, 3 additional status bits are provided with each packet: a general error flag (EF), undervoltage flag (UV), and a parity bit (P).

PWM output is always resolved to a 12-bit angle value. ABI/UVW operates on a 15-bit angle representation.

The zero degree position may be adjusted by writing to EEPROM.

The sensor readout is processed in various steps. These are detailed in Figure 21.

### System Level Timing

Internal registers are updated with a new angle value every  $t_{\text{ANG}}$ . Due to signal path delay, the angle is  $t_{\text{RESPONSE}}$  old at each update. In other words,  $t_{\text{RESPONSE}}$  is the delay from time of magnet sampling until generation of a processed angle value. SPI, which is asynchronously clocked, results in a varying latency depending on sampling frequency and SCLK speed. The values which are presented to the user are latched on the first SCLK edge of the SPI response frame. This results in a variable age of the angle data, ranging from  $t_{\text{RESPONSE}} + t_{\text{SPI}}$  to  $t_{\text{RESPONSE}} + t_{\text{ANG}} + t_{\text{SPI}}$ , where  $t_{\text{SPI}}$  is the length of a read response packet, and  $t_{\text{ANG}}$  is the update rate of the angle register.

Similar to SPI, when using the PWM output, the output packet is not synchronized with the internal update rate of the sensor. The angle is latched at the beginning of the carrier frequency period (effectively at the rising edge of the PWM output). Because of this, the age of the angle value, once read by the system microcontroller, may be up to  $t_{\text{RESPONSE}} + t_{\text{ANG}} + 1/f_{\text{PWM}}$ .

Figure 20 shows the update rate and the signal delay of the different angle output paths depending on sensor settings.

The value of the “angle\_zcd” (ZCD signal path) register is updated approximately every 32  $\mu\text{s}$ . The field strength reading (register 0x2A) is updated approximately every 128  $\mu\text{s}$ .

### Impact of High Speed Sensing

Due to signal path latency, the angle information is delayed by  $t_{\text{RESPONSE}}$ . This delay equates to a greater angle value as the rotational velocity increases (i.e. a magnet rotating at 20,000 rpm traverses twice as much angular distance in a fixed time period as a magnet rotating at 10,000 rpm), and is referred to as angular lag.

The lag is directly proportional to rpm, and may be compensated for externally, if the velocity is known.

Angular lag can be expressed using the following equation:

$$Ang\_Lag = \frac{rpm \times 6}{1,000,000} \times t_{RESPONSE}$$

where *rpm* represents the rotational velocity of the magnet, *Angle\_Lag* is expressed in degrees, and *t<sub>RESPONSE</sub>* is in  $\mu$ s.

Figure 17 depicts the expected angular lag over rpm.

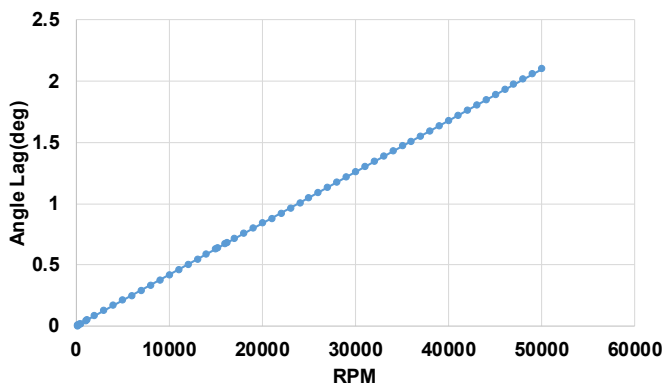

Figure 17: Expected Angle Lag vs. RPM

## Measured Performance Over RPM

Figure 18 and Figure 19 show the measured performance of the A1333 at speeds up to 12,000 rpm. Data taken with no internal averaging (ORATE = 0).

Figure 18 depicts the measured angle lag over increasing rpm. Data was collected by triggering SPI angle reads off a high precision encoder. To present data independent of output protocol, the delay due to SPI packet transmission has been removed from the plot. As such the plot shows the angle lag due to signal path delays only.

Figure 19 depicts the equivalent response time (in  $\mu$ s), derived from the slope of Figure 18. The measured response times ranges between 6.5 and 7.6  $\mu$ s.

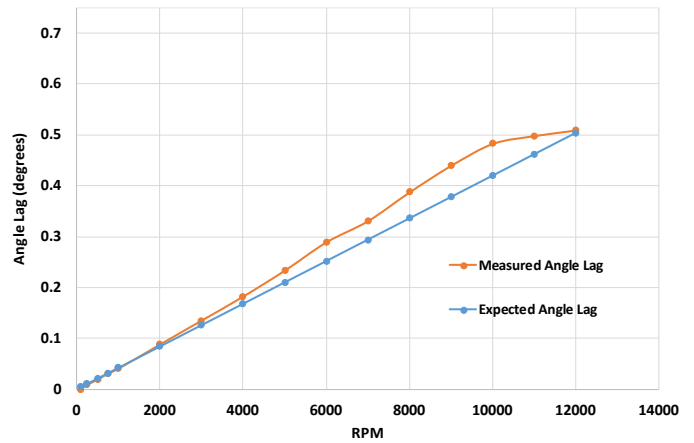

Figure 18: Measured Angle Lag vs. RPM

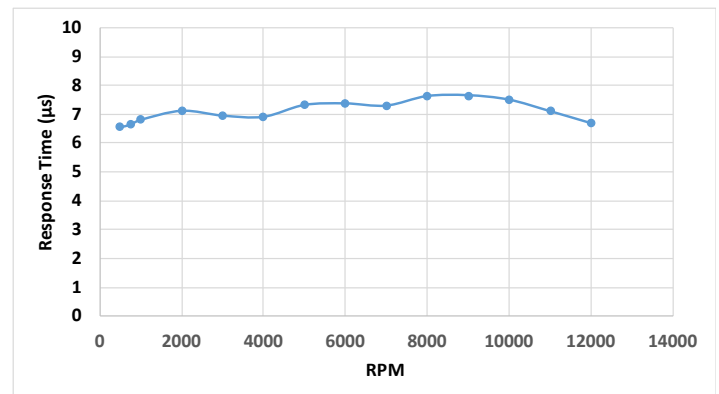

Figure 19: Measured Response Time Over RPM

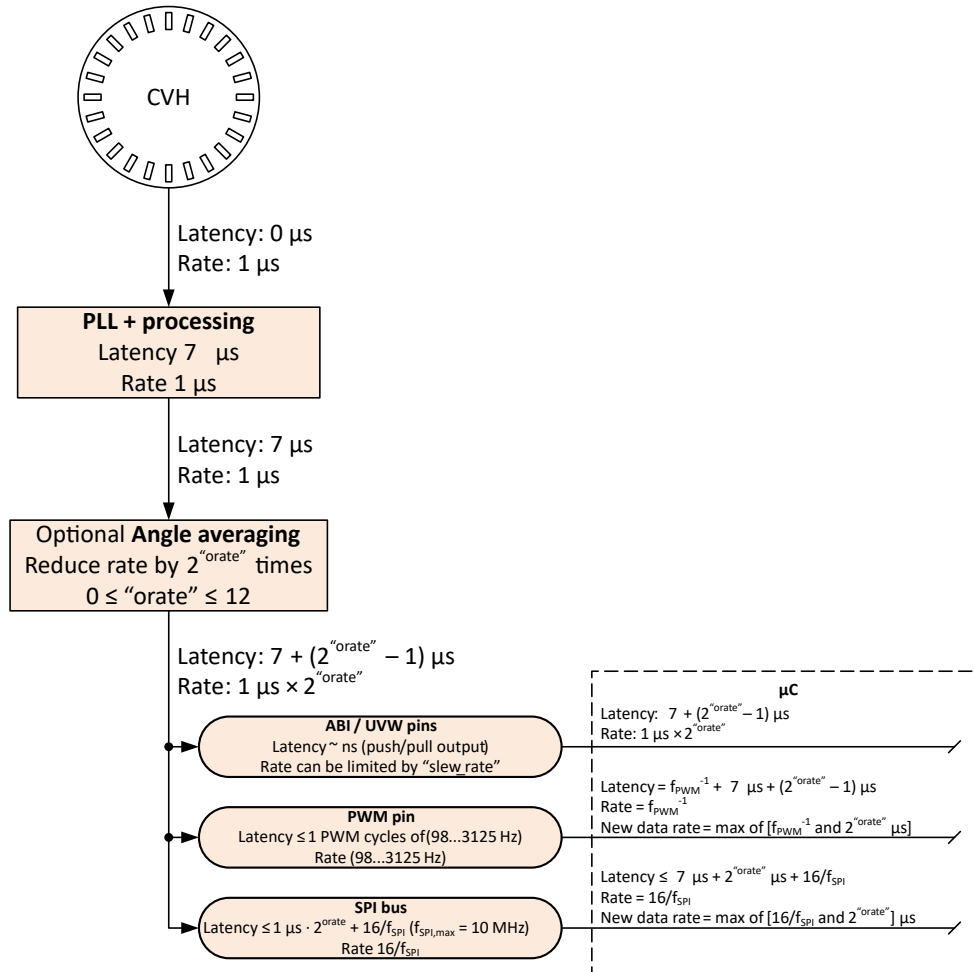

Figure 20: Update Rate and Signal Delay



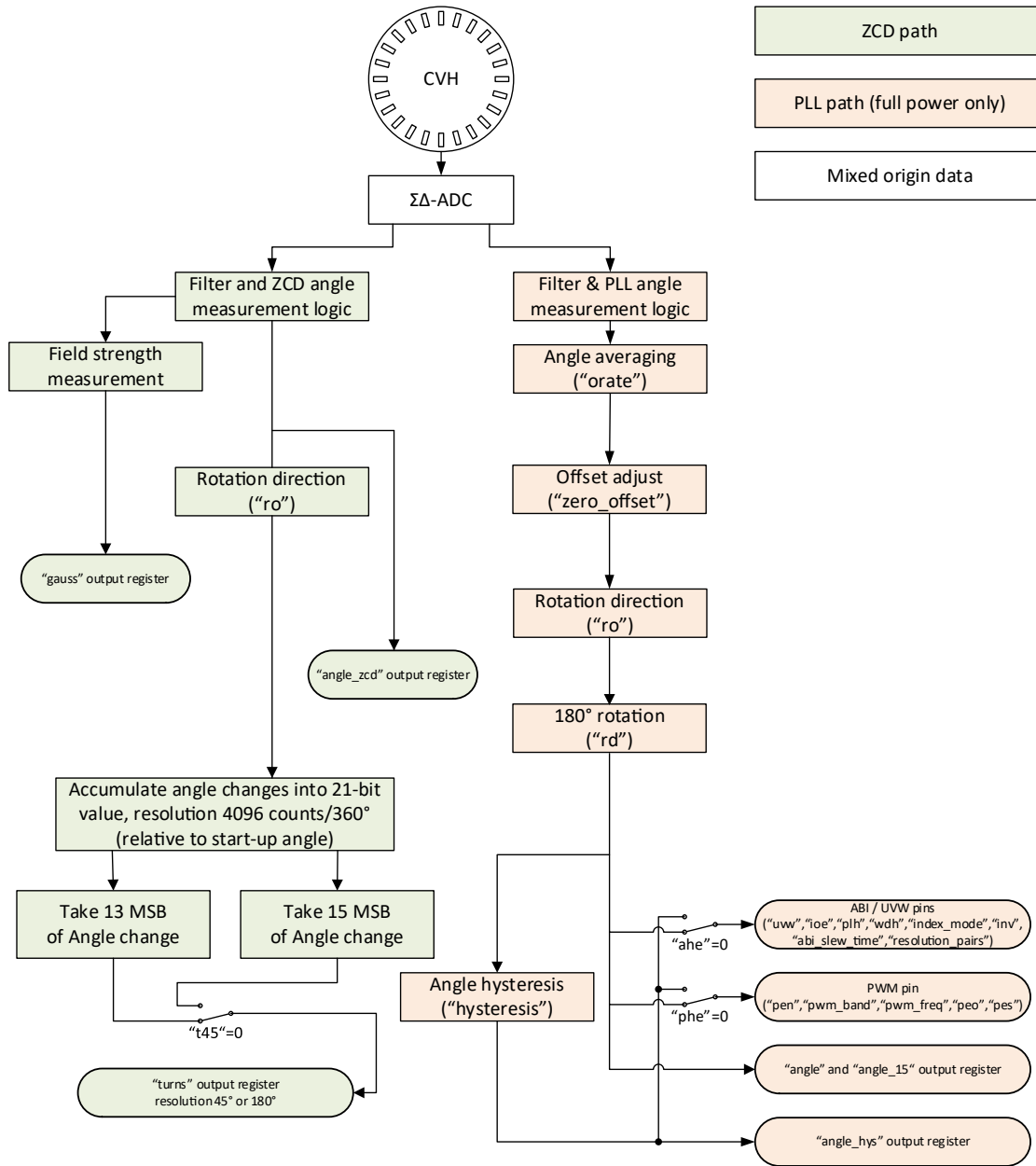

Figure 21: Angle Measurement – Sensor Readout Steps

Names in quotes correspond to EEPROM or serial register fields.

## Power-Up

Upon applying power to the A1333, the device automatically runs through an initialization routine. The purpose of this initialization is to ensure that the device comes up in the same predictable operating condition every power cycle. This initialization routine takes time to complete, which is referred to as Power-On Time,  $t_{PO}$ . Regardless of the state of the device before a power cycle, the device will re-power with the shadow memory contents copied from the EEPROM anew, and serial registers in their default states. For example, on every power-up, the device will power with the “zero\_offset” that was stored in the EEPROM. The extended write access field “write\_adr” will be set back to its default value, zero.

## PWM Output

The A1333 provides a pulse-width-modulated open-drain output, with the duty cycle (DC) proportional to measured angle. The PWM duty cycle is clamped at 5% and 95% for diagnostics purposes. A 5% DC corresponds to 0°; a 95% DC corresponds to 360°.

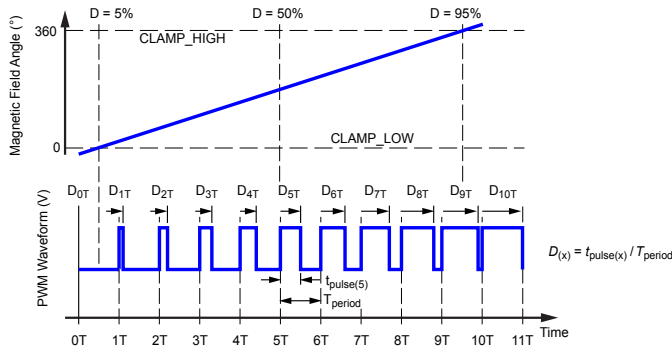

**Figure 22: PWM Mode Outputs a Duty-Cycle Proportional To Sensed Angle**

Within each cycle, the output is high for the first 5% and low for the last 5% of the period. The middle 90% of the period is a linear interpolation of the angle as sampled the start of the PWM period.

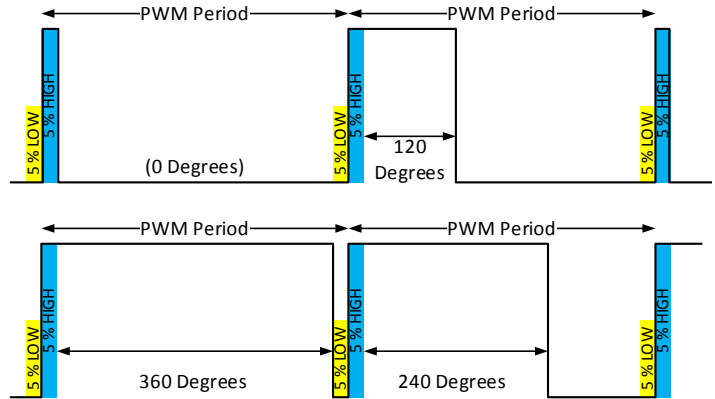

**Figure 23: Pulse-Width Modulation (PWM) Examples**

The angle is represented in 12-bit resolution and can never reach 360°. The maximum duty cycle high period is:

$$\text{DutyCycleMax (\%)} = (4095 / 4096) \times 90 + 5 .$$

## PWM CARRIER FREQUENCY

The PWM carrier frequency is controlled via two EEPROM fields, both of which are found in the PWS row.

- PWM\_FREQ
- PWM\_BAND

Together, these two fields allow 128 different PWM carrier frequencies to be selected.

**Table 1: PWM Carrier Frequencies in Hz**

		PWM_BAND							
		0	1	2	3	4	5	6	7
PWM_FREQ	0	3125	2778	2273	1667	1087	641	352	185
	1	3101	2740	2222	1613	1042	610	333	175
	2	3077	2703	2174	1563	1000	581	316	166
	3	3053	2667	2128	1515	962	556	301	157
	4	3030	2632	2083	1471	926	532	287	150
	5	3008	2597	2041	1429	893	510	275	143
	6	2985	2564	2000	1389	862	490	263	137
	7	2963	2532	1961	1351	833	472	253	131
	8	2941	2500	1923	1316	806	455	243	126
	9	2920	2469	1887	1282	781	439	234	121
	10	2899	2439	1852	1250	758	424	225	116
	11	2878	2410	1818	1220	735	410	217	112
	12	2857	2381	1786	1190	714	397	210	108
	13	2837	2353	1754	1163	694	385	203	105
	14	2817	2326	1724	1136	676	373	197	101
	15	2797	2299	1695	1111	658	362	191	98

### Incremental Output Interface (ABI)

The A1333 offers an incremental output mode in the form of quadrature A/B and Index outputs to emulate an optical or mechanical encoder. The A and B signals toggle with a 50% duty cycle (relative to angular distance, not necessarily time) at

a frequency of  $2^N$  cycles per magnetic revolution, giving a cycle resolution of  $(360 / 2^N)$  degrees per cycle, where N is set by the resolution\_pairs field in EEPROM; see Table 2. B is offset from A by  $1/4$  of the cycle period. The “I” signal is an index pulse that occurs once per revolution to mark the zero (0) angle position. One revolution is shown below:

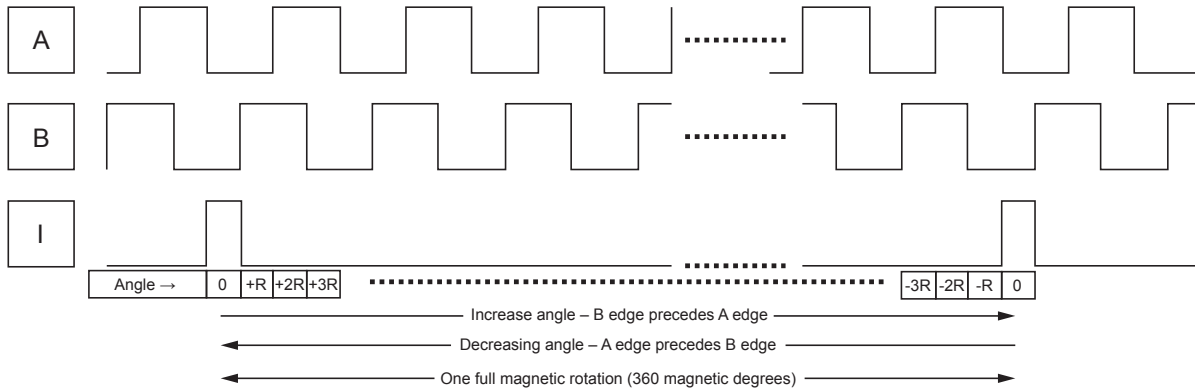

**Figure 24: One Full Magnetic Revolution**

Since A and B are offset by  $1/4$  of a cycle, they are in *quadrature* and together have four unique states per cycle. Each state represents  $R = [360 \div (4 \times 2^N)]$  degrees of the full revolution. This angular distance is the quadrature resolution of the encoder. The order in which the states change, or the order of the edge transitions from A to B, allow the direction of rotation to be determined. If a given B edge (rising/falling) precedes the following A edge, the angle is increasing from the perspective of the electrical (sensor) angle and the angle position should be incremented by the quadrature resolution (R) at each state transition. Conversely, if a given A edge precedes the following B edge, the angle is decreasing from the perspective of the electrical (sensor) angle and the angle position should be decremented by the quadrature resolution (R) at each state transition. The angle position accumulator wraps each revolution back to 0.

The quadrature states are designated as Q1 through Q4 in the following diagrams, and are defined as follows:

State Name	A	B
Q1	0	0
Q2	0	1
Q3	1	1
Q4	1	0

Note that the A/B progression is a grey coding sequence where only one signal transitions at a time. The state progression must be as follows to be valid:

Increasing angle: Q1 → Q2 → Q3 → Q4 → Q1 → Q2 → Q3 → Q4

Decreasing angle: Q4 → Q3 → Q2 → Q1 → Q4 → Q3 → Q2 → Q1

The duration of one cycle is referred to as 360 *electrical degrees*, or 360e. One half of a cycle is therefore 180e and one quarter of a cycle (one quadrature state, or R degrees) is 90e. This is the terminology used to express variance from perfect signal behavior. Ideally the A and B cycle would be as shown below for a constant velocity:

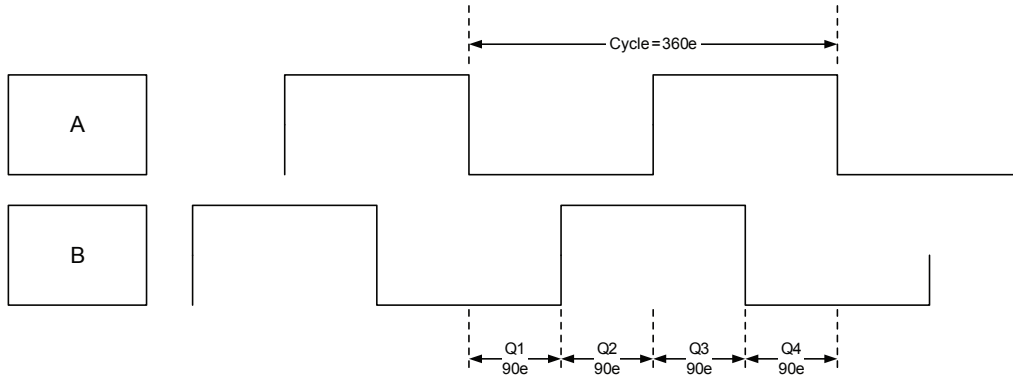

**Figure 25: Electrical Cycle**

In reality, the edge rate of the A and B signals, and the switching threshold of the receiver I/Os, will affect the quadrature periods:

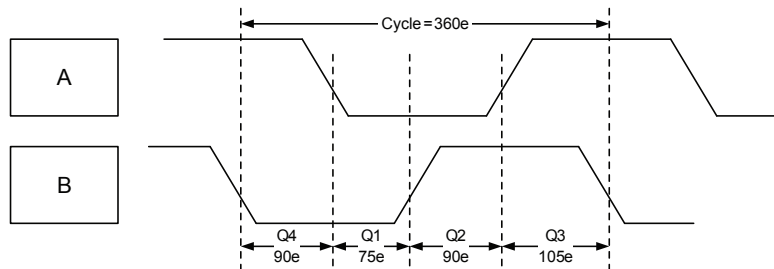

**Figure 26: Electrical Cycle**

Here, an exaggeration of the switching thresholds shows that Q4 and Q2, which are fall-fall and rise-rise, have the expected 90e period, whereas Q1 is less than expected and Q3 is greater than expected due to imbalance in switching thresholds.

### ABI RESOLUTION

The A1333 supports the following ABI output resolutions. This is set via the “resolution\_pairs” field in EEPROM and shadow (EEPROM 0x19, bits 3:0).

### ABI INVERSION

The logic levels of the ABI pins may be inverted by setting the ABI.inv bit within EEPROM. This also applies if using the UVW output logic.

**Table 2: ABI Output Resolution**

EEPROM Resolution Field	Cycle Resolution (Bits = N)	Quadrature Resolution (Bits = 4 × N)	Cycles per Revolution (A or B)	Quadrature States per Revolution	Cycle Resolution (Degrees)	Quadrature Resolution (R) (Degrees)
0	Factory Use Only					
1	Factory Use Only					
2	Factory Use Only					
3	11	13	2048	8192	0.176	0.044
4	10	12	1024	4096	0.352	0.088
5	9	11	512	2048	0.703	0.176
6	8	10	256	1024	1.406	0.352
7	7	9	128	512	2.813	0.703
8	6	8	64	256	5.625	1.406
9	5	7	32	128	11.250	2.813
10	4	6	16	64	22.500	5.625
11	3	5	8	32	45.000	11.250
12	2	4	4	16	90.000	22.5
13	1	3	2	8	180.0	45.0
14	0	2	1	4	360.0	90.0
15	n/a	n/a	n/a	n/a	n/a	n/a

### INDEX PULSE

The index pulse I (or Z in some descriptions) marks the absolute zero (0) position of the encoder. Under rotation, this allows the receiver to synchronize to a known mechanical/magnetic position, and then use the incremental A/B signals to keep track of the absolute position. To support a range of ABI receivers, the 'I' pulse has four widths, defined by the INDEX\_MODE EEPROM field, as shown below:

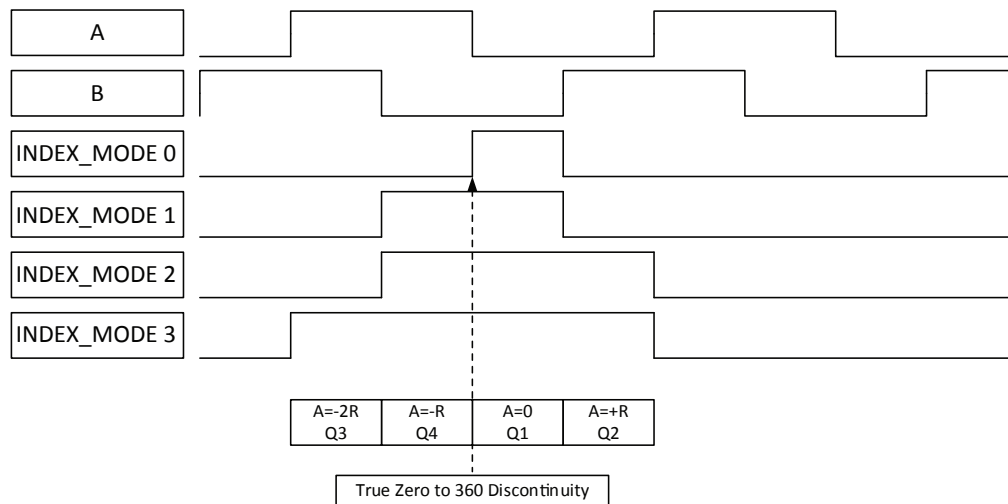

Figure 27: Index Pulse

### ABI BEHAVIOR AT POWER-UP

At power-up, the A1333 requires time to acquire a stable angle value; this is quantified by  $t_{PO}$  (or  $t_{PO,D}$ , if power-on diagnostics are used). Because the angle value is not guaranteed to be stable between power-on and  $t_{PO}$ , the output of the ABI should be ignored until at least  $t_{PO}$  after power-on.

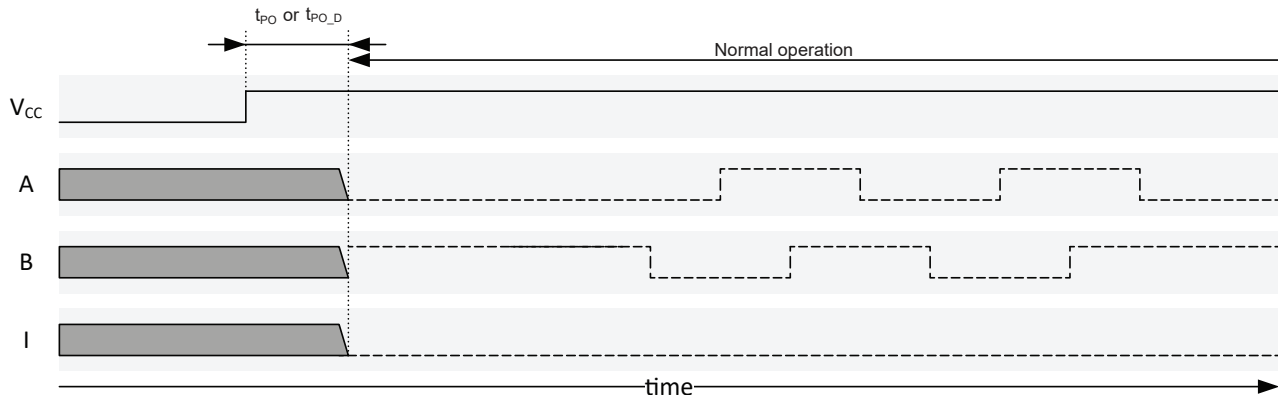

Figure 28: ABI Startup Behavior

## ZERO DEGREE POSITION INDICATION

The edge of the index pulse corresponding to the “Zero” position, as observed by the sensor, will change based on rotation direction, as shown in Figure 29.

With the magnet rotating such that the observed angle is increasing, the 0° position will be indicated by the rising edge of the Index pulse. If the

magnet is rotated in the opposite direction (or the RO bit is changed in EEPROM) to produce a decreasing angle value, the 0° position will be represented by the falling edge of the Index pulse.

The ABI resolution and I pulse mode selection (described above) determine the width of the Index pulse and the corresponding shift in zero position indication.

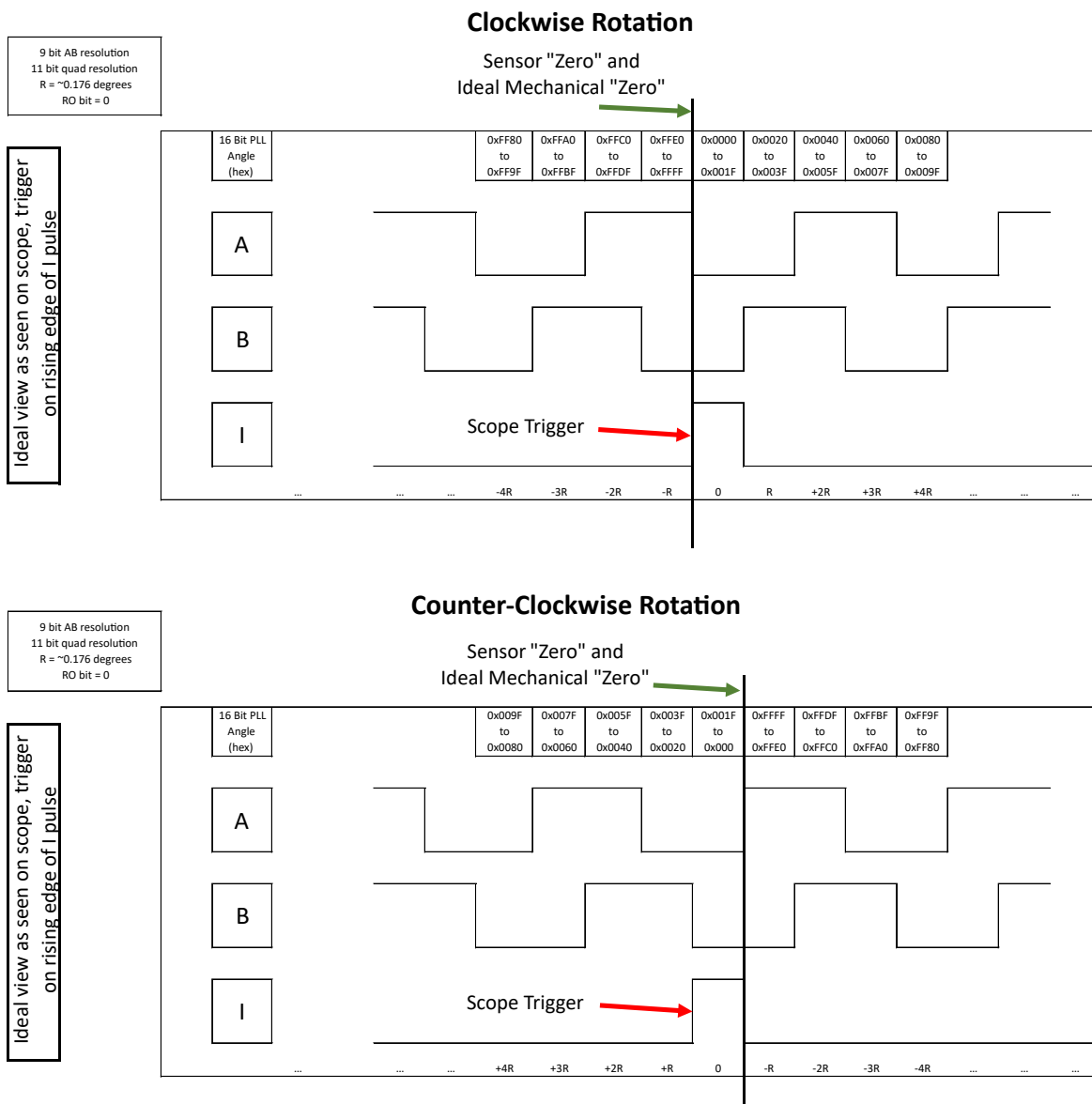

Figure 29: Index Pulse Corresponding to “Zero” Position

## SLEW RATE LIMITING FOR ABI

Slew rate limiting is enabled when the “abi\_slew\_time” field is non-zero. This option separates the sensor’s observed angle change from the ABI output rate, and can be used to control two circumstances:

- The angle sample does not monotonically increase or decrease at the quadrature resolution, thereby “skipping” one or more quadrature states. In this case, the slew rate limiting logic transitions the ABI signals in the required valid sequence, at the slew rate, until the ABI output “catches up” with the angle samples, at which point the normal sample rate output resumes. This skipping will most likely occur either at very low velocities, if the noise is high, or at very high velocities when the angle changes more than the quadrature resolution in one angle sample period.
- The ABI receiver at the host end cannot reliably detect edge transitions that are spaced at the sample rate of 1 μs. The slew limit time can be set greater than the nominal angle sample update period, providing the velocity of the angle rotation would not on average require ABI transitions greater than the angle sample rate.

In both cases, the ABI output will correctly track the rotation position; however, the speed of the ABI edges will be accomplished at the slew rate limit set in EEPROM. Whenever slew rate limiting occurs, the SRW flag in the WARN serial register will assert informing the system of the occurrence.

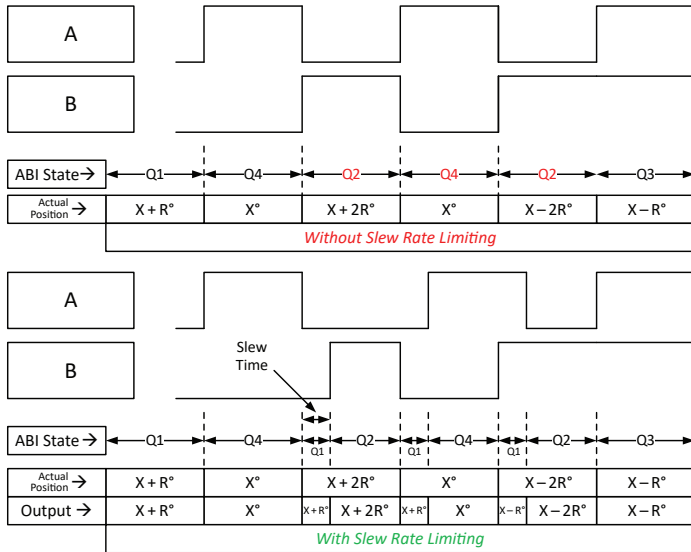

Figure 30: Slew Rate Limiting

## EFFECTIVE SPEED OF SLEW TIME

When slew rate limiting occurs, the ABI update rate is no longer dependent on the observed rotation rate, but instead occurs at a period set via EEPROM. This change in the edge rate will be observed as a change in the target velocity. This perceived velocity depends on:

- The configured “abi\_slew\_time” (EEPROM 0x19 bits 21:16)
- The ABI resolution (“resolution pairs” EEPROM 0x19 bits 3:0)

Table 3 shows the equivalent RPMs for select combinations of slew time and ABI resolution.

When designing a system, it is important to note these RPMs will occur for any change in rotation direction (i.e. motor transitioning from CW to CCW rotation), when both hysteresis and ABI slew rate limiting are enabled, as the IC “back fills” the ABI edges for the programmed hysteresis window (EEPROM 0x17 bits 17:12).

Table 3

EEPROM Setting		Equivalent RPM based on ABI Resolution		
abi_slew_time (Decimal)	Slew Time (μs)	12-bit Quadrature	11-bit Quadrature	10-bit Quadrature
1	0.25	58593.8	117187.5	234375.0
2	0.375	39062.5	78125.0	156250.0
3	0.5	29296.9	58593.8	117187.5
4	0.625	23,437.5	46875.0	93750.0
5	0.75	19531.3	39062.5	78125.0
6	0.875	16741.1	33482.1	66964.3
7	1	14648.4	29296.9	58593.8
8 (default)	1.125	13020.8	26041.7	52083.3
...	...	...	...	...
62	7.875	1860.1	3720.2	7440.5
63	8	1831.1	3662.1	7324.2



### Brushless DC Motor Output (UVW)

The A1333 offers U, V, and W signals for stator commutation of brushless DC (BLDC) motors. If hysteresis is enabled (set via “ahc”, bit 12 of EEPROM address 0x19), the UVW edges will update based off the rotation direction and hysteresis window. See the Hysteresis section of this document for greater detail. The U, V, and W outputs switch when the measured mechanical angle

crosses the value where a change should occur. By default, the UVW signals are 180° duty cycle waveforms (complete one cycle every 360°), spaced 120° apart. Options are provided for 1 to 16 pole-pairs, which control how many times the UVW waveforms are repeated for an observed mechanical rotation. This emulates the typical Hall switch output, from a multi pole-pair motor. Figure 32 and Figure 33 below show the UVW waveforms for three and five pole-pair BLDC motors.

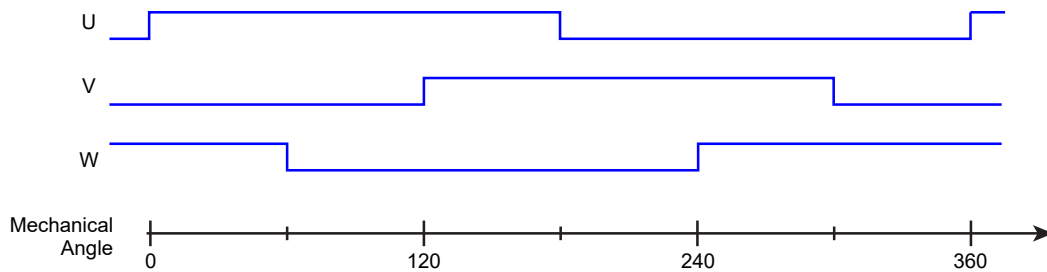

Figure 31: U, V, W Outputs for One Pole-Pair BLDC Motor

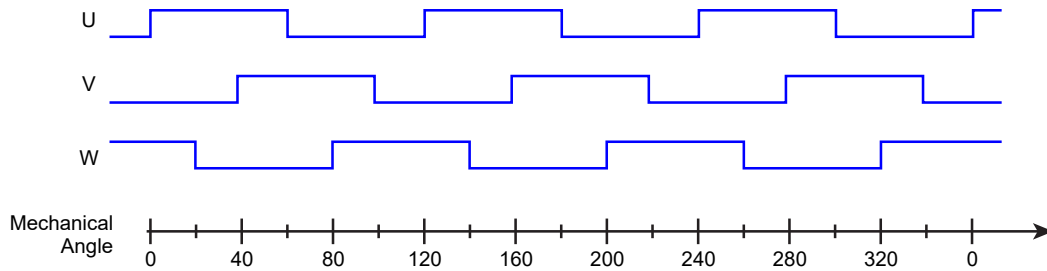

Figure 32: U, V, W Outputs for Three Pole-Pair BLDC Motor

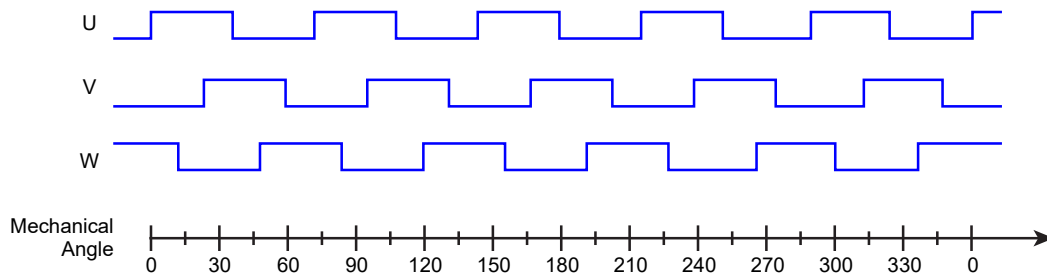

Figure 33: U, V, W Outputs for Five Pole-Pair BLDC Motor

**Table 4: UVW Pole Pair Settings**

resolution_pairs (hex)	Quantity of Pole-Pairs	Cycle Width (Mechanical Degrees)
0x0	1	360.00
0x1	2	180.00
0x2	3	120.00
0x3	4	90.00
0x4	5	72.00
0x5	6	60.00
0x6	7	51.43
0x7	8	45.00
0x8	9	40.00
0x9	10	36.00
0xA	11	32.73
0xB	12	30.00
0xC	13	27.69
0xD	14	25.71
0xE	15	24.00
0xF	16	22.50

## Angle Hysteresis

Hysteresis can be applied to the compensated angle to moderate jitter in the angle output due to noise or mechanical vibration. In the A1333, the hysteresis field (ANG.hysteresis) defines the width of an angle window at 14-bit resolution. Mathematically, the width of this window is:

$$HYSTERESIS \times (360 / 16384) \text{ degrees}$$

HYSTERESIS is a 6-bit wide EEPROM field, allowing a range of 0 to 1.384 degrees of hysteresis to be applied.

The hysteresis-compensated angle can be routed to the ABI or UVW interface by setting the AHE bit in EEPROM to a 1 (bit 12 of address 0x19). On the SPI or Manchester interface, the hysteresis-compensated angle can be read via an alternate register (HANG.angle\_hys) at 12-bit resolution.

The effect of the hysteresis is shown in Figure 34. The current angle position as measured by the sensor is at the “head” of the hysteresis window. As long as the sensor (electrical) angle

advances in the same direction of rotation, the output angle will be the sensor angle, minimizing latency. If the sensor angle reverses direction, the output angle is held static until the sensor angle exits the hysteresis window in either direction. If the exit is in the opposite direction of rotation where the “head” was, the head flips to the opposite end of the hysteresis window and that becomes the new reference direction. The current direction of rotation, or “head” for the purposes of hysteresis, is viewable via the STA.rot bit, where 0 is increasing angle direction and 1 is in decreasing angle direction.

This behavior has the following consequences:

1. If the hysteresis window is greater than the output resolution, the output angle will skip consecutive resolution steps.
2. If there is jitter due to noise or mechanical vibration, especially at a static angle position or very slow rotation, the angle will tend to bias to one side of the window, depending on the direction of rotation as the angular velocity approaches zero (i.e., towards the current “head”) rather than to the average position of the jitter.

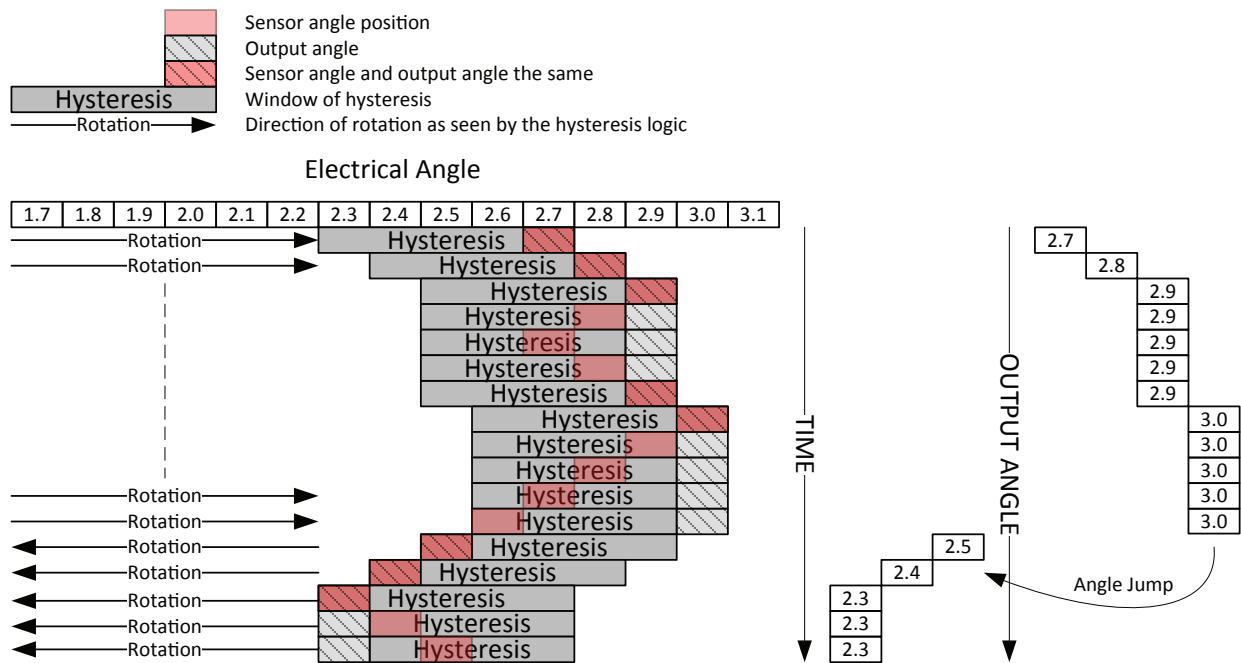

**Figure 34: Effect of Hysteresis**

Note: The rotation direction resets to 0, or increasing angle direction. At power-up or after LBIST, the hysteresis window will always be behind the initial angle position, so if hysteresis is enabled a decreasing angle direction of rotation will not register until the hysteresis window is past.

### Turns Counting

The A1333 uses a secondary, lower power signal path (called the “ZCD” path) to track rotation turns. The turns counter logic tracks the turns in either 45 or 180 degree increments, based on the T45 register field. The signal path which tracks total turns does not implement the same angle compensation as the primary signal path. Because of this, the turns count

value will not precisely match the primary angle output.

The turns counter saturates at +2047 and -2048 in the 45-degree mode and +511 and -512 in the 180-degree mode. If this happens, the Turns Count Warning Flag (bit 0 of serial register 0x26) will assert and stay asserted until the turns counter is reset via the Control register (serial register 0x1E). (see Primary Serial Interface Registers Reference section).

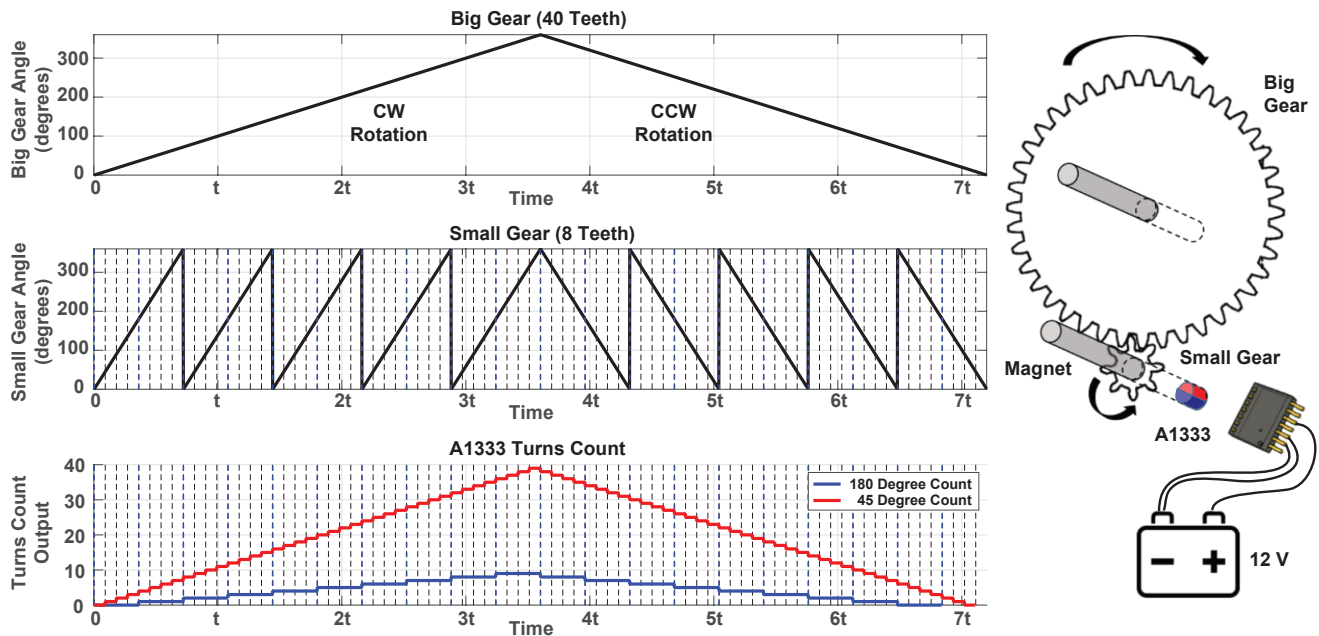

Figure 35: Example of a Turns Counting Application

### INVOKING A TURNS COUNTER RESET

Resetting the turns counter is a command invoked using the “special” field of the CTRL register (Register address 0x1E, see Primary Serial Interface Reference). Following a reset, turns are tracked relative to that point, as measured by the signal path (ZCD).

## DEVICE PROGRAMMING INTERFACES

The A1333 can be programmed in two ways:

- Using the *SPI interface* for input and output, while supplying the VCC pin with normal operating voltage
- Using a *Manchester protocol* on the supply pin for input, and the PWM pin for output.

The A1333 does not require special supply voltages to write to the EEPROM.

All setting fields and all data fields of the sensor can be read and written using both protocols. If EEPROM locking is used (detailed in EEPROM lock section), then write access using either of the protocols will be prevented.

A separate setting to completely disable the Manchester interface is available in the dm field of the EEPROM. Using this setting will cause the sensor to ignore any commands entered using Manchester protocol. The SPI interface will not be disabled by disabling the Manchester interface.

### Interface Structure

The A1333 consists of two memory blocks. The primary serial interface registers are used for direct writes and reads by the host controller for frequently required information (for example, angle data, warning flags, field strength, and temperature). All forms of communication (even to the extended locations) operate through the primary registers, whether it be via SPI or Manchester.

The primary serial registers also provide a data and address location for accessing extended memory locations. Accessing these extended location is done in an indirect fashion: the controller

writes into the primary interface to give a command to the sensor to access the extended locations. The read/write is executed and the result is again presented in the primary interface.

This concept is shown in Figure 36 below.

For writing extended locations, the primary interface offers the registers “ewcs”, “ewa”, “ewdh”, and “ewdl”. “ewa” holds the extended address that should be written, and “ewdh” / “ewdl” contain the two high bytes and the two low bytes for the extended location contents. The “ewcs” register is used for commands and status information. Refer to the section “Read Transaction from EEPROM” for further information and other register fields associated with read transactions.

For reading extended locations, the primary interface offers the registers “ercs”, “era”, “erdh”, and “erdl”. “era” holds the extended address the should be read, and “erdh” / “erdl” contain the two high bytes and the two low bytes for the extended location contents. The “ercs” register is used for commands and status information. Refer to the section “Read Transaction from EEPROM” for further information and other register fields associated with read transactions.

EEPROM writing requires additional procedures. For more information on EEPROM and shadow memory read and write access, see EEPROM and Shadow Memory section.

The primary serial interface can be accessed using the SPI and using the Manchester interface. These two interfaces are detailed in the following sections.

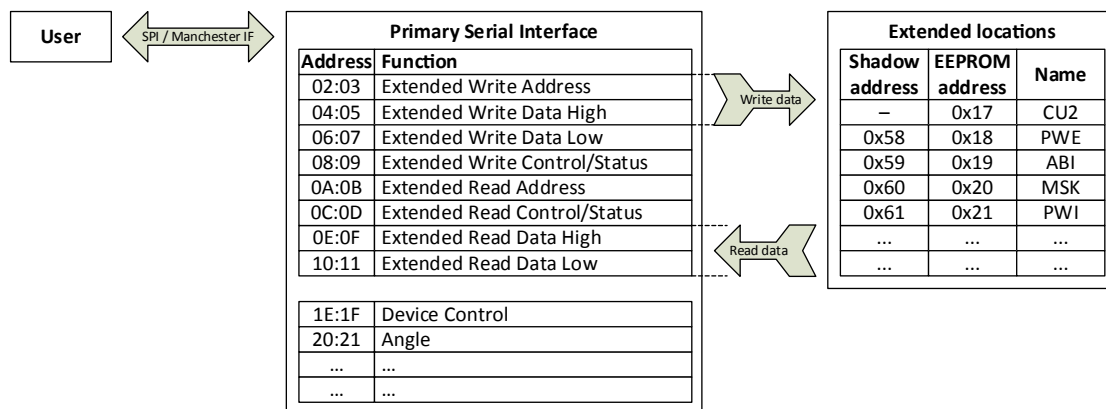

Figure 36: Serial Registers allow access to extended memory (EEPROM and Shadow)

## SPI Interface

The A1333 provides a full-duplex 4-pin SPI interface for each die, using SPI mode 3 (CPHA = 1, CPOL = 1). All programming can be done using this interface, but all programming can also be done using the Manchester interface. If the SPI interface is not used, do not leave the chip select line floating but instead follow the recommendations in the “Typical Application Diagram” section.

The sensor responds to commands received on the MOSI (Master-Out Slave-In), SCLK (Serial Clock), and CSx (Chip Select) pins, and outputs data on the MISO (Master-In Slave-Out) pin. All three input pins are 3.3 V and 5 V SPI compatible, with threshold values determined by factory EEPROM settings. MISO output voltage level will conform to 3.3 V or 5 V SPI levels, based on factory settings. Regular part are shipped with 3.3 V interface. Contact Allegro for ordering options of the 5 V variant.

The setup for communication using the SPI interface is given below.

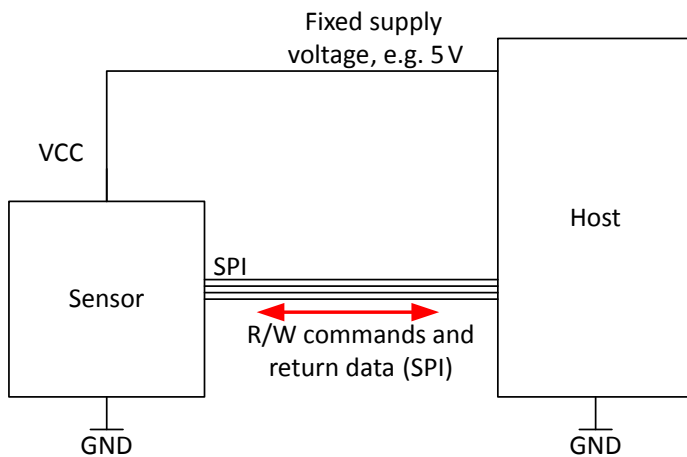

Figure 37: SPI Interface Programming Setup

## TIMING

The interface timing parameters from the specification table are defined in the figures below.

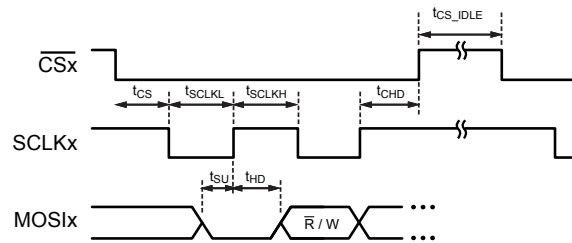

Figure 38: SPI Interface Timings Input

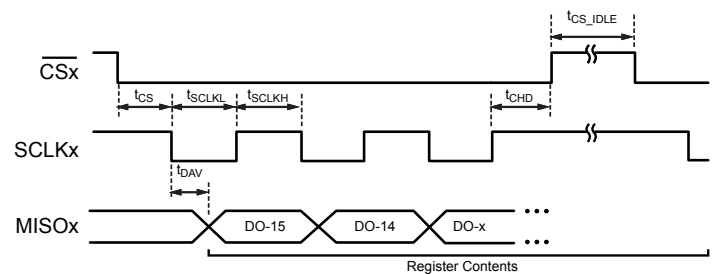

Figure 39: SPI Interface Timings Output

## SPURIOUS INTERFACE ERROR (IER) WHEN SHARING SPI LINES

The IER error flag may provide an erroneous indication when the SCLK line is shared amongst multiple ICs. Ways to avoid this are detailed in Appendix B.

Characteristics	Symbol	Test Conditions	Min.	Typ.	Max.	Unit
<b>SPI INTERFACE SPECIFICATIONS (for 3.3 V SPI Mode)</b>						
Digital Input High Voltage	$V_{IH}$	MOSI, SCLK, $\overline{CS}$ pins	2.8	–	3.63	V
Digital Input Low Voltage	$V_{IL}$	MOSI, SCLK, $\overline{CS}$ pins	–	–	0.5	V
SPI Output High Voltage	$V_{OH}$	MISO pins, $C_L = 20$ pF, $T_A = 25^\circ\text{C}$ , 5 V compliant	2.93	3.3	3.63	V
SPI Output Low Voltage	$V_{OL}$	MISO pins, $C_L = 20$ pF	–	0.3	–	V
<b>SPI INTERFACE SPECIFICATIONS (for 5.0 V SPI Mode) (Contact Allegro for 5 V SPI ordering information)</b>						
Digital Input High Voltage	$V_{IH}$	MOSI, SCLK, $\overline{CS}$ pins	3.75	–	5.5	V
Digital Input Low Voltage	$V_{IL}$	MOSI, SCLK, $\overline{CS}$ pins	–	–	0.5	V
SPI Output High Voltage	$V_{OH}$	MISO pins, $C_L = 20$ pF, $T_A = 25^\circ\text{C}$ , $V_{CC} \geq 5.0\text{V}$	4	5	5.5	V
SPI Output Low Voltage	$V_{OL}$	MISO pins, $C_L = 20$ pF	–	0.3	–	V
<b>SPI INTERFACE SPECIFICATIONS</b>						
SPI Clock Frequency <sup>[1]</sup>	$f_{SCLK}$	MISO pins, $C_L = 20$ pF	0.1	–	10	MHz
SPI Clock Duty Cycle <sup>[1]</sup>	$D_{fSCLK}$	$SPI_{CLKDC}$	40	–	60	%
SPI Frame Rate <sup>[1]</sup>	$t_{SPI}$		5.8	–	588	kHz
Chip Select to First SCLK Edge <sup>[1]</sup>	$t_{CS}$	Time from $\overline{CS}$ going low to SCLK falling edge	50	–	–	ns
Chip Select Idle Time <sup>[1]</sup>	$t_{CS\_IDLE}$	Time $\overline{CS}$ must be high between SPI message frames	200	–	–	ns
Data Output Valid Time <sup>[1]</sup>	$t_{DAV}$	Data output valid after SCLK falling edge	–	30	–	ns
MOSI Setup Time <sup>[1]</sup>	$t_{SU}$	Input setup time before SCLK rising edge	25	–	–	ns
MOSI Hold Time <sup>[1]</sup>	$t_{HD}$	Input hold time after SCLK rising edge	50	–	–	ns
SCLK to CS Hold Time <sup>[1]</sup>	$t_{CHD}$	Hold SCLK high time before $\overline{CS}$ rising edge	5	–	–	ns
Load Capacitance <sup>[1]</sup>	$C_L$	Loading on digital output (MISO) pin	–	–	20	pF

<sup>[1]</sup> Parameter is not guaranteed at final test. Determined by design.

## MESSAGE FRAME SIZE

The SPI interface requires either 16, 17, or 20-bit packet lengths. An extended 20-bit SPI packet allows 4 bits of CRC to accompany every data packet. A 17-bit packet is only allowed if the EEPROM/Shadow bit “s17” (bit 1 of EEPROM 0x1B) is set to 1.

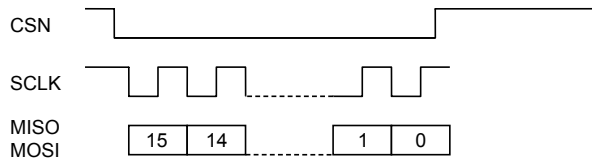

**Figure 40: Sixteen Bit SPI Transaction**

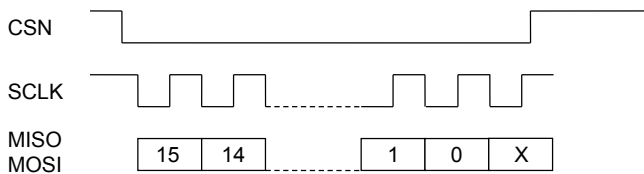

**Figure 41: Seventeen Bit SPI Transaction**

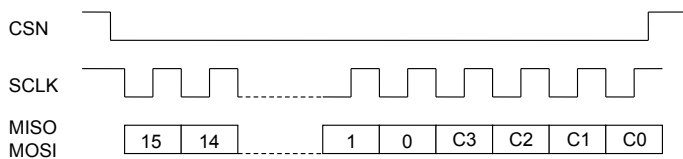

**Figure 42: Twenty Bit SPI Transaction**

If more clock pulses than expected were detected by the sensor in an SPI transaction, the interface warning “warn.ier” will activate. This warning will not activate on clean SPI transactions with 16 or 20 bit, or with clean 17-bit transactions when “s17” is enabled.

The purpose of the 17-bit SPI option is to allow delayed reading of the MISO line by the host. Some host allow to sample data from the slave not on the rising edge, but on the next falling edge of SCLK. This way, in case of long interface delays caused by large line capacitance or very long cables, the permissible clock speed can be increased. However, a 17th falling edge is required to read the 16th bit coming from the sensor. For the sensor to not display an error when this 17th clock is found, the bit “s17” must be set.

## 21-BIT SPI PACKET

If sharing an SPI bus, the A1333 may exhibit a false IER flag when using the standard SPI packet sizes. To prevent this, a 21-bit SPI packet should be used.

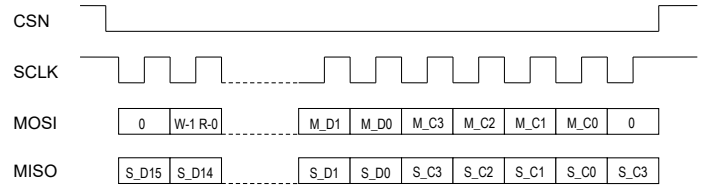

**Figure 43: Twenty-One Bit SPI Transaction**

The 21<sup>st</sup> bit sent from the master should be a logic ‘0’, effectively left-shifting the standard 20-bit packet by 1 bit. The IC’s response will repeat the most significant bit of the CRC, shifted out on the last SCLK edge. See Appendix B for more information.

## WRITE CYCLE

Write cycles consist of a 1-bit low, a 1-bit R/W (write = high), 6 address bits (corresponding to the primary serial register), 8 data bits, and 4 optional CRC bits. To write a full 16-bit serial register, two write commands are required (even and odd byte addresses). MOSI bits are clocked in on the rising edge of the Master-generated SCLK signal.

## READ CYCLE

Reading data always involves at least two SPI frames. In the first frame, the read command is sent, while in the second frame, the result from the first read is received. While receiving data from the last read command, it is possible to send another read command (duplexed read). This way, every frame except the first one contains data from the sensor. This is useful for very fast reading of angle information.

When receiving the last frame, the host can transmit a command with MOSI set to all zeros. This represents a read command from register 0x00 and will not cause any reaction from the sensor. Reading from register 0x00 will output the value 0x0000.

In frames where no previous read command was sent, the MISO data output should be ignored.



Because an SPI read command can transmit 16 data bits at one time, and the primary serial registers are built from one even and one odd byte, the entire 16-bit contents of one serial register may be transmitted with one SPI frame. This is accomplished by providing an even serial address value. If an odd value address is sent, only the contents of the single byte will be returned, with

the eight most significant bits within the SPI packet set to zero. Example: To read all 16 bits of the error register (0x24:0x25), an SPI read request using address 0x24 should be sent. If only the 8 LSBs are desired, the address 0x25 should be used. Figure 44 shows examples of both an SPI write and an SPI read request, using a 16-bit SPI message frame.

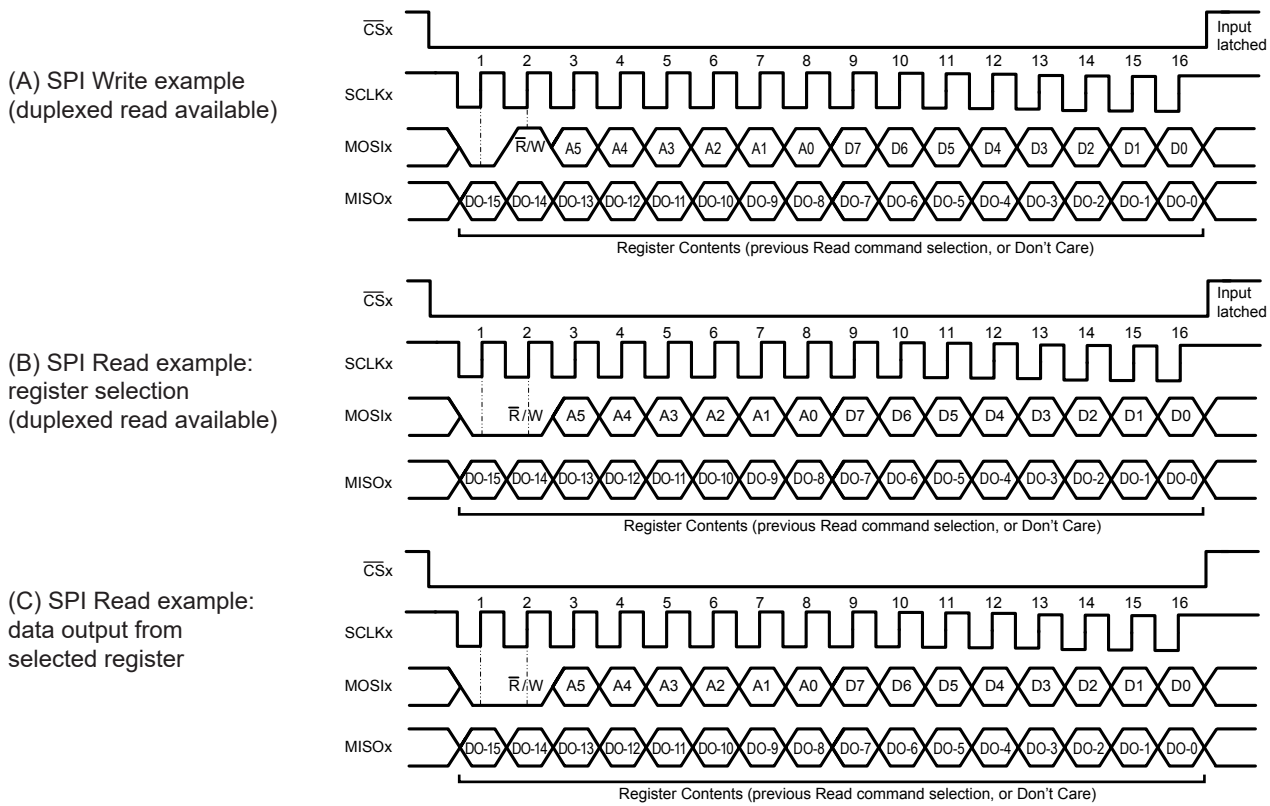

**Figure 44: SPI Read and Write Pulse Sequences**

**CRC**

If the user want to check the data coming from the sensor, it is possible to use 20-bit SPI frames. Without additional setting required, a 4-bit CRC is automatically generated and placed on the MISO line if more than 16 bits are read from the sensor.

The four additional CRC bits on the MOSI line coming from the host are ignored by the sensor, unless the “PWI.sc” bit is set within EEPROM (0x1B, bit 0). When the incoming CRC check is enabled, an incoming SPI packet with an incorrect CRC will be discarded, and the CRC error flag set in serial register “warn.crc”.

The CRC is based on the polynomial  $x^4 + x + 1$  with the linear feedback shift register preset to all 1s. The 16-bit packet is shifted through from bit 15 (MSB) to bit 0 (LSB). The CRC logic is shown in Figure 45. Data are fed into the CRC logic with MSB first. Output is sent as C3-C2-C1-C0.

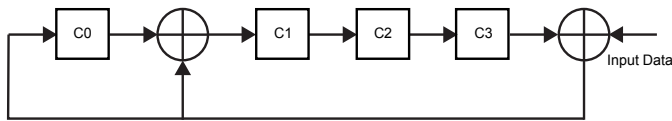

**Figure 45: SPI CRC**

The CRC output by the sensor on the MISO pin will always be correct. The CRC from the host on the MOSI pin must be correct if the CRC enable bit PWI.sc in the EEPROM was set.

Note: If the ERD (extended read data) register is read before the “ERCS.ERD” bit indicates a read has completed, there is a possibility of a CRC error, as the data could change during the read. Do not read the ERD register until it is known to be stable based on the done bit indication or waiting sufficient time.

The CRC can be calculated with the following C code:

```
/*
 * CalculateCRC
 *
 * Take the 16-bit input and generate a 4-bit CRC
 * Polynomial = x^4 + x + 1
 * LFSR preset to all 1's
 */
uint8_t CalculateCRC(uint16_t input)
{
    bool CRC0 = true;
    bool CRC1 = true;
    bool CRC2 = true;
    bool CRC3 = true;
    int i;
    bool DoInvert;
    uint16_t mask = 0x8000;

    for (i = 0; i < 16; ++i)
    {
        DoInvert = ((input & mask) != 0) ^ CRC3;
        CRC3 = CRC2;
        CRC2 = CRC1;
        CRC1 = CRC0 ^ DoInvert;
        CRC0 = DoInvert;
        mask >>= 1;
    }

    return (CRC3 ? 8U : 0U) + (CRC2 ? 4U : 0U) + (CRC1 ? 2U
: 0U) + (CRC0 ? 1U : 0U);
}
```

## Manchester Interface

To facilitate addressable device programming when using the unidirectional PWM, ABI, or UVW protocols, with no need for additional wiring, the A1333 incorporates a serial interface on the VCC line (Note: The A1333 may also be programmed via SPI, with additional wiring connections).

This interface allows an external controller to read and write registers in the A1333 EEPROM and volatile memory. The device uses a point-to-point communication protocol, based on Manchester encoding per G.E. Thomas (a rising edge indicates a 0 and a falling edge indicates a 1), with address and data transmitted MSB first. The addressable Manchester code implementation uses the logic states of the SA0/SA1 pins to set address values for each die. In this way, individual communication with up to four A1333 dies is possible. To prevent any undesired programming of the A1333, the serial interface can be disabled by setting the Disable Manchester bit, “PWI.dm”, to 1. With this bit set, the sensor will ignore any Manchester input on VCC.

The setup for communication using the Manchester interface is given in Figure 46.

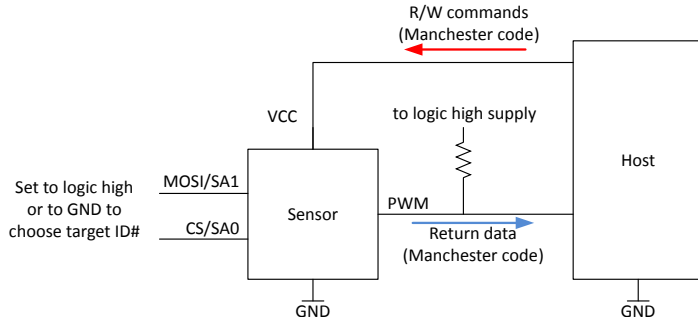

**Figure 46: Manchester Interface Programming Setup**

## CONCEPT OF MANCHESTER COMMUNICATION

The Manchester interface allows programming and readout with a minimal number of pins involved. This is beneficial for sensor subassemblies connected to wiring harnesses, because less connections are needed. The supply level is typically modulated between 5 and 8 volts ( $V_{MAN(H)}$  and  $V_{MAN(L)}$ ) to produce a “low” and “high” signal. In the absence of a clock signal, Manchester encoding is used, allowing the sensor to determine the bit rate that the host is using.

The master can freely choose any supported Manchester communication frequency for each transaction. The sensor will recognize the transaction speed used by the master and send the response at the same data rate.

As Manchester commands are sent on the supply line, the speed is usually limited by capacitances on the supply line. A reduction of the bit rate, or using a stronger line driver, can help to ensure stable communication.

If a correct read command was sent, the sensor responds to the master using the open-drain output on the PWM line. The high level will be determined by the PWM pull-up (usually 3.3 V or 5 V), and the low level will be close to GND. The PWM uses an open drain output, setting the logic levels to GND and logic level high (see Figure 46). A sufficient pull-up resistor (e.g. 4.7 k $\Omega$ ) must be used to pull the line to a maximum logic high level  $V_{IN}$ .

## ENTERING MANCHESTER COMMUNICATION MODE

Provided the Disable Manchester bit is not set in EEPROM, the A1333 continuously monitors the VCC line for valid Manchester commands. The part takes no action until a valid Manchester Access Code is received.

There are two special Manchester code commands used to activate or deactivate the serial interface and specify the output format used during Read operations:

1. Manchester Access Code: Enters Manchester Communication Mode; Manchester code output on the PWM pin. See further paragraphs for example.
2. Manchester Exit Code; returns the PWM pin to normal operation. See further paragraphs for example.

Once the Manchester Communication Mode is entered, the PWM output pin will cease to provide angle data, interrupting any data transmission in progress.

## TRANSACTION TYPES

The A1333 receives all commands via the VCC pin, and responds to Read commands via the PWM pin. This implementation of Manchester encoding requires the communication pulses be within a high ( $V_{MAN(H)}$ ) and low ( $V_{MAN(L)}$ ) range of voltages on the VCC line. Each transaction is initiated by a command from the controller; the sensor does not initiate any transactions. Two commands are recognized by the A1333: Write and Read.

## CONTROLLER MANCHESTER MESSAGE STRUCTURE

The general format of a command message frame is shown in Figure 47. Note that, in the Manchester coding used, a bit value of 1 is indicated by a falling edge within the bit boundary, and a bit value of zero is indicated by a rising edge within the bit boundary.

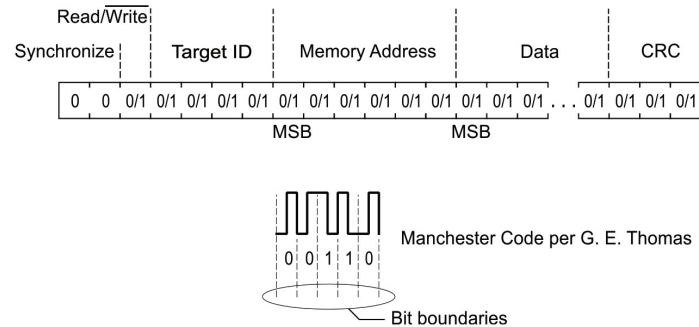

**Figure 47: Manchester Message Format**

A brief description of each bit is provided in Table 5.

**Table 5: Manchester Command General Format**

Bits	Parameter Name	Description
2	Synchronization	Value '00' sent to identify a command start and to synchronise sensor clock
1	Read/Write	0 = write, 1 = read
4	Target ID	Select the target ID for this transaction. [ID3 ID2 ID1 ID0] are each addressed / ignored by a 1 / 0 at their address, so that a write to [0011] will write to ID0 and ID1. Reading from several sensors at the same time is not supported. Writing to [0000] is a broadcast write; it is written to all sensor dies.
6	Address	Serial address for read/write
16	Data	Only for writes: 16 bit write data. Omit for read commands
3	CRC	3-bit CRC, needed for all commands

When the A1333 is operating in PWM mode, the Die ID value is determined by the state of the CSN and MOSI pins, as detailed in Table 6.

**Table 6: Pin Values**

MOSI/SA1	CS/SA0	ID Value
0	0	ID0
0	1	ID1
1	0	ID2
1	1	ID3

Using the 4 bits of the Chip Select field, die can be selected via their ID value, allowing up to four die to be individually addressed and providing for different group addressing schemes.

Example: If Target ID = [1 0 1 0], all die with ID3 or ID1 will be selected. If Target ID is set to [0 0 0 0], then no ID comparison will be made, allowing all sensors to be addressed at once. In case of PWM line sharing for Manchester communication, reading must be done one die at a time.

**Table 7: Target ID**

Target ID			
ID3	ID2	ID1	ID0

### SENSOR MANCHESTER MESSAGE STRUCTURE

If a read command with the desired register number was sent from the controller to the sensor, the device responds with a Read Response frame using the Manchester protocol over the PWM output.

The following command messages can be exchanged between the device and the external controller:

- Manchester Access Code (host to sensor)
- Manchester Exit Code (host to sensor)
- Manchester Write Command (host to sensor)
- Manchester Read Command (host to sensor)
- Manchester Read Response (sensor to host)

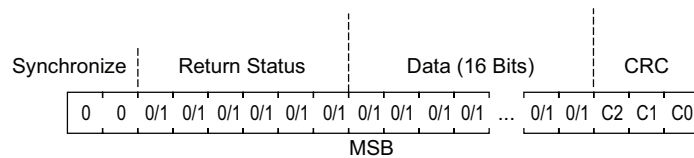

Figure 48: Manchester Message Format

In addition to the contents of the requested memory location, a Return Status field is included with every Read Response. This field provides the ID used to communicate with the part and any errors which may have occurred during the transaction. These bits are:

- **ID** – ID (CSN/MOSI) unless BC = 1 (ID will be 00)
- **BC** – Broadcast; ID field was zero or SPI mode active
- **AE** – Abort Error; edge detection failure after sync detect
- **OR** – Overrun Error; A new Manchester command has been received before the previous request could be completed
- **CS** – Checksum error; a prior command had a checksum error

For EEPROM address information, refer to the EEPROM structure section. For serial address locations, refer to the serial register map.

Table 8: Return Status Bits

Return Status Bits (5 bits)					
5	4	3	2	1	0
ID		BC	AE	OR	CS

### MANCHESTER ACCESS CODE

The Manchester Access Code has to be sent before other Manchester commands.

The Manchester Access Code always operates as a broadcast pulse, meaning the sensor will not look at the Target ID field. For example, if two sensors configured with ID0 and ID1 respectively are sharing a common VCC line, a Manchester Access Code with a Target ID value of [0 0 1 0] results in both sensors entering Manchester Serial Communication mode.

Table 9: Manchester Access Code

Bits	Parameter Name	Description
2	Synchronization	'00'
1	Read/Write	'0'
4	Target ID	'0000' (this command will always be a broadcast, even if it is addressed)
6	Address	'111111' (fixed number for Manchester access message)
16	Data	0x62D2 (fixed number for Manchester access message)
3	CRC	3-bit CRC

An example is given below, with target ID = [0 0 0 1], data = access code = 0x62D2, and CRC = '110'.

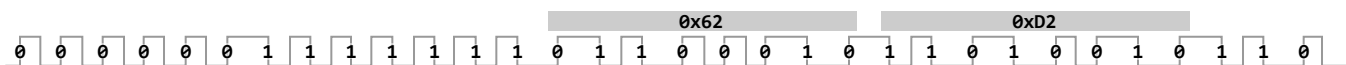

Figure 49: Target ID = [0 0 0 1], Data = Access code = 0x62D2, CRC = '110' 4.3.5.2

### MANCHESTER EXIT CODE

The Manchester Exit Code can be sent after Manchester access is complete in order to avoid accidental decoding of Manchester commands.

The Manchester Exit Code always operates as a broadcast pulse, meaning the sensor will not look at the Target ID field. For example, if two sensors configured with ID0 and ID1 respectively are sharing a common VCC line, a Manchester Access Code with a Target ID value of [0 0 1 0] results in both sensors exiting Manchester Serial Communication mode.

Table 10: Manchester Exit Code

Bits	Parameter Name	Description
2	Synchronization	'00'
1	Read/Write	'0'
4	Target ID	'0000' (this command will always be a broadcast, even if it is addressed)
6	Address	'111111' (fixed number for Manchester exit message)
16	Data	0x0000 (any value except 0x62D2 can be used for Manchester exit message)
3	CRC	3-bit CRC

An example is given below, with target ID = [0 0 0 1], data = 0x0000, and CRC = '110'.

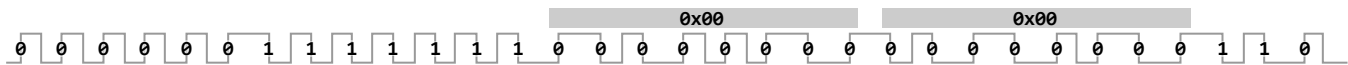

Figure 50: Target ID = [0 0 0 1], Data = 0x0000, CRC = '110'

### MANCHESTER READ COMMAND

Determines the serial address within the sensor from which the next Read Response will transmit data. The sensor must first receive a Manchester Access Code before responding to a read command.

This command is sent by the controller.

An example is given below where register 0x20 "angle" is read from target ID [0 0 0 1] with CRC = '111'. The two sync pulses from the Read Response on the PWM return line are also shown.

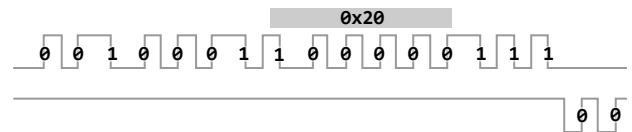

Figure 51: Target ID = [0 0 0 1], "angle" = 0x20, CRC = '111'

Table 11: Manchester Read Command

Bits	Parameter Name	Description
2	Synchronization	'00'
1	Read/Write	'1'
4	Target ID	Depends on targeted sensor ID, e.g. to target ID0, use '0001'
6	Address	Serial Register Address, e.g. 0x10 for "read_data_lo", or 0x20 for "angle"
3	CRC	3-bit CRC

### MANCHESTER READ RESPONSE

The read response transmits data from the sensor to the controller after a read command. These data are sent by the sensor on the open-drain PWM pin. A pull-up resistor is needed for this to work.

Read from an even address returns even byte [15:8] and odd byte [7:0].

Read from an odd address returns odd byte [7:0] only. Data bits [15:8] will be zeroes.

**Table 12: Manchester Read Response**

Bits	Parameter Name	Description
2	Synchronization	'00'
2	ID	Target ID of the responding sensor die. '00' for ID0, '01' for ID1, '10' for ID2, '11' for ID3.
1	BC flag	"Broadcast": Value set to '1' if read command was a broadcast command (Target-ID set to [0 0 0 0]), '0' if not
1	AE flag	"Abort error": Value set to '1' if a previous transaction was aborted and discarded, typically caused by incorrect bit lengths, '0' is there was no problem. The error is stored until it can be transmitted on the next read response, and is cleared afterwards.
1	OR flag	"Overrun error": If a command is sent to the sensor while the sensor is still sending a read response, and this command is completely transmitted before the read response was finished, and overrun error has occurred. This error is then stored until it can be transmitted on the next read response, and is cleared afterwards.
1	CS flag	"CRC error": Value set to '1' if a previous transaction had an incorrect CRC, '0' means there was no problem. The error is stored until it can be transmitted on the next read response, and is cleared afterwards.
16	data	Read from an Even address: even byte [15:8] and odd byte [7:0]. Read from an Odd address: odd byte [7:0] only. Data bits [15:8] will be zeroes.
3	CRC	3-bit CRC

An example is given below where register 0x20 "angle" is read, and the response is ID '00' (ID0), the four flags are all zeros (no errors), the data is "0x5C34", and the CRC is '100'.

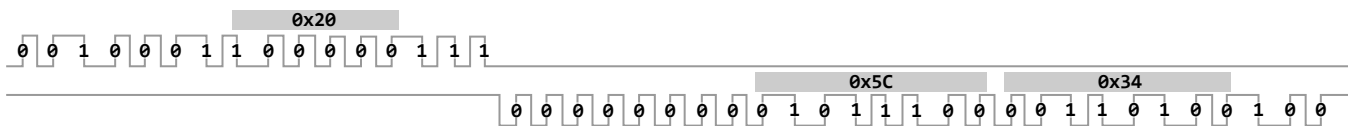

**Figure 52: ID = '00', error flag = '0000', Data = 0x5C34, CRC = '100'**

### MANCHESTER READ RESPONSE DELAY

The Manchester Read Response starts at the end of the Read Command. The response may start a ¼ bit time before the CRC is finished transmitting (overlap with last CRC bit) or ¼ after the CRC finished transmitting.



## CRC

The serial Manchester interface uses a cyclic redundancy check (CRC) for data-bit error checking of all the bits coming after the two synchronization bits. The synchronization bits are not included in the CRC. The CRC algorithm is based on the polynomial:

$$g(x) = x^3 + x + 1.$$

The calculation is represented graphically in Figure 53. The trailing 3 bits of a message frame comprise the CRC token. The CRC is initialized at 111. Data are fed into the CRC logic with MSB first. Output is sent as C2-C1-C0.

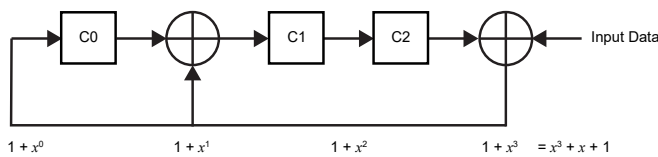

**Figure 53: Manchester CRC Calculation**

The 3-bit Manchester CRC can be calculated using the following C code:

```
// command: the manchester command, right justified, does
// not include the space for the CRC
// numberOfBits: number of bits in the command not includ-
// ing the 2 zero sync bits at the start of the command and the
// three CRC bits
// Returns: The three bit CRC
// This code can be tested at http://codepad.org/yqTKnfmD

uint16_t ManchesterCRC(uint64_t data, uint16_t numberOfBits)
{
    bool C0 = false;
    bool C1 = false;
    bool C2 = false;
    bool C0p = true;
    bool C1p = true;
    bool C2p = true;
    uint64_t bitMask = 1;

    bitMask <<= numberOfBits - 1;

    // Calculate the state machine
    for (; bitMask != 0; bitMask >>= 1)
    {
        C2 = C1p;
        C0 = C2p ^ ((data & bitMask) != 0);
        C1 = C0 ^ C0p;

        C0p = C0;
        C1p = C1;
        C2p = C2;
    }

    return (C2 ? 4U : 0U) + (C1 ? 2U : 0U) + (C0 ? 1U :
0U);
}
```



## EEPROM AND SHADOW MEMORY USAGE

The device uses EEPROM to permanently store configuration parameters for operation. EEPROM is user-programmable and permanently stores operation parameter values or customer information. The operation parameters are downloaded to shadow (volatile) memory at power-up. Shadow fields are initially loaded from corresponding fields in EEPROM, but can be overwritten, either by performing an extended write to the shadow addresses, or by reprogramming the corresponding EEPROM fields and power cycling the IC. Use of Shadow Memory is substantially faster than accessing EEPROM. In situations where many parameter need to be tested quickly, shadow memory is recommended for trying parameter values before permanently programming them into EEPROM. The shadow memory registers have the same format as the EEPROM and are accessed at extended addresses 0x40 higher than the equivalent EEPROM address. Unused bits in the EEPROM do not exist in the related shadow register, and will return 0 when read. Shadow registers do not contain the ECC bits. Shadow registers have the same protection restrictions as the EEPROM. All registers can be read without unlocking. The mapping of bits from registers addresses in EEPROM to their corresponding register addresses in SHADOW is shown in the EEPROM table (See “EEPROM table” section).

### Enabling EEPROM Access

To enable EEPROM write access after power-on-reset, a unlock code needs to be written to the serial register “keycode”. This involves five write commands, which should be executed after each other:

Write 0x00 to register 0x3C[15:8]

Write 0x27 to register 0x3C[15:8]

Write 0x81 to register 0x3C[15:8]

Write 0x1F to register 0x3C[15:8]

Write 0x77 to register 0x3C[15:8]

This needs to be done once after power-on reset if the customer intends to write to the EEPROM.

Writing to serial registers and reading from serial registers does not require anything special after power-on.

Reading all EEPROM cells is always possible.

Device must be unlocked when performing EEPROM margin checking.

### EEPROM Write Lock

It is possible to protect the EEPROM against accidental writes.

- Setting the EEPROM field “lock” to value 0xC (‘1100’ binary) will block any writes to the EEPROM, so that permanent changes are not possible anymore. Temporary changes to the setting are still possible by writing to the shadow memory, but these changes are lost after a power cycle. This lock is permanent and cannot be reversed. Reading of the settings is still possible.
- Setting the EEPROM field “lock” to value 0x3 (‘0011’ binary) will lock EEPROM writes AND shadow memory writes. This means none of the sensor settings can be changed anymore. This lock is permanent and cannot be reversed. Reading of the settings is still possible.

### Write Transaction to EEPROM and Other Extended Locations

Invoking an extended write access is a three-step process:

- Write the extended address into the “ewa” register (using SPI or Manchester direct access). “ewa” is the 8-bit extended address that determines which extended memory address will be accessed.
- Write the data that is to be transferred into the “ewd” registers (using SPI or Manchester direct access). This will take four SPI writes or 2 Manchester packets to load all 32 bits of data.
- Invoke the extended access by writing the direct “ewcs.exw” bit with ‘1’.

The 32-bit of data in “ewd” are then written to the address specified in “ewa”.

The bit “ewcs.wdn” can be polled to determine when the write completes. This is only necessary for EEPROM writes, which can take up to 24 ms to complete. Shadow register writes complete immediately in one system clock cycle after synchronization.

For example, to write location 0x1F in the EEPROM with 0x00A45678:

- Write 0x1F to lower 8 bits of EWA register (0x1F to EWA+1 Address 0x03)

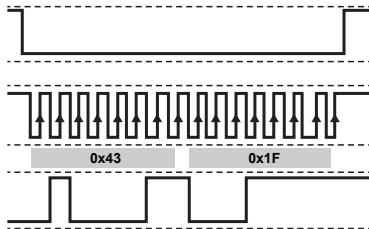

- Write 0x00A45678 to EWD (0x00 to EWD, 0xA4 to EWD+1, 0x56 to EWD+2, 0x78 to EWD+3)

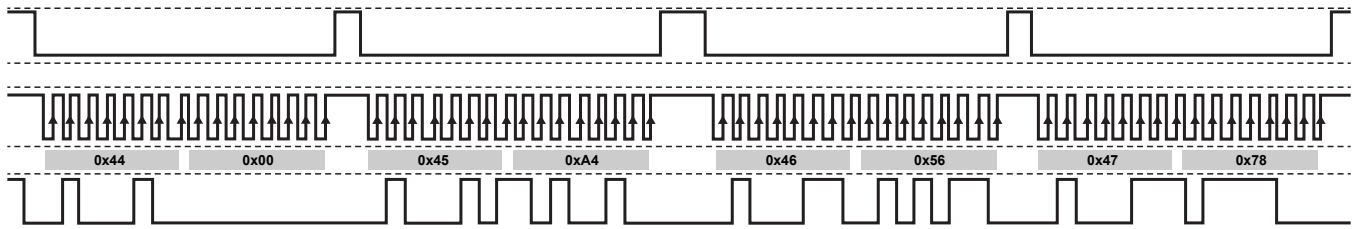

- Write 0x80 to EWCS

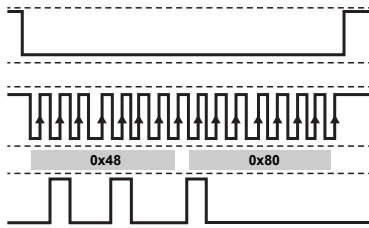

- Read EWCS+1 until bit 0 (“wdn”) is set, or wait enough time.

In the example, register 0x08 is read, so that the second output byte is from register 0x09, and we wait for bit 0 to become ‘1’, which happens in the last read.

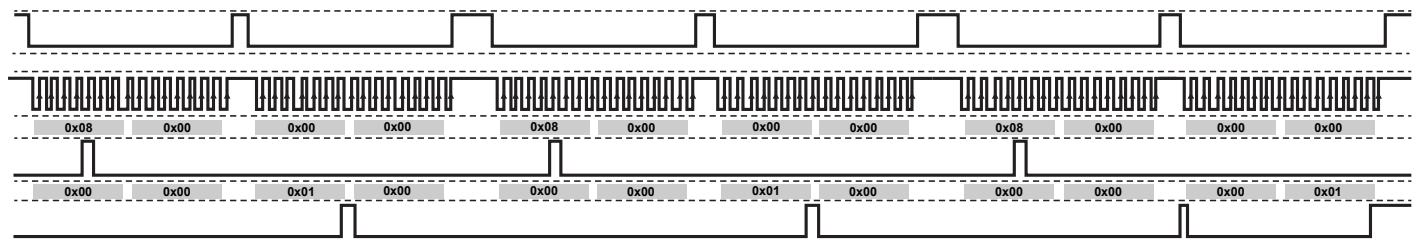

If an access violation occurs (address not unlocked), the transaction will be terminated and the corresponding “rdn” or “wdn” bit set, and the “xee” warning bit will assert. The “xee” bit in the “err” register will also set if the EEPROM write aborts.

After writing to the EEPROM, verify that the write was successful by performing an EEPROM margin check.

### EEPROM Margin Check

Due to nonidealities in transistors, current will slowly leak into or out of EEPROM cells and can, over time, cause small changes in the stored voltage level. Variances in voltage levels of the charge pump can result in a variety of stored EEPROM cell voltages when programming. If this value is marginally close to the threshold, the small drift over lifetime can cause this value to move across the threshold. This results in a corrupted EEPROM value. Since this drift happens slowly over time, if there is an issue, it may not appear for years. For this reason, it is important to perform margin testing (margining) to verify the internal voltage levels of EEPROM cells after programming, and ensure there will be no issue in the future.

Margining is performed by Allegro on all registers at final test. Since EEPROM cell voltages are only modified when writing to the cell, it is not necessary to perform margining on registers that have not been modified.

Margining is performed in two steps: the first checks the validity of the voltage stored on digital '1' cells, and the second checks the voltage stored on digital '0' cells. It is important to perform both steps to ensure there are no issues.

In order to perform margining, a value of '0b0001' must be written to the SPECIAL field of the CTRL register. This reduces the internal threshold value. Once this value is written, an EEPROM read will use this lower threshold when reading EEPROM values. Perform a read on all EEPROM registers that are being tested, and confirm they read correctly. If a stored voltage is marginal to the normal operating threshold, it will appear as a '1' when it should be a '0'.

Repeat this test with the value of '0b0010' in the SPECIAL register to raise the threshold value above normal operation. Again, read all EEPROM registers being tested. In this test, any stored high voltage that is marginal to the normal threshold will appear as a '0' when they should be '1'.

If during either test, a bit is read incorrectly, simply perform another EEPROM write of the desired values to the register, and retest the margins.

Unlike other values in the SPECIAL field, these values will persist and can be read to confirm the write was successful. As a result, the SPECIAL register must be cleared (or power cycled) to return the threshold value to its normal level.

In the figure below,  $V_{NOM(H)}$  represents the nominal voltage programmed into EEPROM cells containing a '1', and  $V_{NOM(L)}$  represents the nominal voltage programmed into EEPROM cells containing a '0'. The red and blue lines represent the actual voltage levels in the programmed cells for '1' and '0' values respectively. As can be seen, at time 0 when the margin test is run, both high and low levels still appear to be the correct value when the threshold is moved to the margin testing levels.

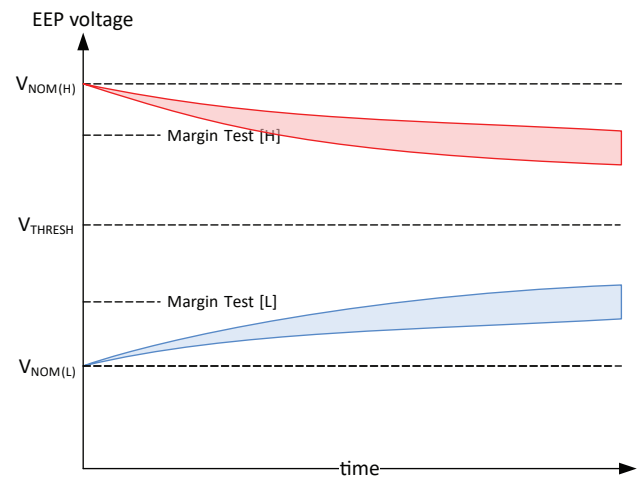

**Figure 54: Example of passing programming voltages**

In the figure below, the high and low voltage levels at the time of programming are further from their target. The drift over time results in these values crossing  $V_{THRESH}$ , and becoming corrupted. At time 0 when the margin test is run, these values fail, and would be reported as errors to be reprogrammed.

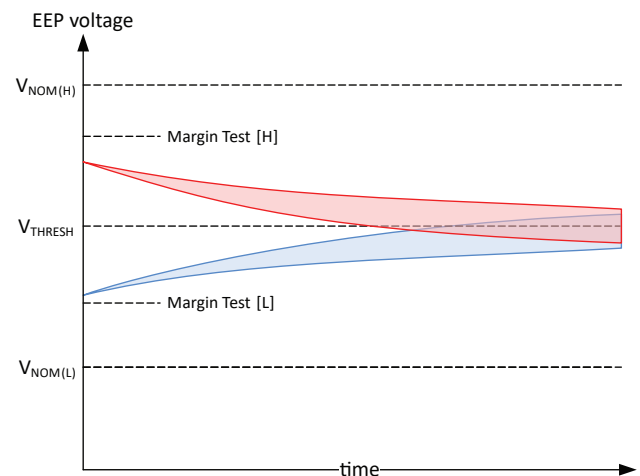

**Figure 55: Example of failing programming voltages**

Margining is shown below as a list of high level steps. For details on performing individual steps, see the associated sections.

1. Clear the ERR and WARN registers.
2. Write new data to EEPROM as desired.
3. Check the following flags for communication errors: ESE, EUE, XEE, IER, CRC, BSY.
4. Set CTRL.special to '0001' and confirm by writing 0xA5 to CTRL.initiate\_special.
5. Check the following flags for communication errors: ESE, EUE, XEE, IER, CRC, BSY.
6. Read all EEPROM registers changed in step 1 and verify their contents.
7. Set CTRL.special to '0010' and confirm by writing 0xA5 to CTRL.initiate\_special.
8. Check the following flags for communication errors: ESE, EUE, XEE, IER, CRC, BSY.
9. Read all EEPROM registers changed in step 1 and verify their contents.
10. If any values read in steps 3/5 are not what was set in step 1, repeat steps 1-6 for erroneous registers.
11. Set CTRL.special to '0000', or power cycle the part.

### Read Transaction from EEPROM and Other Extended Locations

Extended access is provided to additional memory space via the direct registers. This access includes the EEPROM and EEPROM shadow registers. All extended registers are up to 32 bits wide. Invoking an extended read access is a three-step process:

1. Write the extended address to be read into the “era” register (using SPI or Manchester direct access). “era” is the 8-bit extended address that determines which extended memory address will be accessed.
2. Invoke the extended access by writing the direct “ercs.ext” bit with ‘1’. The address specified in “era” is then read, and the data is loaded into the “erd” registers.
3. Read the “erd” registers (using SPI or Manchester direct access) to get the extended data. This will take multiple packets to get all 32 bits.

EEPROM read accesses may take up to 2  $\mu$ s to complete. The “ercs.rdn” bit can be polled to determine if the read access is complete before reading the data. Shadow register reads complete in one system clock cycle after synchronization. Do not attempt to read the “erd” registers if the read access is potentially in process, as it could change during the serial access and the data will be inconsistent. It is also possible that an SPI CRC error will be detected if the data changes during the serial read via the SPI interface.

For example, to read location 0x1F in the EEPROM:

- Write 0x1F to lower 8 bits of “era” (0x1F to “era+1”, Address 0x0B)

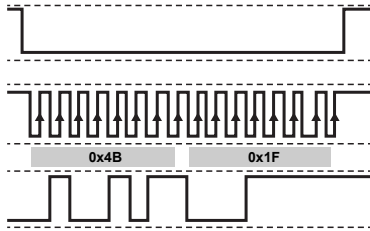

- Write 0x80 to “ercs”

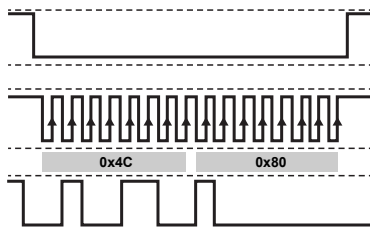

- Read “ercs”+1 until bit 0 (“rdn”) is set, or wait enough time. In the example, register 0x0C is read, so that the last bit of the second output byte contains the “rdn” bit.

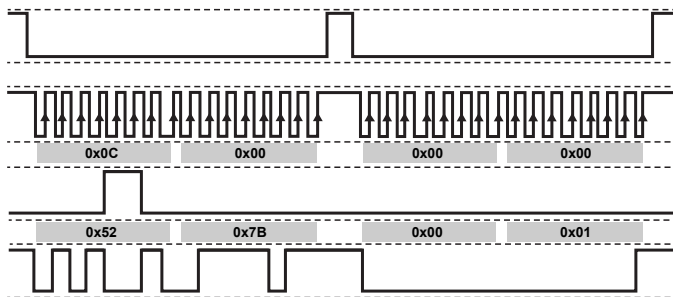

- Read “erdh” (upper 16 bits of read data)
- Read “erdl” (lower 16 bits of read data)

In the example below, the result for the data at address 0x1F is 0x58A45678. In this value,

- Bit [31:26] are the EEPROM CRC
- Bit [25:24] are unused and zero
- Bit [23:0] are the EEPROM values that can be used. These are the 24 bits containing the information 0xA45678 that was written in the EEPROM write example.

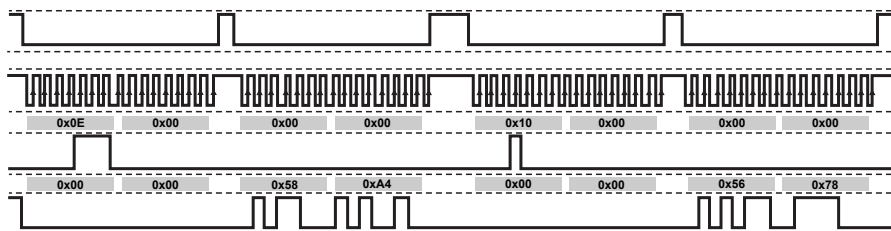

Note that it would have been possible to pipeline transactions in this example, i.e. send a new command while reading return data from the old command. This way the transaction could have been performed in 5 SPI frames instead of 8.

**Shadow Memory Read and Write Transactions**

Shadow memory Read and Write transactions are identical to those for EEPROM. Instead of addressing to the EEPROM extended address, one must address to the Shadow Extended addresses, which are located at an offset of 0x40 above the EEPROM. Refer to the EEPROM table for all addresses.

### PRIMARY SERIAL INTERFACE REGISTER REFERENCE

Table 13: Primary Serial Interface Registers Bits Map

Address* (0x00)	Register Symbol	Read/ Write	Addressed Byte (MSB)								Addressed Byte + 1 (LSB)								LSB Address	
			15	14	13	12	11	10	9	8	7	6	5	4	3	2	1	0		
0x00	nop	RO	0	0	0	0	0	0	0	0	0	0	0	0	0	0	0	0	0x01	
0x02	ewa	RW	0	0	0	0	0	0	0	0	write_adr								0x03	
0x04	ewdh	RW	write_data_hi																0x05	
0x06	ewdl	RW	write_data_lo																0x07	
0x08	ewcs	WO/RO	exw	0	0	0	0	0	0	0	wip	0	0	0	0	0	0	0	0	0x09
0x0A	era	RW	0	0	0	0	0	0	0	0	read_adr								0x0B	
0x0C	ercs	WO/RO	exr	0	0	0	0	0	0	0	rip	0	0	0	0	0	0	0	rdn	0x0D
0x0E	erdh	RO	read_data_hi																0x0F	
0x10	erdl	RO	read_data_lo																0x11	
0x12 0x14 0x16 0x18 0x1A 0x1C	Unused	RO	0	0	0	0	0	0	0	0	0	0	0	0	0	0	0	0	0	0x13 0x15 0x17 0x19 0x1B 0x1D
0x1E	ctrl	RW/WO	special				0	cls	clw	cle	initiate_special								0x1F	
0x20	ang	RO	0	ef	uv	p	angle											0x21		
0x22	sta	RO	1	0	0	0	0	0	dieid	rot	0	sdn	bdn	lbr	cstr	bip	aok	0x23		
0x24	err	RO	1	0	1	0	war	stf	avg	abi	plk	zie	eue	ofe	uvd	uva	msl	rst	0x25	
0x26	warn	RO	1	0	1	1	ier	crc	0	srw	xee	tr	ese	sat	tcw	bsy	msh	tov	0x27	
0x28	tsen	RO	1	1	1	1	temperature											0x29		
0x2A	field	RO	1	1	1	0	gauss											0x2B		
0x2C	turns	RO	1	1	0	p	turns											0x2D		
0x2E	Unused	RO	0	0	0	0	0	0	0	0	0	0	0	0	0	0	0	0	0x2F	
0x30	hang	RO	0	ef	uv	p	angle_hys											0x31		
0x32	ang15	RO	0	angle_15														0x33		
0x34	zang	RO	0	ef	uv	p	angle_zcd											0x35		
0x36 0x38 0x3A	Unused	RO	0	0	0	0	0	0	0	0	0	0	0	0	0	0	0	0	0x37 0x39 0x3B	
0x3C	key	WO/RO	keycode								0	0	0	0	0	0	0	cul	0x3D	
0x3E	Unused	RO	0	0	0	0	0	0	0	0	0	0	0	0	0	0	0	0	0x3F	

\*Addresses that span multiple bytes are addressed by the most significant byte.

#### Address 0x00:0x00 (NOP) – Null Register

Address	0x00								0x01							
Bit	15	14	13	12	11	10	9	8	7	6	5	4	3	2	1	0
Name	0	0	0	0	0	0	0	0	0	0	0	0	0	0	0	0
R/W	R	R	R	R	R	R	R	R	R	R	R	R	R	R	R	R



### Address 0x02:0x03 (EWA) – Extended Write Address

Address	0x02								0x03							
Bit	15	14	13	12	11	10	9	8	7	6	5	4	3	2	1	0
Name	0	0	0	0	0	0	0	0	WRITE_ADDR							
R/W	R	R	R	R	R	R	R	R	R/W	R/W	R/W	R/W	R/W	R/W	R/W	R/W

#### WRITE\_ADDR[7:0]:

Address to be used for an extended write. Address ranges:  
 0x00 - 0x1F: EEPROM (requires ≈ 24 ms following execution of a write)  
 0x40 - 0x5F: Shadow

### Address 0x04:0x05 (EWDH) – Extended Write Data High

Address	0x04								0x05							
Bit	15	14	13	12	11	10	9	8	7	6	5	4	3	2	1	0
Name	WRITE_DATA_HI															
R/W	R/W	R/W	R/W	R/W	R/W	R/W	R/W	R/W	R/W	R/W	R/W	R/W	R/W	R/W	R/W	R/W

#### WRITE\_DATA\_HI[15:0]:

Upper 16 bits of data for an extended write operation.

### Address 0x06:0x07 (EWDL) – Extended Write Data Low

Address	0x06								0x07							
Bit	15	14	13	12	11	10	9	8	7	6	5	4	3	2	1	0
Name	WRITE_DATA_LO															
R/W	R/W	R/W	R/W	R/W	R/W	R/W	R/W	R/W	R/W	R/W	R/W	R/W	R/W	R/W	R/W	R/W

#### WRITE\_DATA\_LO[15:0]:

Lower 16 bits of data for an extended write operation.

### Address 0x08:0x09 (EWCS) – Extended Write Control and Status

Address	0x08								0x09							
Bit	15	14	13	12	11	10	9	8	7	6	5	4	3	2	1	0
Name	EXW	0	0	0	0	0	0	WIP	0	0	0	0	0	0	0	WDN
R/W	W	R	R	R	R	R	R	R	R	R	R	R	R	R	R	R

#### EXW[15]:

Initiate extended write by writing with '1'. Sets WIP, clears WDN. Write-only, always reads back 0.

#### WIP[8]:

Write in progress when '1'.

#### RDN[0]:

Write done when '1', clears when EXR set to '1'.

### Address 0x0A:0x0B (ERA) – Extended Read Address

Address	0x0A								0x0B							
Bit	15	14	13	12	11	10	9	8	7	6	5	4	3	2	1	0
Name	0	0	0	0	0	0	0	0	READ_ADDR							
R/W	R	R	R	R	R	R	R	R	R/W	R/W	R/W	R/W	R/W	R/W	R/W	R/W

#### READ\_ADDR[7:0]:

Address to be used for an extended read. Address ranges:

0x00 - 0x1F: EEPROM (requires ≈2 μs)

0x40 - 0x5F: Shadow

### Address 0x0C:0x0D (ERCS) – Extended Read Control and Status

Address	0x0C								0x0D							
Bit	15	14	13	12	11	10	9	8	7	6	5	4	3	2	1	0
Name	EXR	0	0	0	0	0	0	RIP	0	0	0	0	0	0	0	RDN
R/W	W	R	R	R	R	R	R	R	R	R	R	R	R	R	R	R

#### EXR[15]:

Initiate extended read by writing with '1'. Sets RIP, clears RDN. Write-only, always reads back 0.

#### RDN[0]:

Read done when '1', clears when EXR set to '1'.

#### RIP[8]:

Read in progress when '1'.

### Address 0x0E:0x0F (ERDH) – Extended Read Data High

Address	0x0E								0x0F							
Bit	15	14	13	12	11	10	9	8	7	6	5	4	3	2	1	0
Name	READ_DATA_HI															
R/W	R	R	R	R	R	R	R	R	R	R	R	R	R	R	R	R

#### READ\_DATA\_HI[15:0]:

Upper 16 bits of data from extended read operation, valid when ERCS.

RDN set to '1'.

### Address 0x10:0x11 (ERDL) – Extended Read Data Low

Address	0x10								0x11							
Bit	15	14	13	12	11	10	9	8	7	6	5	4	3	2	1	0
Name	READ_DATA_LO															
R/W	R	R	R	R	R	R	R	R	R	R	R	R	R	R	R	R

#### READ\_DATA\_LO[15:0]:

Lower 16 bits of data from extended read operation, valid when ERCS.

RDN set to '1'.

### Address 0x1E:0x1F (CTRL) – Device Control

Address	0x1E								0x1F							
Bit	15	14	13	12	11	10	9	8	7	6	5	4	3	2	1	0
Name	SPECIAL				0	CLS	CLW	CLE	INITIATE_SPECIAL							
R/W	R/W	R/W	R/W	R/W	R	R/W	W	W	W	W	W	W	W	W	W	W

#### SPECIAL[15:12]:

Defines specific actions to be taken by the IC. Many actions will only be invoked after the CTRL.INITIATE\_SPECIAL field is written with the correct value. Aside from EEPROM margining, this field will return 0x00 on completion.

Value	Description
0000	No action.
0001	Enable EEPROM low voltage margin. IC must be unlocked. Initiate with 0xA5.
0010	Enable EEPROM high voltage margin. IC must be unlocked. Initiate with 0xA5.
0100	Turns counter reset. Initiate with 0x46.
0101	Reload EEPROM. Requires IC to be unlocked. Initiate with 0xA5.
0110	No action.
0111	Hard reset. Requires unlock of part. Initiate with 0xA5.
1001	Run CVH self-test. Initiate with 0xB9.
1010	Run Logic BIST. Initiate with 0xB9.
1011	Run both CVH self-test and Logic BIST. Tests are run in parallel. Initiate with 0xB9.

#### CLS[10]:

Clear Status register bits “SDN” and “BDN”, when set to “1”.

STA.SDN indicates that a “special access” task (i.e. CVH self-test) is completed.

STA.BDN indicates the IC has booted properly and completed any start-up self-tests.

#### CLW[9]:

Clear warning (WARN) register when set to “1”.

Clears bits that were previously read from the WARN (register 0x26:0x27). Write-only, always returns 0.

#### CLE[8]:

Clear error (ERR) register when set to “1”.

Clears bits that were previously read from the ERR (register 0x24:25). Write-only, always returns 0.

#### INITIATE\_SPECIAL[7:0]:

Write after setting certain CTRL.SPECIAL bits to initiate the selected action(s).

Always returns 0's.

Value	Description
0xB9	Initiate self-tests.
0x46	Initiate turns counter reset.
0x5A	Initiate hard reset.

### Address 0x20:0x21 (ANG) – Current Angle Reading (12 bits)

Address	0x20								0x21							
Bit	15	14	13	12	11	10	9	8	7	6	5	4	3	2	1	0
Name	0	EF	UV	P	ANGLE											
R/W	R	R	R	R	R	R	R	R	R	R	R	R	R	R	R	R

#### EF[14]:

Error Flag. Will be “1” if any unmasked bit in ERR or WARN is set.

Value	Description
0	No unmasked errors
1	Unmasked error is present

#### UV[13]:

Undervoltage Flag (real time). Logical OR of analog and digital UV flags (UVD and UVA flags). Conditions are realtime, but may be masked by EEPROM error mask bits.

Value	Description
0	No undervoltage condition detected
1	Undervoltage condition detected

#### P[12]:

Parity bit. Odd parity is calculated across all bits (EF, UV, ANGLE). Result is that there should always be an odd number of 1’s in this 16 bit word.

#### ANGLE[11:0]:

Angle from PLL after processing.  
Angle in degrees is 12-bit value × (360/4096).

### Address 0x22:0x23 (STA) – Device Status

Address	0x22								0x23							
Bit	15	14	13	12	11	10	9	8	7	6	5	4	3	2	1	0
Name	1	0	0	0	0	0	DIE_ID		ROT	0	SDN	BDN	LBR	CSTR	BIP	AOK
R/W	R	R	R	R	R	R	R	R	R	R	R	R	R	R	R	R

#### RIDC[15:12]:

Register ID bits. Used to distinguish this registers from other serial registers. Hard-coded value.

Value	Description
1000	Register ID value

#### DIE\_ID[9:8]:

DIE ID, loaded from EEPROM (for multi-die packages). Used for identification purposes only. No impact on sensor functionality. Set in factory by Allegro.

#### ROT[7]:

Indicates observed rotation direction, based on the hysteresis logic. Valid only if Hysteresis is enabled (see EEPROM 0x1C).

Value	Description
0	Increasing angles
1	Decreasing angles

#### SDN[5]:

Special access (from CTRL register) done. Clears to 0 when a “special command” is triggered, set 1 when complete. Can clear with CTRL.CLS bit = 1.

Value	Description
0	“Special” command in progress, unless cleared previously
1	“Special” command completed

#### BDN[4]:

Boot complete. EEPROM loaded and any startup self-tests are complete. Can clear with CTRL.CLS bit = 1.

Value	Description
0	Boot not complete, unless cleared previously.
1	Boot complete

#### LBR[3]:

Logic BIST (LBIST) running.

Value	Description
0	LBIST not running
1	LBIST running

#### CSTR[2]:

CVH Self-test running.

Value	Description
0	CVH self-test not running
1	CVH self-test running

#### BIP[1]:

Boot in progress. Output values may not be valid.

Value	Description
0	Boot not in progress
1	Sensor is undergoing its boot sequence

#### AOK[0]:

Angle output is OK. Indicates the PLL is locked and stat-up sequence has completed.

Value	Description
0	Angle is not valid
1	PLL is locked, angle value is valid

### Address 0x24:0x25 (ERR) – Device Error Flags

This is the error register. All errors are latched, meaning they will remain high after they occurred. Errors need to be read and then cleared in order to remove them. It is important that the user clears errors so that subsequent errors become visible. This is especially important for the “RST” error flag (reset), which is always enabled after power on. Not removing it means that an unexpected reset cannot be discovered afterwards.

Address	0x24								0x25							
Bit	15	14	13	12	11	10	9	8	7	6	5	4	3	2	1	0
Name	1	0	1	0	WAR	STF	AVG	ABI	PLK	ZIE	EUE	OFE	UVD	UVA	MSL	RST
R/W	R	R	R	R	R	R	R	R	R	R	R	R	R	R	R	R

#### RIDC[15:12]:

Register ID bits. Used to distinguish this registers from other serial registers. Hard-coded value.

Value	Description
1010	Register ID value

#### WAR[11]:

Warning. An unmasked bit within the WARN register is asserted. May be masked by setting MSK.WAR bit in EEPROM.

Value	Description
0	No unmasked flag set in the WARN register (0x26:27)
1	Unmasked flag set in the WARN register

#### STF[10]:

Self-test failure. Indicates either LBIST or CVH self-test failed.

Value	Description
0	No self-test failure
1	Self-test failure

#### AVG[9]:

Angle averaging error. Indicates the ORATE value is too high for the rotation velocity, and the averaged angle value is corrupted. The ORATE setting allows multiple angle values to be averaged together, for improved precision. This reduces the response time of the sensor, and can result in corrupted angle values is the velocity is too high.

Value	Description
0	No Averaging error
1	Averaging error

#### ABI[8]:

ABI integrity fault. The quadrature integrity of the ABI could not be maintained.

Value	Description
0	No ABI integrity fault
1	ABI integrity fault

#### PLK[7]:

PLL lost lock. This indicates the PLL is not tracking the incoming angle properly. Angle value is corrupt.

Value	Description
0	No PLL lock.
1	PLL lost lock. Angle value invalid.

#### ZIE[6]:

Zero crossing integrity error—a zero crossing did not occur within the maximum time expected, likely indicating missing magnet, or extreme rotation.

Value	Description
0	No Zero crossing error
1	Zero crossing error

#### EUE[5]:

EEPROM uncorrectable error. A multi-bit EEPROM read occurred. EEPROM bit errors are only checked on EEPROM load (i.e. power-up or reset).

Value	Description
0	No multi-bit EEPROM error
1	Multi-bit EEPROM error

#### OFE[4]:

Oscillator Frequency Error. One of the oscillator watchdogs circuits, monitoring the high frequency and low frequency oscillators has tripped.

Value	Description
0	No oscillator error
1	Oscillator watchdog error

#### UVD[3]:

VCC Undervoltage detector tripped. Will continue to set until fault goes away (and ERR register is cleared). This is the VCC input pin voltage.

Value	Description
0	No VCC voltage error
1	VCC undervoltage error detected

### UVA[2]:

Undervoltage detector tripped. Will continue to set until fault goes away (and ERR register is cleared). This is the analog regulator output.

Value	Description
0	No voltage error
1	Voltage error on the analog regulator output

### RST[0]:

Reset condition. Sets on power-on reset or hard reset. Does not set on LBIST. Indicates volatile registers have been re-initialized.

Value	Description
0	No reset
1	Device has been reset. Volatile registers are re-initialized.

### MSL[1]:

Magnetic sense low fault. Magnetic sense was below the low limit threshold.

Low limit threshold is set via the COM.MAG\_THRES\_LO field in EEPROM.

By default this is set to  $\approx 200$  G.

Value	Description
0	No magnetic field low fault
1	Magnetic field lower than threshold

### Address 0x26:0x27 (WARN) – Device Warning Flags

This is the warning register. All warnings are latched, meaning they will remain high after they occurred. Warnings need to be read and then cleared in order to remove them. Warnings indicate either communication type conditions or conditions that may result in a degradation of the angle accuracy, but are less likely than errors to indicate a corruption of the angle.

Address	0x26								0x27							
Bit	15	14	13	12	11	10	9	8	7	6	5	4	3	2	1	0
Name	1	0	1	1	IER	CRC	0	SRW	XEE	TR	ESE	SAT	TCW	BSY	MSH	TOV
R/W	R	R	R	R	R	R	R	R	R	R	R	R	R	R	R	R

#### RIDC[15:12]:

Register ID bits. Used to distinguish this registers from other serial registers. Hard-coded value.

Value	Description
1011	Register ID value

#### IER[11]:

Interface error. Invalid number of bits in SPI packet, or bit 15 of MOSI data = '1'. Packet was discarded. Also indicates a Manchester error.

Value	Description
0	No Interface Error
1	Interface Error

#### CRC[10]:

Incoming SPI CRC error. Packet was discarded. Incoming CRC is only checked if the PWI.SC bit in EEPROM is set.

Value	Description
0	No incoming SPI CRC error
1	Incoming SPI CRC is bad

#### SRW[8]:

Slew rate warning. This warning is asserted if the ABI slew rate limiting is enabled and a condition that requires the limiting to be applied has occurred.

Purpose of Slew Rate Limiting is to prevent an ABI integrity error.

Value	Description
0	Slew rate limiting is not active.
1	Slew rate limiting is active. ABI output is incrementing at the designated slew rate.

#### XEE[7]:

Extended execute error. A command initiated by an extended write failed. Write failed due to access error (not unlocked) or EEPROM write failure.

Value	Description
0	No incoming extended error
1	Extended execute Error

#### TR[6]:

Temperature out of range. The temperature sensor calculated a temperature below  $-60^{\circ}\text{C}$  or above  $180^{\circ}\text{C}$ . Temperature will saturate at those limits.

Value	Description
0	Temperature sensor in range
1	Sensed temperature is below $-60^{\circ}$ or above $180^{\circ}\text{C}$

#### ESE[5]:

EEPROM soft error. A correctable (single-bit) EEPROM read occurred. EEPROM bit errors are only checked on EEPROM load (power-on or reset).

Value	Description
0	No single bit EEPROM error
1	EEPROM single bit error detected and corrected

#### SAT[4]:

Aggregate saturation flag. Shows that any internal signals have saturated, likely to have been cause by extremely strong or weak fields.

Value	Description
0	No saturation detected within the signal chain.
1	Saturation conditions detected within the signal chain.



### TCW[3]:

Turns counter warning. Over 135° of angle change between turns count updates. Indicates an unexpectedly large angle step between ZCD angle readings. Most likely cause is a loss of valid magnetic signal (i.e. magnet absent). Check measured field strength (register 0x2A).

Value	Description
0	No turns count warning
1	Angle difference between two successive ZCD samples is > 135°

### BSY[2]:

Extended access overflow. An Extended write or Extended read was initiated before previous was done.

Value	Description
0	No extended access error
1	extended access error

### MSH[1]:

Magnetic sense high fault. Magnetic sense was above the high limit threshold.

High limit threshold is set via the COM.MAG\_THRES\_HI field in EEPROM.

By default this is set to ≈1200 G.

Value	Description
0	No magnetic field high fault
1	Magnetic field above threshold

### TOV[0]:

Turns Counter Overflow Error.

The turns counter surpassed its maximum value of +255/-256 full rotations.

This is equivalent to an Turns register value of ±511/-512 or +2047/-2048, depending on the resolution (180° or 45°).

Must be cleared with a turns count reset (See special commands in the CTRL register description, 0x1E).

Value	Description
0	No turns count overflow error
1	Turns count overflow error

### Address 0x28:0x29 (TSEN) – Temperature Sensor

Address	0x28								0x29							
	15	14	13	12	11	10	9	8	7	6	5	4	3	2	1	0
Name	1	1	1	1	TEMPERATURE											
R/W	R	R	R	R	R	R	R	R	R	R	R	R	R	R	R	R

### RIDC[15:12]:

Register ID bits. Used to distinguish this registers from other serial registers. Hard-coded value.

Value	Description
1111	Register ID value

### TEMPERATURE[11:0]:

Current junction temperature from internal temperature sensor relative to room temperature (signed value, 2's complement). Value is in 1/8 of a degree. Temperature °C ≈ (TSEN.TEMPERATURE / 8) + 25.0.

### Address 0x2A:0x2B (FIELD) – Field Strength (in gauss)

Address	0x2A								0x2B							
Bit	15	14	13	12	11	10	9	8	7	6	5	4	3	2	1	0
Name	1	1	1	0	GAUSS											
R/W	R	R	R	R	R	R	R	R	R	R	R	R	R	R	R	R

#### RIDC[15:12]:

Register ID bits. Used to distinguish this registers from other serial registers. Hard-coded value.

Value	Description
1110	Register ID value

#### GAUSS [11:0]:

Measured field strength in gauss. Updated every 128  $\mu$ s. Field reading is used for signal path adjustments internal to the IC, and provided for convenient comparison of field readings over magnetic air gap. No guarantee of accuracy is made.

In general, the A1333 field reading is  $\approx$ 11% below actual gauss levels.

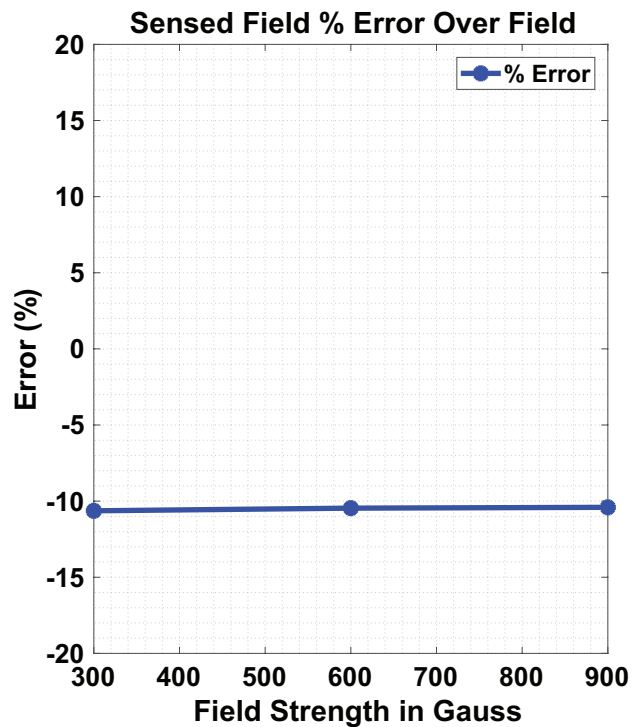
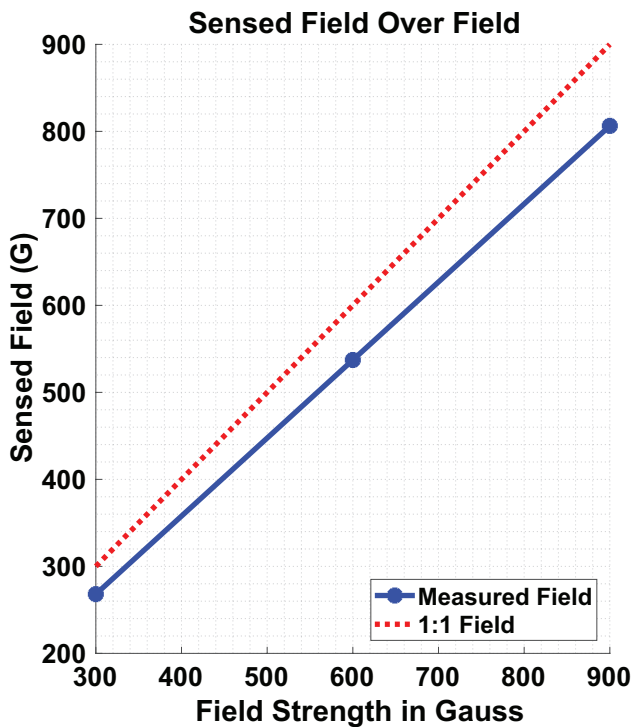

### Address 0x2C:0x2D (TURNS) – Turns Counter

Address	0x0C								0x0D							
Bit	15	14	13	12	11	10	9	8	7	6	5	4	3	2	1	0
Name	1	1	0	P	TURNS											
R/W	R	R	R	R	R	R	R	R	R	R	R	R	R	R	R	R

#### RIDC[15:13]:

Register ID bits. Used to distinguish this registers from other serial registers. Hard-coded value.

Value	Description
110	Register ID value

#### P[12]:

Parity bit. Odd parity is calculated across all bits. Result is that there should always be an odd number of 1's in this 16-bit word.

#### TURNS [11:0]:

Signed 2's complement value. Indicates total number of turns relative to angle observed on power-up. Turns resolution set via EEPROM to either 180° or 45°.

The A1333 is capable of tracking up to 256 full mechanical rotations, independent of the resolution selected.

Bit Value	Turns in 180° mode (Actual mechanical full rotations)	Turns in 45° mode (Actual mechanical full rotations)
0000 0000 0000	0 (0)	0 (0)
0000 0000 0001	+1 (+1/2)	+1 (+1/8)
0001 1111 1111	+511 (255.5)	+511 (+63.875 )
0010 0000 0000	N/A	+512 (+64)
0111 1111 1111	N/A	+2047(+255.875)
1111 1111 1111	-1 (-1/2)	-1 (-1/8th)
1110 0000 0000	-512 (-256)	-512 (-64)
1000 0000 0000	N/A	-2048 (-256)

### Address 0x30:0x31 (HANG) – Hysteresis Angle Value (12 bits)

Address	0x30								0x31							
Bit	15	14	13	12	11	10	9	8	7	6	5	4	3	2	1	0
Name	0	EF	UV	P	ANGLE_HYS											
R/W	R	R	R	R	R	R	R	R	R	R	R	R	R	R	R	R

#### EF[14]:

Error Flag. Will be “1” if any unmasked bit in ERR or WARN is set.

Value	Description
0	No unmasked errors
1	Unmasked error is present

#### UV[13]:

Undervoltage Flag (real time). Logical OR of analog and digital UV flags (UVD and UVA flags). Conditions are realtime, but may be masked by EEPROM error mask bits.

Value	Description
0	No undervoltage condition detected
1	Undervoltage condition detected

#### P[12]:

Parity bit. Odd parity is calculated across all bits (EF, UV, ANGLE\_HYS). Result is that there should always be an odd number of 1’s in this 16 bit word.

#### ANGLE\_HYS[11:0]:

Angle from PLL after hysteresis processing.  
Angle in degrees is 12-bit value × (360/4096).

### Address 0x32:0x33 (ANG15) – Current Angle Reading (15 bits)

Address	0x32								0x33							
Bit	15	14	13	12	11	10	9	8	7	6	5	4	3	2	1	0
Name	0	ANGLE_15														
R/W	R	R	R	R	R	R	R	R	R	R	R	R	R	R	R	R

#### ANGLE\_15[14:0]:

15-bit compensated angle (not rounded).  
Angle in degrees is a 15-bit value × (360/32768)

### Address 0x34:0x35 (ZANG) – ZCD Angle

Angle from the ZCD signal path is used for turns counting. This angle is not compensated over temperature and will not exactly match the PLL angle value.

Address	0x34								0x35							
Bit	15	14	13	12	11	10	9	8	7	6	5	4	3	2	1	0
Name	0	EF	UV	P	ANGLE_ZCD											
R/W	R	R	R	R	R	R	R	R	R	R	R	R	R	R	R	R

#### EF[14]:

Error Flag. Will be “1” if any unmasked bit in ERR or WARN is set.

Value	Description
0	No unmasked errors
1	Unmasked error is present

#### UV[13]:

Undervoltage Flag (real time). Logical OR of analog and digital UV flags (UVD and UVA flags). Conditions are realtime, but may be masked by EEPROM error mask bits.

Value	Description
0	No undervoltage condition detected
1	Undervoltage condition detected

#### P[12]:

Parity bit. Odd parity is calculated across all bits (EF, UV, ANGLE\_ZCD). Result is that there should always be an odd number of 1’s in this 16 bit word.

#### ANGLE\_ZCD[11:0]:

Angle from the ZCD signal path. Not compensated. Angle in degrees is 12-bit value × (360/4096).

### Address 0x3C:0x3D (KEY) – Key Register

Address	0x3C								0x3D							
Bit	15	14	13	12	11	10	9	8	7	6	5	4	3	2	1	0
Name	KEYCODE								0	0	0	0	0	0	0	CUL
R/W	W	W	W	W	W	W	W	W	R	R	R	R	R	R	R	R

#### KEYCODE[15:8]:

Unlock code is entered here. Once unlocked EEPROM and Shadow registers may be written. In addition some “special” commands require a device unlock.

Unlocking requires five successive writes to the KEYCODE field, following the unlock sequence shown below.

The CUL indicates a successful unlock.

Write #	Code
1	0x00
2	0x27
3	0x81
4	0x1F
5	0x77

#### CUL[0]:

Indicates the device is unlocked.

Value	Description
0	Device is not unlocked
1	Device is unlocked

### EEPROM/SHADOW MEMORY TABLE

The EEPROM/Shadow register bitmap is shown below.

All EEPROM and shadow contents can be read by the user, without unlocking. Writing requires device unlock.

**Table 14: EEPROM/Shadow Memory Map**

EEPROM Address	Shadow Memory Address	Register Name	Bits																														
			31:26	25	24	23	22	21	20	19	18	17	16	15	14	13	12	11	10	9	8	7	6	5	4	3	2	1	0				
0x18	0x58	PWE	ECC	-	-	-	-	-	-	-	-	-	-	-	-	-	-	TOV	TR	MSH	SAT	ESE	MSL	UV	AVG	ZIE	PLK	STF	EUE	OFE			
0x19	0x59	ABI	ECC	-	-	-	-	ABI_SLEW_TIME						INV	-X-	-X-	AHE	-	-	INDEX_MODE		WDH	PLH	IOE	UWV	RESOLUTION_PAIRS							
0x1A	0x5A	MSK	ECC	-	-	IER	CRC	-X-	SRW	XEE	TR	ESE	SAT	TCW	BSY	MSH	TOV	WAR	STF	AVG	ABI	PLK	ZIE	EUE	OFE	UVD	UVA	MSL	RST				
0x1B	0x5B	PWI	ECC	-	-	PEN	PWM_BAND			PWM_FREQ				-	PHE	PEO	PES	-	-	-	-	-	-	-	-	-	DM	-	S17	SC			
0x1C	0x5C	ANG	ECC	-	-	ORATE				RD	RO	HYSTERESIS						ZERO_OFFSET															
0x1D	0x5D	LPC	ECC	-	-	T45	-	-	-	-	-	-	-	-	-	-	-	-	-	-	-	-	-	-	-	-	-	-	-	-			
0x1E	0x5E	COM	ECC	-	-	LOCK				LBE	CSE	-	-	-	-	DST	DHR	MAG_THRES_HI					MAG_THRES_LO										
0x1F	-	CUS	ECC	-	-	Customer EEPROM Space																											

#### Address 0x18 (PWE) – PWM Error Enable

This address space contains the PWM error enable bits. When set to “1”, the PWM output will respond to errors, as set via the PWI.PEO and PWI.PES bits.

Bit	23	22	21	20	19	18	17	16	15	14	13	12	11	10	9	8	7	6	5	4	3	2	1	0
Name	-	-	-	-	-	-	-	-	-	-	-	TOV	TR	MSH	SAT	ESE	MSL	UV	AVG	ZIE	PLK	STF	EUE	OFE
Default	-	-	-	-	-	-	-	-	-	-	-	0	0	0	0	0	0	0	0	0	0	0	0	0

#### TOV[12]:

PWM turns counter overflow error enable.  
Duty cycle 72.5%, if PWI.PEO and PWI.PES are “1”.

Value	Description
0	PWM does not respond to a TOV error
1	PWM output respond to a TOV error

#### MSH[10]:

PWM magnetic sense high error enable.  
Duty cycle 61.25%, if PWI.PEO and PWI.PES are “1”.

Value	Description
0	PWM does not respond to a MSH error
1	PWM output respond to a MSH error

#### TR[11]:

PWM Temperature out of range error enable.  
Duty cycle 66.875%, if PWI.PEO and PWI.PES are “1”.

Value	Description
0	PWM does not respond to a TR error
1	PWM output respond to a TR error

#### SAT[9]:

PWM saturation error enable.  
Duty cycle 55.625%, if PWI.PEO and PWI.PES are “1”.

Value	Description
0	PWM does not respond to a SAT error
1	PWM output respond to a SAT error

### ESE[8]:

PWM EEPROM soft error enable.  
Duty cycle 50%, if PWI.PEO and PWI.PES are "1".

Value	Description
0	PWM does not respond to a ESE error
1	PWM output respond to a ESE error

### MSL[7]:

PWM magnetic sense low error enable.  
Duty cycle 44.375%, if PWI.PEO and PWI.PES are "1".

Value	Description
0	PWM does not respond to a MSL error
1	PWM output respond to a MSL error

### UV[6]:

PWM undervoltage error enable.  
Duty cycle 38.75%, if PWI.PEO and PWI.PES are "1".

Value	Description
0	PWM does not respond to an UV error
1	PWM output respond to a UV error

### AVG[5]:

PWM averaging error enable.  
Duty cycle 33.125%, if PWI.PEO and PWI.PES are "1".

Value	Description
0	PWM does not respond to a AVG error
1	PWM output respond to a AVG error

### ZIE[4]:

PWM zero crossing error enable.  
Duty cycle 27.5%, if PWI.PEO and PWI.PES are "1".

Value	Description
0	PWM does not respond to a ZIE error
1	PWM output respond to a ZIE error

### PLK[3]:

PWM PLL lost lock error enable.  
Duty cycle 21.875%, if PWI.PEO and PWI.PES are "1".

Value	Description
0	PWM does not respond to a PLK error
1	PWM output respond to a PLK error

### STF[2]:

PWM Self test error enable.  
Duty cycle 16.25%, if PWI.PEO and PWI.PES are "1".

Value	Description
0	PWM does not respond to a STF error
1	PWM output respond to a STF error

### EUE[1]:

PWM EEPROM uncorrectable error enable.  
Duty cycle 10.625%, if PWI.PEO and PWI.PES are "1".

Value	Description
0	PWM does not respond to a EUE error
1	PWM output respond to a EUE error

### OFE[0]:

PWM Oscillator frequency error enable.  
Duty cycle 5%, if PWI.PEO and PWI.PES are "1".

Value	Description
0	PWM does not respond to a OFE error
1	PWM output respond to a OFE error

### Address 0x19(ABI) – ABI Control

Bit	23	22	21	20	19	18	17	16	15	14	13	12	11	10	9	8	7	6	5	4	3	2	1	0	
Name	-	-	ABI_SLEW_TIME							INV	-X-	-X-	AHE	-	-	INDEX_MODE		WDH	PLH	IOE	UVW	RESOLUTION_PAIRS			
Default	-	-	0	0	1	0	0	0	0	-	-	1	0	0	0	0	0	0	0	1	0	0	1	0	0

#### ABI\_SLEW\_TIME[21:16]:

ABI slew time rate. “0” disables slew limiting.  
Minimum edged-to-edge time for ABI output is defined by:

$$(N + 1) \times 125 \text{ ns}$$

where “N” is the value of ABI\_SLEW\_TIME.  
This limits the maximum ABI velocity. Reducing the ABI resolution can be used to counteract this.

Value	Description
00 0000	Slew limiting disable
00 0001	250 ns of slew control
...	...
11 1111	8 μs of slew control

#### INV[15]:

Invert ABI/UVW signals.

Value	Description															
0	ABI/UVW signals behave as shown below for an increasing angle value. Q1 through Q4 represent changes in angle at the ABI resolution.															
	<table border="1"> <thead> <tr> <th>State Name</th> <th>A</th> <th>B</th> </tr> </thead> <tbody> <tr> <td>Q1</td> <td>0</td> <td>0</td> </tr> <tr> <td>Q2</td> <td>0</td> <td>1</td> </tr> <tr> <td>Q3</td> <td>1</td> <td>1</td> </tr> <tr> <td>Q4</td> <td>1</td> <td>0</td> </tr> </tbody> </table>	State Name	A	B	Q1	0	0	Q2	0	1	Q3	1	1	Q4	1	0
	State Name	A	B													
	Q1	0	0													
	Q2	0	1													
Q3	1	1														
Q4	1	0														
1	ABI/UVW signals are inverted and behave as shown below for an increasing angle value. Q1 through Q4 represent changes in angle at the ABI resolution.															
	<table border="1"> <thead> <tr> <th>State Name</th> <th>A</th> <th>B</th> </tr> </thead> <tbody> <tr> <td>Q1</td> <td>1</td> <td>1</td> </tr> <tr> <td>Q2</td> <td>1</td> <td>0</td> </tr> <tr> <td>Q3</td> <td>0</td> <td>0</td> </tr> <tr> <td>Q4</td> <td>0</td> <td>1</td> </tr> </tbody> </table>	State Name	A	B	Q1	1	1	Q2	1	0	Q3	0	0	Q4	0	1
	State Name	A	B													
	Q1	1	1													
	Q2	1	0													
Q3	0	0														
Q4	0	1														

#### AHE[12]:

ABI hysteresis enable. When “1” hysteresis is applied to the ABI or UVW angle.

Value	Description
0	Hysteresis is not applied to ABI or UVW
1	Hysteresis applied to ABI or UVW outputs

#### INDEX\_MODE[9:8]:

Defines the width and placement of the “I” pulse in ABI.

Value	Description
0	“I” pulse is set only at 0° to +R
1	“I” pulse set between –R to +R
2	“I” pulse set between –R to +2R
3	“I” pulse set between -2R and +2R

“R” indicates the ABI quadrature resolution.

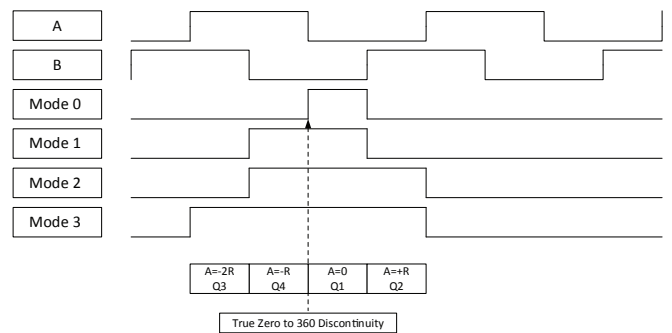

#### WDH[7]:

Enable ABI all high (before inversion) as error mode if oscillator frequency watchdog error trips.

Value	Description
0	ABI pins do not respond to an OFE Flag
1	ABI outputs go high if an OFE is detected

#### PLH[6]:

Enable ABI all high (before inversion) as error mode if a PLL loss of lock is detected.

Value	Description
0	ABI pins do not respond to an PLK Flag
1	ABI outputs go high if the PLK flag is set

#### IOE[5]:

Incremental output enable.

Value	Description
0	ABI/UVW pins are not active
1	ABI/UVW pins are active. Behavior defined by ABI.UVW bit



### UVW[4]:

Define behavior of the ABI/UVW pins. If ABI.IOE = 1.

Value	Description
0	ABI active
1	UVW active

### RESOLUTION\_PAIRS[3:0]:

Defines resolution of ABI/UVW outputs.

In ABI mode, cycle resolution =  $2^{(14-n)}$  where "n" is the RESOLUTION\_PAIRS value.

In UVW mode, the number of pole pairs is  $n + 1$ .

Value	AB Cycles per Rev	UVW Pole Pairs
0000	N/A	1
0001	N/A	2
0010	N/A	3
0011	$2^{11} = 2048$	4
0100	$2^{10} = 1024$	5
...	...	...
1110	$2^0 = 1$	15
1111	N/A	16

### Address 0x1A (MSK) – Mask Bits

This address range contains error mask bits. When set, the applicable error condition will not assert the “EF” bit in the various angle and turns count registers.

Bit	23	22	21	20	19	18	17	16	15	14	13	12	11	10	9	8	7	6	5	4	3	2	1	0
Name	IER	CRC	-X-	SRW	XEE	TR	ESE	SAT	TCW	BSY	MSH	TOV	WAR	STF	AVG	ABI	PLK	ZIE	EUE	OFE	UVD	UVA	MSL	RST
Default	0	0	-	0	0	0	0	0	0	0	0	0	0	0	0	0	0	0	0	0	0	0	0	0

#### IER[23]:

Masks the IER flag from setting the “EF” bit.

#### CRC[22]:

Masks the CRC flag from setting the “EF” bit.

#### SRW[20]:

Masks the SRW flag from setting the “EF” bit.

#### XEE[19]:

Masks the XEE flag from setting the “EF” bit.

#### TR[18]:

Masks the TR flag from setting the “EF” bit.

#### ESE[17]:

Masks the ESE flag from setting the “EF” bit.

#### SAT[16]:

Masks the SAT flag from setting the “EF” bit.

#### TCW[15]:

Masks the TCW flag from setting the “EF” bit.

#### BSY[14]:

Masks the BSY flag from setting the “EF” bit.

#### MSH[13]:

Masks the MSH flag from setting the “EF” bit.

#### TOV[12]:

Masks the TOV flag from setting the “EF” bit.

#### WAR[11]:

Masks the WAR flag from setting the “EF” bit.

#### STF[10]:

Masks the STF flag from setting the “EF” bit.

#### AVG[9]:

Masks the AVG flag from setting the “EF” bit.

#### ABI[8]:

Masks the ABI flag from setting the “EF” bit.

#### PLK[7]:

Masks the PLK flag from setting the “EF” bit.

#### ZIE[6]:

Masks the ZIE flag from setting the “EF” bit.

#### EUE[5]:

Masks the EUE flag from setting the “EF” bit.

#### OFE[4]:

Masks the OFE flag from setting the “EF” bit.

#### UVD[3]:

Masks the UVD flag from setting the “EF” bit.

#### UVA[2]:

Masks the UVA flag from setting the “EF” bit.

#### MSL[1]:

Masks the MSL flag from setting the “EF” bit.

#### RST[0]:

Masks the RST flag from setting the “EF” bit.

### Address 0x1B (PWI) – PWM Interface Control

Bit	23	22	21	20	19	18	17	16	15	14	13	12	11	10	9	8	7	6	5	4	3	2	1	0
Name	PEN	PWM_BAND			PWM_FREQ				-	PHE	PEO	PES	-	-	-	-	-	-	-	-	DM	-	S17	SC
Default	0	1	1	0	0	1	1	1	0	0	0	0	0	0	0	1	0	0	0	0	0	0	0	0

#### PEN[23]:

PWM Enable.

Value	Description
0	PWM pin tri-stated
1	PWM enabled

#### PWM\_BAND[22:20]:

PWM frequency band. Defines the PWM carrier frequency when combined with PWM\_FREQ.

#### PWM\_FREQ[19:16]:

PWM frequency select. Defines the PWM carrier frequency when combined with PWM\_BAND.

**Table 15: Nominal PWM Carrier Frequencies**

		PWM_BAND							
		0	1	2	3	4	5	6	7
PWM_FREQ	0	3125	2778	2273	1667	1087	641	352	185
	1	3101	2740	2222	1613	1042	610	333	175
	2	3077	2703	2174	1563	1000	581	316	166
	3	3053	2667	2128	1515	962	556	301	157
	4	3030	2632	2083	1471	926	532	287	150
	5	3008	2597	2041	1429	893	510	275	143
	6	2985	2564	2000	1389	862	490	263	137
	7	2963	2532	1961	1351	833	472	253	131
	8	2941	2500	1923	1316	806	455	243	126
	9	2920	2469	1887	1282	781	439	234	121
	10	2899	2439	1852	1250	758	424	225	116
	11	2878	2410	1818	1220	735	410	217	112
	12	2857	2381	1786	1190	714	397	210	108
	13	2837	2353	1754	1163	694	385	203	105
	14	2817	2326	1724	1136	676	373	197	101
	15	2797	2299	1695	1111	658	362	191	98

#### PHE[14]:

PWM Hysteresis enable.

Value	Description
0	No hysteresis applied to PWM output
1	Hysteresis settings applied to PWM output

#### PES[12]:

PWM Error Select, if PEO = 1.

Value	Description
0	PWM output tri-states for all enabled error conditions (See PWE address space).
1	For all enabled errors the PWM carrier frequency is halved and the highest priority error is identified by a specific duty cycle. See the PWE address space description.

#### PEO[13]:

PWM Error Output Enable. If "1" PWM will respond to errors, as defined by the PES bit.

Value	Description
0	PWM output does not respond to error flags
1	PWM output will respond to errors, as defined by the PWI. PES field.

### DM[3]:

Disable Manchester Interface.

Value	Description
0	Manchester functions normally
1	A1333 will no longer respond to Manchester command on the $V_{CC}$ line

### S17[1]:

A1333 ignores the 17<sup>th</sup> SPI clock. Allows negative edge sampling at the MCU (host).

### Address 0x1C (ANG)

Bit	23	22	21	20	19	18	17	16	15	14	13	12	11	10	9	8	7	6	5	4	3	2	1	0	
Name	ORATE				RD	RO	HYSTERESIS						ZERO_OFFSET												
Default	0	0	0	0	0	0	1	0	1	0	0	0	0	0	0	0	0	0	0	0	0	0	0	0	0

### ORATE[23:20]:

Reduces the output rate by averaging samples.  $2^{ORATE}$  samples will be averaged. ORATE values above 12 are reduced to 12 in the logic, meaning that up to 4096 samples = 4 ms can be selected as averaging time.

Value	Description
0000	1 sample. 1 $\mu$ s update rate.
0001	2 samples. 2 $\mu$ s update rate.
0010	4 samples. 4 $\mu$ s update rate.
...	...
1100	4096 samples. $\approx$ 4 ms update rate.

The majority of angle noise is composed of low-frequency content. Due to this, noticeable improvements in IC resolution are not observed until relatively high values of ORATE (8 or above, corresponding to 256 samples). Because of this, non-zero ORATE settings are not recommended, except in cases where sensor response time is not a major concern (i.e. low rpm applications).

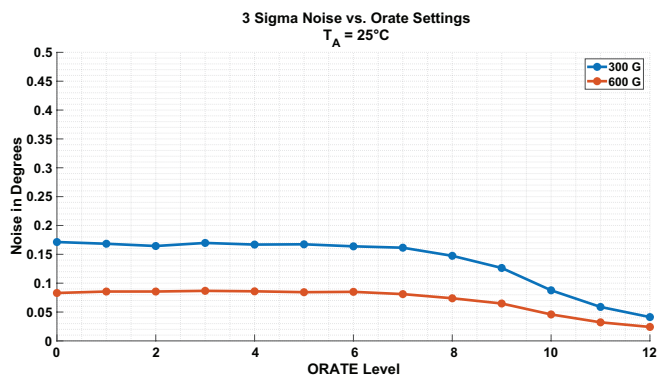

### SC[0]:

A1333 monitors the incoming CRC.

Value	Description
0	No monitoring of the incoming CRC
1	A1333 monitors incoming CRC. Discards packet if corrupt.

### RD[19]:

Rotates die. Rotates final angle 180°. Last step in the angle algorithm. This is a convenient setting to adjust one die in a dual die package for conformance to the other die. Occurs after the Zero\_offset and RO adjustments.

Value	Description
0	No rotation applied
1	180° added to final angle

### RO[18]:

Rotation Direction. If set to 0, increasing angle movement is in the clockwise direction when looking down on the top of the die. If set to 1, increasing angle movement is in the counter-clockwise direction. Occurs after the Zero\_offset adjust and prior to the RD manipulation.

Value	Description
0	Output angle increases with a clockwise rotation (when viewed from above the magnet and device)
1	Output angle increases with a counter-clockwise rotation (when viewed from above the magnet and device)

### HYSTERESIS[17:12]:

Angle Hysteresis threshold. In 14bit resolution. Provides  $\approx$ 0 to 1.384° of hysteresis.

Value	Description
00 0000	No Hysteresis
00 0001	$\approx$ 0.022° of Hysteresis
...	...
11 1111	$\approx$ 1.384° of Hysteresis

### ZERO\_OFFSET[11:0]:

Post-compensation zero offset (or DC adjust), at 12-bit resolution. This value is subtracted from the measured angle value. Operation occurs prior to the RD and RO manipulations.

# A1333

## Precision, High Speed, Hall-Effect Angle Sensor IC with Integrated Diagnostics for Safety-Critical Applications

### Address 0x1D (LPC)

Bit	23	22	21	20	19	18	17	16	15	14	13	12	11	10	9	8	7	6	5	4	3	2	1	0
Name	T45	-	-	-	-	-	-	-	-	-	-	-	-	-	-	-	-	-	-	-	-	-	-	-
Default	1	-	0	0	0	0	0	0	1	0	1	1	0	0	1	0	1	0	0	1	1	1	1	1

### T45[23]:

Defines the resolution of the turns counter.

Value	Description
0	Turns counter measures 180° of rotation
1	Turns counter measures 45° of rotation

### Address 0x1E (COM)

Bit	23	22	21	20	19	18	17	16	15	14	13	12	11	10	9	8	7	6	5	4	3	2	1	0
Name	LOCK				LBE	CSE	-	-	-	-	DST	DHR	MAG_THRES_HI						MAG_THRES_LO					
Default	0	0	0	0	1	1	-	-	-	-	0	0	1	0	0	1	0	1	0	0	1	1	0	1

#### LOCK[23:20]:

EEPROM and Shadow memory lock.  
Permanent lock.

Value	Description
1100	Writing to EEPROM is locked
0011	Writing to EEPROM and Shadow memory is locked

#### LBE[19]:

Power-up Logic BIST enable.  
LBIST requires ≈30 ms to run.

Value	Description
0	LBIST isn't run on power-up
1	LBIST is run on power-up

LBIST and CVH self-test are run in parallel. Therefore if both are enabled on power-up, power-on time is ≈30 ms.

#### CSE[18]:

Power-up CVH self-test enable.  
CVH self-test requires ≈30 ms to run.

Value	Description
0	CVH is not run on power-up
1	CVH is run on power-up

LBIST and CVH self-test are run in parallel. Therefore, if both are enabled on power-up, power-on time is ≈30 ms.

#### DST[13]:

Disable Self-test initiation from the serial register.

Value	Description
0	Self-tests may be initiated via a "special" serial register command.
1	Prevents running either LBIST or CVH self-test from the CTRL register.

#### DHR[12]:

Disable Hard reset from the serial register.

Value	Description
0	A Hard reset may be initiated via a "special" serial register command.
1	Prevents initiating a Hard reset from the CTRL register.

#### MAG\_THRES\_HI[11:6]:

Magnetic threshold high value. Determine set-point of the MSH flag. When set to 0, check is disabled.

Limit increases in 32 G increments. Set to 1184 G at factory.

Value	Description
00 0000	High field flag disabled
00 0001	32 G
00 0010	64 G
...	...
10 0101	1184 G
...	...
11 1111	2016 G

#### MAG\_THRES\_LO[5:0]:

Magnetic threshold low value. Determine set-point of the MSL flag. When set to 0, check is disabled.

Limit increased in 16 G increments. Set to 208 G at factory.

Value	Description
00 0000	Low field flag disabled
00 0001	16 G
00 0010	32 G
...	...
00 1101	208 G
...	...
11 1111	1008 G

### Address 0x1F (CUST)

Bit	23	22	21	20	19	18	17	16	15	14	13	12	11	10	9	8	7	6	5	4	3	2	1	0
Name	Customer EEPROM Space																							
Default	0	0	0	0	0	0	0	0	0	0	0	0	0	0	0	0	0	0	0	0	0	0	0	0

#### CUSTOMER[23:0]:

Customer EEPROM space.

## SAFETY AND DIAGNOSTICS

The A1333 was developed in accordance with the ASIL design flow (ISO 26262) and incorporates several internal diagnostics as well as error/warning/status flags enabling the host microcontroller to assess the operational status of the die.

A short summary of the A1333 diagnostics is provided below. A complete listing and discussion of the A1333 safety features may be found in the “A1333 Safety Manual”, which is available upon request.

### Built-In Self-Tests

The A1333 features two built-in-self-tests (BISTS) which may be configured to run at power-up and may also be initiated at any time by the system microcontroller via a serial register write. A failure of any one of the self-tests will assert the Self-Test Failure Flag, STF, within the Error register.

### CVH SELF-TEST

CVH self-test is a method of verifying the operation of the CVH transducer without applying an external magnetic field. This feature is useful for both manufacturing test and for integration debug. The CVH self-test is implemented by changing the switch configuration from the normal operating mode into a test configuration, allowing a test current to drive the CVH in place of the magnetic field. By changing the direction of the test current and by changing the elements in the CVH that are driven, the self-test circuit emulates a changing angle of magnetic field. The mea-

sured angle is monitored to determine a passing or failing device.

CVH self-test typically takes 30 ms to run (when run in parallel with LBIST, entire test time is 30 ms).

### LOGIC BUILT-IN SELF-TEST (LBIST)

Logic BIST is implemented to verify the integrity of the A1333 logic. It can be executed in parallel with the CVH self-test. LBIST is effectively a form of auto-driven scan. The logic to be tested is broken into 31 scan chains. The chains are fed in parallel by a 31-bit linear feedback shift register (LFSR) to generate pseudo-random data. The output of the scan chains are fed back into a multiple input shift register (MISR) that accumulates the shifted bits into a 31-bit signature.

LBIST takes  $\approx 30$  ms to complete (when run in parallel with CHV self-test, the entire test time is  $\approx 30$  ms).

### Status, Error, and Warning Flags

The A1333 features many flags used to detect faulty external or internal conditions. Table 16 briefly describes a selection.

All flags may be read through the serial registers via SPI or Manchester communication. All unmasked error flags will assert the “General Error” flag which is included in the angle register (0x20), providing a “snapshot” of the sensor’s status.

Error reporting when using PWM or ABI is more limited and discussed later on.

**Table 16: Status and Error Flags**

Fault Condition	Description	Sensor Response
$V_{CC} < V_{UVD}$	Indicates $V_{CC}$ is below expected level.	UVD flag set in ERR register UV flag set in ANG register EF flag set in ANG register
Field > High Threshold	Sensor monitors field level in case of mechanical failure. High Level is programmable from 0-2016 G in 32 G steps. By default set to $\approx 1184$ G.	MSH flag set in WARN register EF flag set in ANG register
Field < Low Threshold	Sensor monitors field level in case of mechanical failure. Low Level is programmable from 0-1008 G in 16 G steps. By default set to $\approx 208$ G.	MSL flag set in ERR register EF flag set in ANG register
$T_A < -60^\circ\text{C}$ or $T_A > 180^\circ\text{C}$	Ambient temperature beyond maximum detectable value.	TR flag set in WARN register EF flag set in ANG register
Oscillator Frequency Discrepancy	The A1333 cross-checks the high and low frequency oscillators for proper functionality.	OFE flag set in ERR register EF flag set in ANG register
Single Bit EEPROM Error (correctable)	Detects and corrects single bit EEPROM errors.	ESE bit set in WARN register EF flag set in ANG register
Multi-Bit EEPROM failure (uncorrectable)	Detects multi-bit EEPROM errors.	EUE bit set in ERR register EF flag set in ANG register
Signal Path Failure	Multiple comparisons and checks within the signal path: <ul style="list-style-type: none"> <li>• Main signal path output compared to the ZCD signal path</li> <li>• PLL lock status monitored</li> <li>• Main signal path is checked for saturation</li> </ul>	PLK or ZIE set within the ERR register EF flag set within the ANG register
Loss of $V_{CC}$	Determines if system power was lost. Indicates all volatile registers have been reset (such as turns count).	RST bit set in ERR register EF flag set in ANG register
ABI Integrity Fault	Excessive noise or excessive rotational velocity for a given ABI resolution. IC monitors state of ABI and flags skipped states.	ABI bit set in ERR register EF flag set in ANG register
Analog regulator drift	IC monitors output of analog regulator, ensuring transducer is supplied with proper voltage.	UVA bit set in ERR register UV flag set in ANG register EF flag set in ANG register
Excessive magnet travel	Sensor detects when > 256 rotations have occurred, indicating the turns counter has saturated.	TOV bit set in WARN register EF flag set in ANG register
Excessive magnet velocity for turns counting	If the sensor detects > $135^\circ$ travel between successive turns count updates.	TCW bit set in WARN register EF flag set in ANG register
Excessive magnet velocity for a given ORATE setting	Indicates the angle reading spanned more than 2 quadrants during the ORATE sample period, therefore the average may be incorrect. Can occur under extreme velocity and high averaging, or with no magnetic field and the samples out of the CVH are random.	AVG bit set in ERR register EF flag set in the ANG register
Incoming SPI Packet Corruption	IER error detects an invalid number of SCLKs, or a '1' in the MSB on MOSI. If using 20-bit SPI packets and incoming CRC validation is enabled (SC bit in EEPROM 0x1B), the CRC flag will assert.	Depending on implementation and amount of corruption: IER bit set in WARN register CRC bit set in WARN register EF flag set in ANG register



### ERROR REPORTING IN PWM

The PWM output can be configured to change state if certain errors occur. There are three options:

- No error reporting
- Tristate the PWM
- Halve the carrier frequency and represent the error via different duty cycles

Two EEPROM bits, “PEO” and “PES” control how errors are reported in PWM mode, both of which are in the PWS address row of EEPROM:

**Table 17: PWM Error Output Enable Option (PEO)**

Code	Description
0	PWM does not respond to errors.
1	PWM output responds to errors as selected with the PES field.

**Table 18: PWM Error Select (PES)**

Code	Description
0	PWM tristates on an error.
1	PWM carrier frequency halved and highest priority error output on PWM as selected duty cycle.

The error priority and corresponding duty cycle are shown in Table 19 below, with the high priority error dictating the PWM duty cycle.

Each error code must be enabled via EEPROM. This prevents losing the PWM output due to a spurious error.

The enable bits can be found within the PWE (0x18) EEPROM row.

**Table 19: PWM Error Duty Cycle and Priority**

Error	Priority	Duty Cycle %	Description / Persistence
OFE	1 (highest)	5	Watchdog error. Permanent.
EUE	2	10.625	EEPROM uncorrectable error. Permanent.
STF	3	16.25	Self-test failure. Permanent.
PLK	4	21.875	PLL not locked. Persists until PLL locks.
ZIE	5	27.5	Zero-crossing integrity error. Persists until goes away.
AVG	6	33.125	Angle averaging error. Outputs once then clears.
UV	7	38.75	Undervoltage (UVA and/or UVCC dependent on serial error masks). Persists until no unmasked undervoltage.
MSL	8	44.375	Persists until field strength higher than low threshold.
ESE	9	50	EEPROM correctable error. Outputs once then clears.
SAT	10	55.625	Persists until no saturation warnings.
MSH	11	61.25	Persists until field strength lower than high threshold.
TR	12	66.875	Persists until temperature within range.
TOV	13 (lowest)	72.5	Turns counter overflow. Persists until cleared via CTRL register.

**ERROR REPORTING IN ABI/UVW**

Error reporting when using ABI/UVW requires the transmission of angle information to be interrupted. As a result, only the two most severe errors are allowed to interrupt the pulse stream, preventing potential spurious errors from interrupting the primary mission of the IC.

As further insurance against undesired ABI/UVW interruption, error reporting must be individually enabled in EEPROM. The error conditions which may be reported are:

- Oscillator Frequency Error
- PLL Loss of Lock Error

When enabled, and an error occurs, all three ABI lines will be brought high (prior to inversion, if enabled). This is an undefined state in both ABI (if using default I mode width) and UVW.

Error reporting is enabled via the following two EEPROM bits, housed within address row 0x19.

**WDH[7]:**

Enable ABI all high (before inversion) as error mode if oscillator frequency watchdog error trips.

Value	Description
0	ABI pins do not respond to an OFE Flag
1	ABI outputs go high if an OFE is detected

**PLH[6]:**

Enable ABI all high (before inversion) as error mode if a PLL loss of lock is detected.

Value	Description
0	ABI pins do not respond to an PLK Flag
1	ABI outputs go high if the PLK flag is set

## APPLICATION INFORMATION

The A1333 features SPI, PWM, ABI/UVW, and Manchester outputs. Basic reference circuits for connecting the A1333 are shown below in Figure 56.

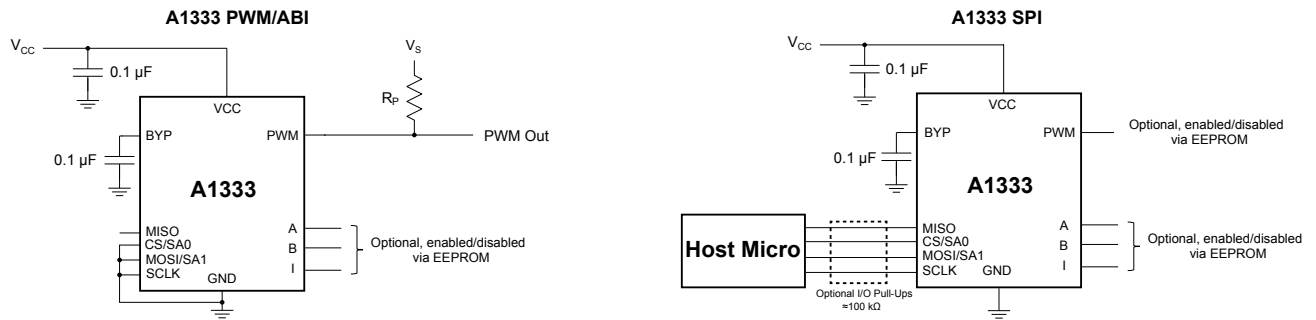

Typical A1333 configuration using PWM output.  
Digital reads/writes requests transmitted via Manchester encoding on the V<sub>CC</sub> line.  
SA0/SA1 brought to BYP or GND to configure Manchester address.

Typical A1333 configuration using SPI interface.

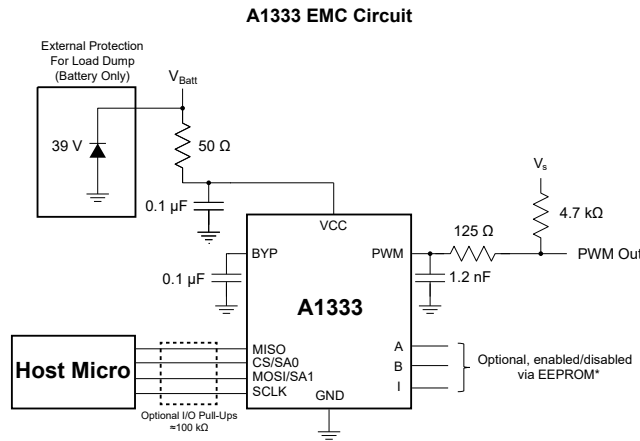

A1333 reference design for stringent EMC requirements.  
\*If using ABI outputs, a 10 nF capacitor to GND on each line is recommended (this added capacitance will reduce the edge rates on ABI).

Figure 56: A1333 PWM/ABI, SPI, and EMC Application Circuits

## ESD Performance

Table 20 shows the ESD performance of the A1333 device. Contact Allegro for questions regarding ESD optimization.

Table 20: HBM ESD Rating (per AEC-Q100 002)

Package	ESD Rating
TSSOP-14	5 kV
eTSSOP-24	3 kV [1]

[1] With GND pins of both die shorted together, IC performs to a 4 kV level.

### Setting the Zero-Degree Position

When shipped from the factory, the default angle value when oriented as shown in Figure 57 is 0° for both die. In some cases, the end user may want to program an angle offset in the A1333 to compensate for variations in magnetic assemblies, or for applications where absolute system-level readings are required.

The internal algorithm for computing the output angle is as follows:

$$Angle_{out} = Angle_{RAW} - ZERO\_OFFSET$$

where ZERO\_OFFSET is a 12-bit field in EEPROM.

To “zero out” the A1333 reported angle, during final application calibration, position the magnet above the A1333 in the desired zero-degree position and read the reported angle. This angle becomes the necessary ZERO\_OFFSET value to “zero-out” the angle.

In some cases, it may be convenient to have a 180° offset between die. The RD field (bit 19 of EEPROM location 0x19) allows a 180° offset to be applied. When set, this bit adds 180° to the output of the die (occurs after ZERO\_OFFSET and rotation adjustments).

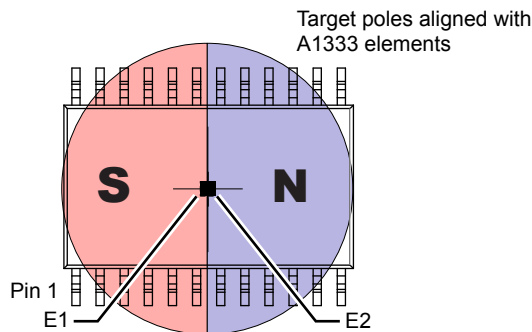

**Figure 57: Orientation of Magnet Relative to Primary and Secondary Die**

### Magnetic Target Requirements

The A1333 is designed to operate with magnets constructed with a variety of magnetic materials, geometries, and field strengths. See Table 21 for a list of common magnet dimensions.

The A1333 actively measures and adapts to its magnetic environment. This allows operation throughout a large range of field strengths (recommended range is 300 to 1000 G, operation

beyond this range will not result in long term damage). Due to the greater signal-to-noise ratio provided at higher field strengths, performance inherently increases with increasing field strength. Typical angle performance over applied field strength is shown in Figure 59 and Figure 60.

**Table 21: Target Magnet Parameters**

Magnetic Material	Diameter (mm)	Thickness (mm)
Neodymium (sintered)*	10	2.5
Neodymium (sintered)	8	3
Neodymium / SmCo	6	2.5

\* A sintered Neodymium magnet with 10 mm (or greater) diameter and 2.5 mm thickness is the recommended magnet for redundant applications.

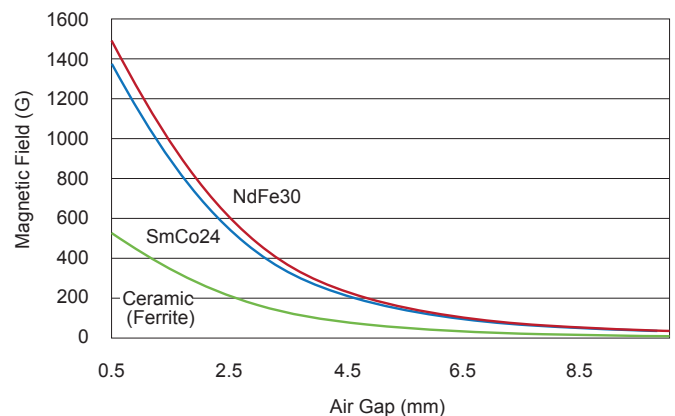

**Figure 58: Magnetic Field versus Air Gap for a magnet 6 mm in diameter and 2.5 mm thick.**

Allegro can provide similar curves for customer application magnets upon request. Allegro recommends larger magnets for applications that require optimized accuracy performance.

### Magnet Misalignment

Magnetic misalignment with the A1333 package impacts the linearity of the observed magnetic signal and consequently the resulting accuracy. The influence of mechanical misalignment may be minimized by reducing the overall airgap and by choosing

a larger magnet diameter. Figure 59 shows the influence of magnet diameter of eccentricity error.

The dual die variant of the A1333 uses a stacked die approach, resulting in a common eccentricity value for both die. This eliminates the “native misalignment” present in “side-by-side” packaging options.

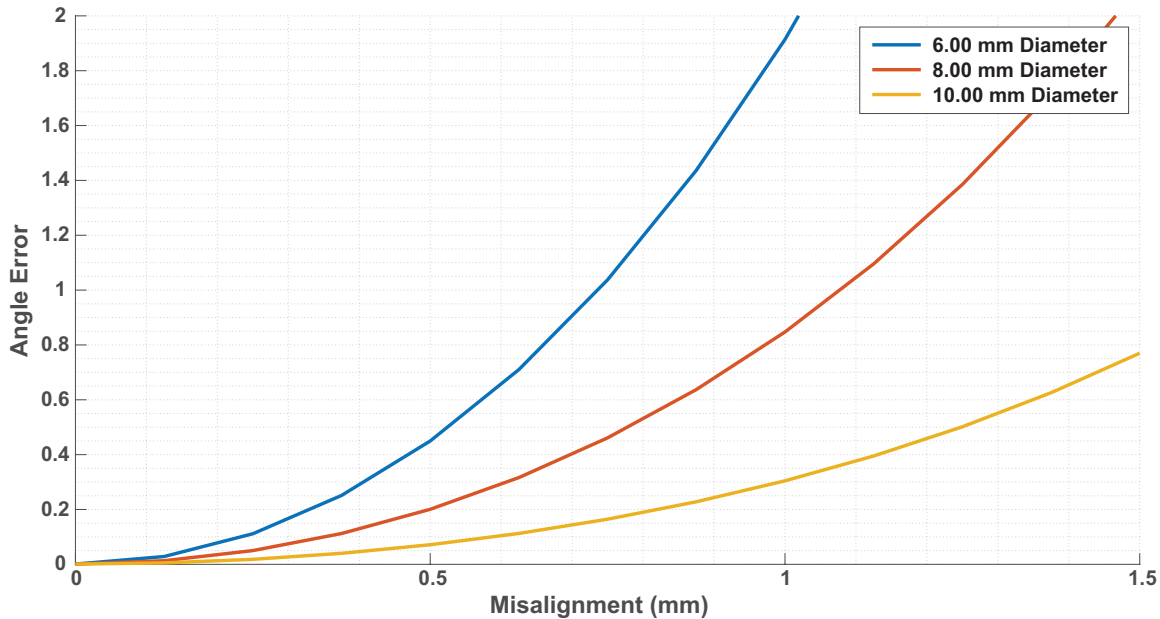

**Figure 59: Simulated Error versus Eccentricity for different size magnet diameters, at 2.0 mm air gap**

Typical Systemic Error versus magnet to sensor eccentricity ( $d_{axial}$ ). Note: “Systemic Error” refers to application errors in alignment and system timing. It does not refer to sensor IC device errors. The data in this graph is simulated with ideal magnetization.

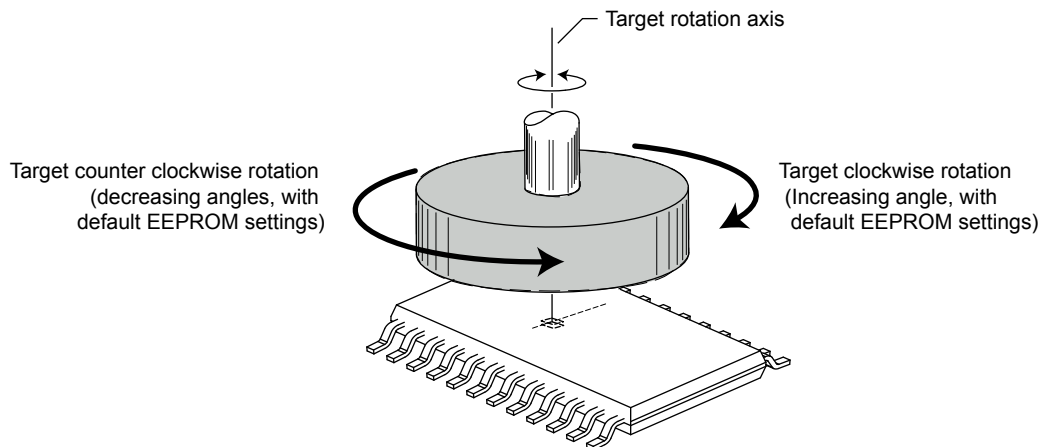

**Figure 60: Rotation Direction Definition**

I/O STRUCTURES

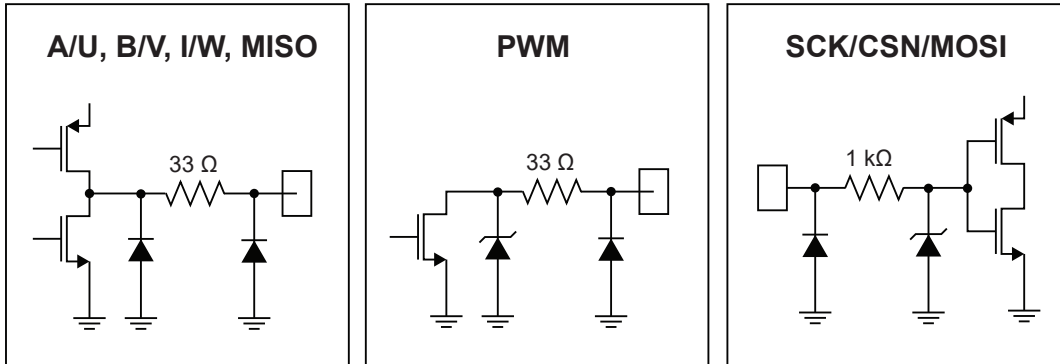

## PACKAGE OUTLINE DRAWINGS

**For Reference Only – Not for Tooling Use**

(Reference MO-153 ADT)

NOT TO SCALE

Dimensions in millimeters

Dimensions exclusive of mold flash, gate burrs, and dambar protrusions

Exact case and lead configuration at supplier discretion within limits shown

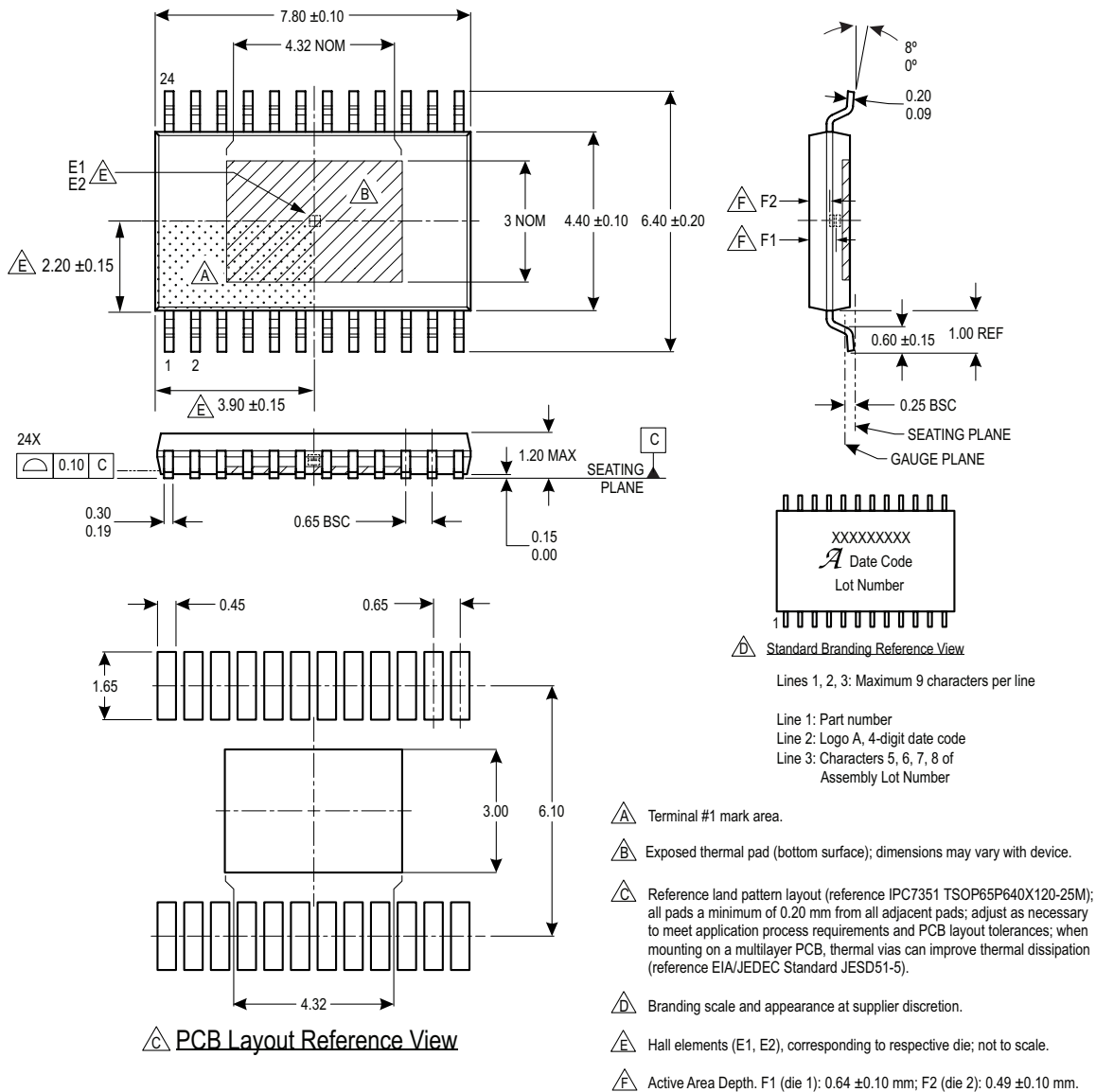
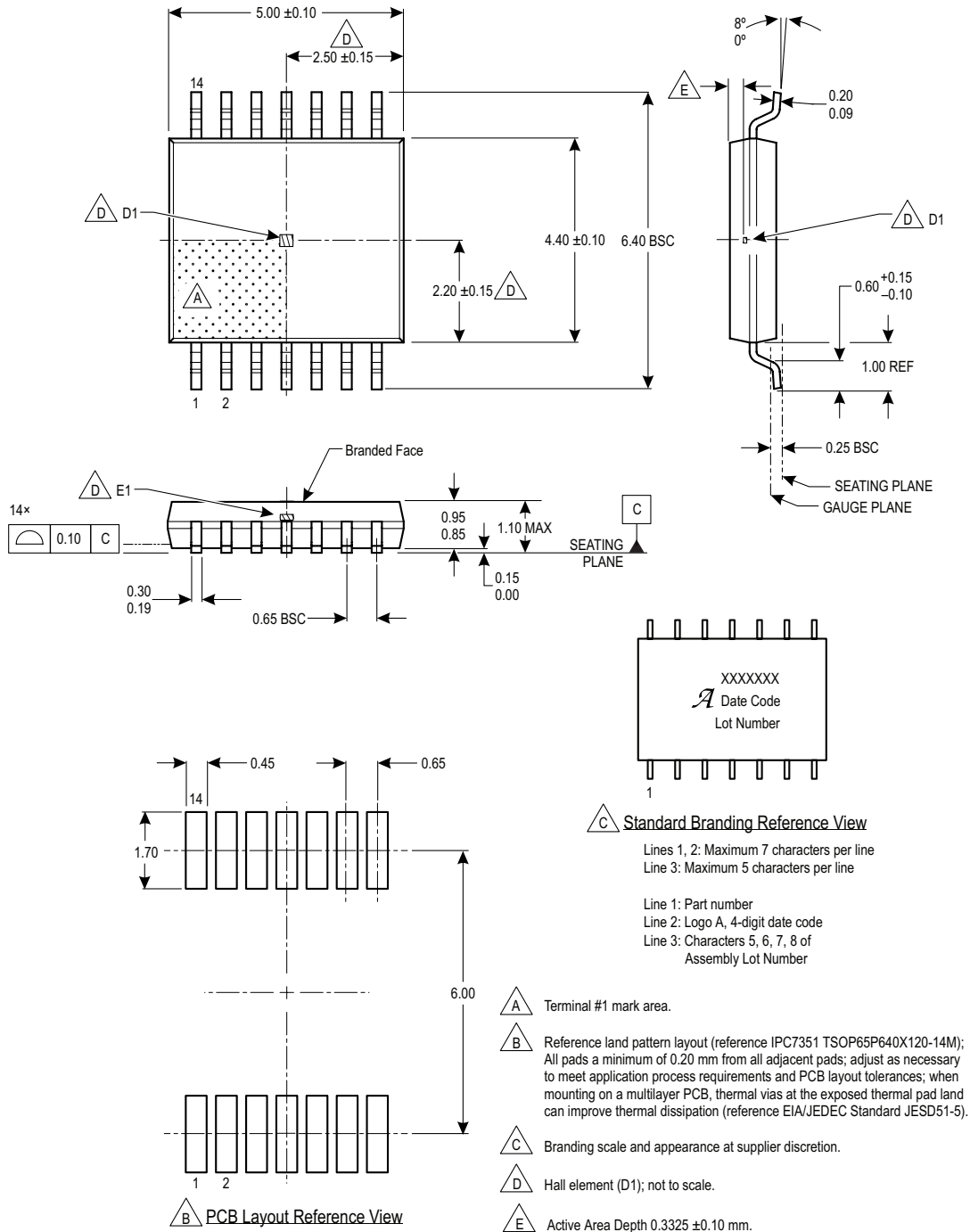

**Figure 61: Package LP, 24-Pin TSSOP with Exposed Thermal Pad**

### For Reference Only – Not for Tooling Use

(Reference Allegro DWG-0000381, Rev. 1)  
Dimensions in millimeters – NOT TO SCALE

Dimensions exclusive of mold flash, gate burrs, and dambar protrusions  
Exact case and lead configuration at supplier discretion within limits shown



**Figure 62: Package LE, 14-Pin TSSOP**



APPENDIX A: ANGLE ERROR AND DRIFT DEFINITION

Angle error is the difference between the actual position of the magnet and the position of the magnet as measured by the angle sensor IC (without noise). This measurement is done by reading the angle sensor IC output and comparing it with a high resolution encoder (refer to Figure 63).

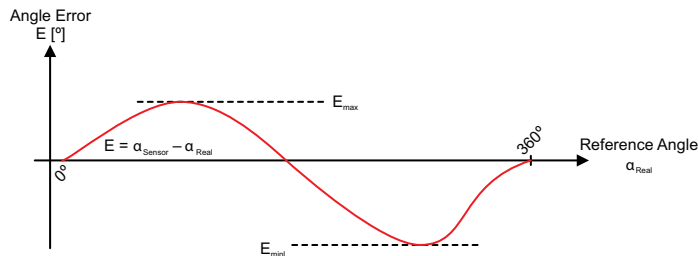

Figure 63: Angle Error Definition

Angle Error Definition

Throughout this document, the term “angle error” is used extensively. Thus, it is necessary to introduce a single angle error definition for a full magnetic rotation. The term “angle error” is calculated according to the following formula:

$$AngleError = \max(|E_{max}|, |E_{min}|)$$

In other words, it is the maximum deviation from a perfect straight line between 0 and 360 degrees. For the purposes of a generic definition, the offset of the IC angle profile is removed prior to the error calculation (this can be seen in Figure 63). The offset itself will depend on the starting IC angle position relative to the encoder 0° and thus can differ anywhere from 0-360°.

Angle Drift

Angle drift is the change in the observed angular position over temperature, relative to 25°C.

During Allegro’s factory trim, drift is measured at 150°C. The value is calculated using the following formula:

$$Angle_{Drift} = Angle_{25^{\circ}C} - Angle_{150^{\circ}C}$$

where each Angle value is an array corresponding to 16 angular positions around a circle.

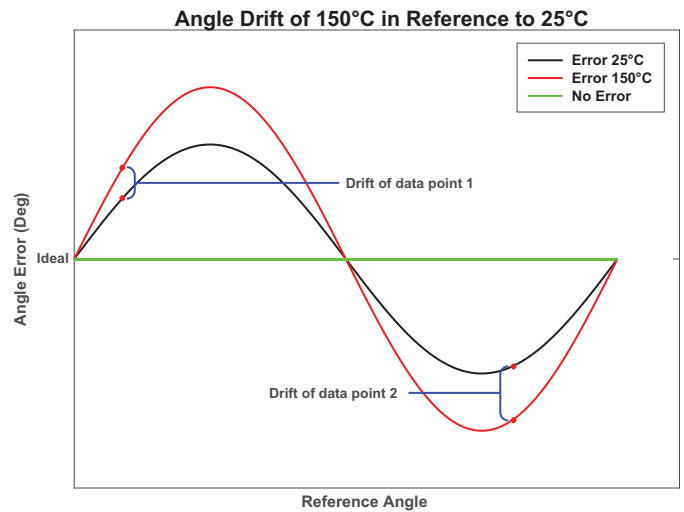

Figure 64: Angle Drift of 150°C in Reference to 25°C [1]

[1] Note that the data above is simply a representation of angle drift and not real data.

## APPENDIX B: SPI INTERFACE ERROR FLAG DESCRIPTION

### IER Flag

The IER flag is located in bit 11 of the WARN serial register (0x26:0x27). This flag is designed to assert when the IC detects an improper communication frame, via either SPI or Manchester. For the purposes of this appendix, only the behavior in regards to the SPI bus will be discussed. The IER flag will assert on the following conditions:

- An improper number of SPI clocks are detected
- The MSB of the MOSI packet is a logic ‘1’

**Table 22: WARN Serial Register**

Address	0x26								0x27							
Bit	15	14	13	12	11	10	9	8	7	6	5	4	3	2	1	0
Name	1	0	1	1	IER	CRC	0	SRW	XEE	TR	ESE	SAT	TCW	BSY	MSH	TOV
R/W	R	R	R	R	R	R	R	R	R	R	R	R	R	R	R	R

### Behavior When Sharing SPI lines

The IER flag may provide an erroneous indication when sharing the SCLK line among multiple ICs. In the case where an IC is held inactive by bringing the CS line high, the inactive IC(s) will continue to count falling SCLK edges. This results in an invalid number of observed SCLK edges, and the IER flag to assert on the next SPI transaction of the IC. False IER flag assertions differ based on the size of the SPI packet.

### SIXTEEN AND SEVENTEEN BIT SPI PACKETS

The IER flag will always assert if, during the CS high period, the SCLK line is brought low as follows:

- At least one time if using a 16-bit SPI packet and the S17 bit is set to ‘0’ (EEPROM 0x1B, bit 1).
  - Default setting for S17 is ‘0’.
- At least twice if using a 16-bit packet and the S17 bit is a ‘1’.
  - Based on signal timing, there is a possibility that the IER flag will assert if SCLK is brought low only once with S17 set.
- At least once if using a 17-bit packet and the S17 bit is a ‘1’.

### Impact of IER flagging with 16/17 Bit Packets

When an incorrect number of SCLK edges is observed by the IC, the following occurs:

1. The IER flag will trigger.
2. If the packet preceding the CS high time is a read:
  - A. If SCLK drops low within 70 ns of the CS rising edge, there is a possibility the read will be discarded. If this occurs, the output will correspond to the last valid read request for that device.
  - B. If the SCLK edge occurs after 70 ns of the CS rising edge, the read is not discarded, potentially corrupting the next immediate response from the device.
3. If the packet preceding the CS high time is a write:
  - A. If SCLK drops low within 70 ns of the CS rising edge, there is a possibility the write will be discarded.
  - B. If the SCLK edge occurs after 70 ns of the CS rising edge, the write will occur, but the IER flag will still assert.

### TWENTY BIT SPI PACKETS

When using 20-bit SPI packets, the IER flag may occur when the SCLK line is brought low while CS is high. The probability of a false IER flag asserting is timing dependent and will differ from device to device, but should not occur on more than 3.2% of all SPI transactions. Lab characterization has shown significantly lower assertion rates, with false flags on 0.00% to 0.80% of all SPI transactions.

### Impact of IER flagging with a 20-Bit Packet

When using a 20-bit SPI packet, the following will occur if an incorrect number of SCLK edges is observed:

1. The IER flag will trigger.
2. If the packet preceding the CS high time is a read:
  - A. If SCLK drops low within 70 ns of the CS rising edge, there is a possibility the read will be discarded. If this occurs, the output will correspond to the last valid read request for that device.
  - B. If the SCLK edge occurs after 70 ns of the CS rising edge, the read will take place as expected.
3. If the packet preceding the CS high time is a write:
  - A. If SCLK drops low within 70 ns of the CS rising edge, there is a possibility the write will be discarded.
  - B. If the SCLK edge occurs after 70 ns of the CS rising edge, the write will occur, but the IER flag will still assert.

## Avoiding IER Flag Assertion

The following methods may be used to avoid false IER flag assertions:

1. Use dedicated SCLK lines for each IC and hold the SCLK line high when CS is high.
  - A. This prevents the IC from seeing SCLK edge transitions when CS is high.

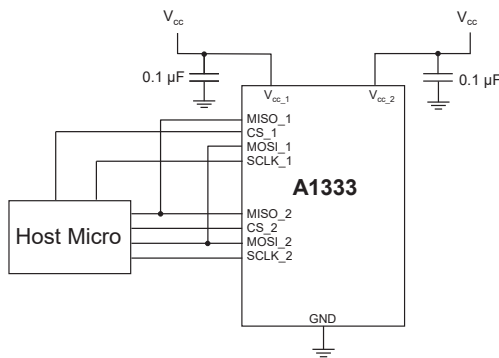

**Figure 65: Separate SCLK Lines**

2. Use a 21-bit SPI packet.
  - A. When using a 21-bit SPI packet, the IC does not count SCLK edges when the CS pin is held high. This prevents the IER flag from improperly asserting, with the exception of power-on.

## USING A 21-BIT SPI PACKET

No special EEPROM programming is required for the A1333 to support a SPI packet size of 21 bits; the master must simply send

21 SCLK pulses during the CS low period. The format of the SPI message is shown in Figure 66.

The Master Output Slave In (MOSI) signal consists of: a 1-bit Sync bit defined as a logic ‘0’, 1-bit  $\bar{R}/W$ , 6 address bits, 8 data bits, 4 CRC bits, and an additional logic ‘0’. The extra logic ‘0’ sent on the 21<sup>st</sup> clock tick effectively shifts the standard 20-bit packet left by one place value.

The Master Input Slave Out (MISO) signal consists of: 16 data bits, the contents of which are determined by the address of the register being read, 4 CRC bits, and a repeat of the MSB of the CRC value shown in bold in Figure 66). The repeated CRC bit shifted out on the 21<sup>st</sup> clock edge should be ignored by the master when processing the CRC to validate the message contents

## POWER-ON BEHAVIOR WITH A 21-BIT SPI PACKET

If the SCLK line is shared on two or more ICs, the IER flag will assert on all idle A1333 die (CS held high) after the first SPI transaction (on the bus), following power-up. This occurs independent of the 21-bit SPI packet. This spurious IER flag asserts, on the idle die, only during the first SPI transaction. All subsequent SPI transactions will process correctly. This spurious assertion will not affect any future reads or writes to the device while power is maintained. If the IC is programmed to validate the CRC on MOSI, a CRC error flag (Bit 10 of the WARN serial register) will also assert, related to the spurious detection of a bad SPI packet

Due to the initial assertion of the IER flag, it is recommended to clear all error and warning flags on all A1333 ICs following power-on (this is “good practice”, independent of the false IER flag assertion). By doing this, the false IER flag is cleared, preventing it from masking a real SPI communication issue.

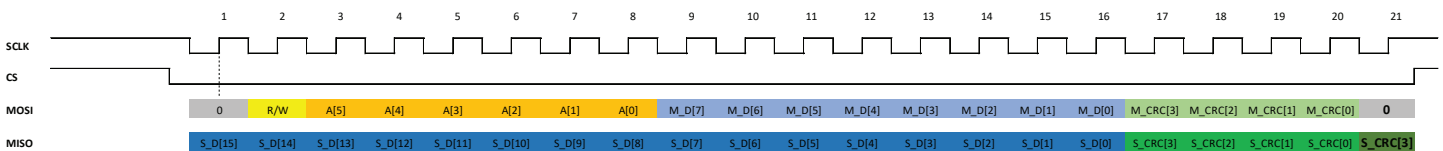

**Figure 66: 21-bit SPI Packet Format**

## Additional SPI Examples

The examples below show differing SPI implementations. All figures assume a shared SPI bus (MISO, MOSI, SCLK) between two sensors, with individual CS lines.

Figure 67 shows an example of pipelining SPI reads between two sensors, which can result in discarded packets or corrupted data when used with 16- or 17-bit SPI packets. In this example, SPI reads are bounced between Sensor 1 and Sensor 2, one frame at a time. During the interval in which the CS lines are high, the inoperative sensor will detect an incorrect number of edges, asserting the IER flag, and potentially corrupting the following read response.

Figure 68 is a modified version of the pipelining shown in Figure 67. The first read response from each sensor is known to be corrupt, and is ignored. Because of this, the second read request (which results in the first read response on the next sequence) can be a NOP command, resulting in all zeros from the device (a NOP command is a read of serial register 0x0, which is hard-

coded with all 0s). Inserting a NOP command between each valid read response ensures the data placed in the SPI buffers prior to the second response is valid.

It should be noted that the IER flag will assert on every change-over to a new die (CS line) when using this implementation due to the incorrect number of SCLK edges detected during the CS high period.

Figure 69 shows a 20-bit SPI packet. This removes the potential for incorrect read data (assuming the SCLK edge occurs 70 ns or later following the CS rising edge), allowing the two sensors to be addressed in a sequential manner, one frame per each sensor. This implementation has the added advantage of including a 4-bit CRC within each response. The IER flag may still assert when using a 20-bit packet.

Figure 70 shows implementation of a 21-bit SPI packet. This removes the false IER flag assertion and any potential for incorrect data interpretation. Allegro recommends using a 21-bit SPI packet when sharing SPI lines.

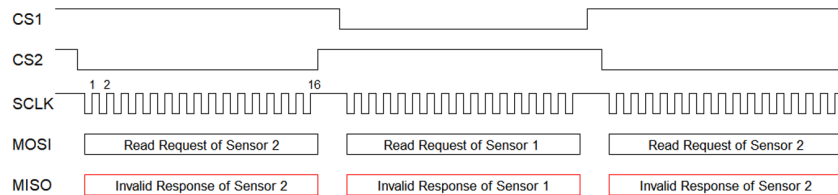

Figure 67: Implementation of SPI using 16- or 17-bit packets resulting in IER flag assertion and potentially corrupted data

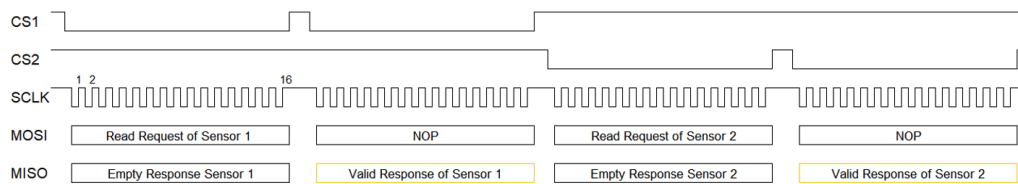

Figure 68: Implementation of SPI using 16- or 17-bit packets; valid data, IER flag will still assert

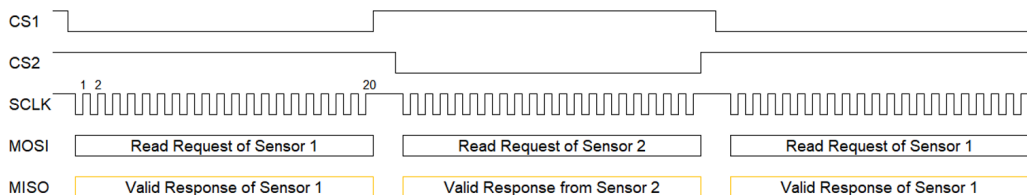

Figure 69: SPI Implementation using 20-bit packets; data contents are valid however IER flag may still assert

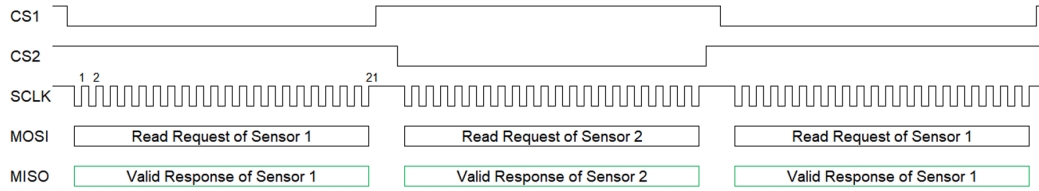

Figure 70: SPI Implementation using 21-bit packets; data contents are valid; no false IER flag generation

## Revision History

Number	Date	Description
–	September 25, 2017	Initial release
1	February 23, 2018	Updated Response Time value (p. 8), Typical Performance Characteristics section (p. 9-10), Figure 12 (p. 13), Figure 13 (p. 14), Device Programming Interfaces section (p. 26-42), Table 12 heading (p. 43), TCW[3] (page 52), Mag_Thresh_Hi and Mag_Thresh_Lo descriptions (p. 64), Table 15 (p. 66), Setting the Zero-Degree Position section (p. 70), Magnetic Target Requirements section (p. 70-71), I/O Structures (p. 73), and Package Outline Drawings active area depths (p. 74-75). Added 5 V interface voltage part variant, Manchester Interface Specifications (p. 7), Impact of High Speed Sensing section (p. 11-12). Removed CRC Documentation appendix.
2	August 1, 2018	Added A1333LLPTR-5-DD-T to Selection Guide (page 2).
3	October 15, 2018	Updated ASIL Status
4	November 1, 2019	Minor editorial updates
5	January 10, 2020	Updated Figure 1 (p. 1), Table of Contents (p. 3); Added SPI Frame Rate test condition (p. 6); Added Maximum Sourcing Current and Maximum Sinking Current characteristics (p. 7); Updated Response Time (p. 8), Figure 3 and 4 (p. 9); Added Figures 11 to 14 (p. 11-12); Updated Impact of High Speed Sensing section (p. 15); Added Measured Performance over RPM section (p. 15); Updated Figure 20 (p. 16), Figure 21 (p. 17); Added ABI Behavior at Power-Up section (p. 22); Updated Figure 29 (p. 23), Slew Rate Limiting for ABI section (p. 24); Added Effective Speed of Slew Time section (p. 24); Updated Brushless DC Motor Output section (p. 25-26); Added Spurious Interface Error (IER) When Sharing SPI Lines section (p. 30); Added 21-Bit SPI Packet section (p. 32); Updated Figure 53 (p. 40), Enabling EEPROM Access section (p. 41); Added EEPROM Margin Check section (p. 43-44); Updated INITIATE_SPECIAL description (p. 51), GAUSS description (p. 58), ABI_SLEW_TIME bit range (p. 64), ORATE (p. 68); Figure 56 and Table 20 (p. 75), Figure 63 (p. 80), Figure 64 (p. 81), Figure 65 (p. A-1), Angle Error equation (p. A-1); Added Appendix B (p. B-1 to B-4).
6	July 1, 2020	Updated LE-14 and LP-24 package drawing Hall element tolerances (p. 79-80)
7	October 8, 2020	Updated SPI Interface section (page 30)
8	February 1, 2021	Updated LE-14 package drawing (page 80).

Copyright 2021, Allegro MicroSystems.

Allegro MicroSystems reserves the right to make, from time to time, such departures from the detail specifications as may be required to permit improvements in the performance, reliability, or manufacturability of its products. Before placing an order, the user is cautioned to verify that the information being relied upon is current.

Allegro's products are not to be used in any devices or systems, including but not limited to life support devices or systems, in which a failure of Allegro's product can reasonably be expected to cause bodily harm.

The information included herein is believed to be accurate and reliable. However, Allegro MicroSystems assumes no responsibility for its use; nor for any infringement of patents or other rights of third parties which may result from its use.

Copies of this document are considered uncontrolled documents.

For the latest version of this document, visit our website:

[www.allegromicro.com](http://www.allegromicro.com)