

»Features

- Silicon technology
- Cannot be damaged by voltage
- Low capacitance
- Eliminate voltage overshoot
- Epoxy resin package
- Will not fatigue
- Complies with following standards:
 - GR1089
 - ITU K.20, K.21 and K.45
 - IEC 60950
 - UL 60950
 - TIA-968
- RoHS Compliant



SMB (DO-214AA)

»Mechanical Characteristics

- Package: SMB (3.67×5.4×2.3mm)
- Lead Finish: Matte Tin
- Case Material: "Green" Molding Compound.
- UL Flammability Classification Rating 94V-0
- Moisture Sensitivity: Level 1 per J-STD-020

»Applications

- COMMERCIAL SYSTEMS
- INDUSTRIAL & INSTRUMENTATION
- COMMUNICATIONS

»Marking Information



xxxC = Type Code
YYWW = Date Code

»Pin Configuration

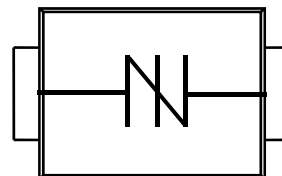

»Summary of Packing Options

Package	Packing Description	Packing Quantity	Industry Standard
SMB	Tape/Reel, 13" reel	3000	EIA-481-1
	Tape/Reel, 7" reel	500	EIA-481-1

» Absolute Maximum Ratings

Parameter	Symbol	Value	Units	Remarks
Peak Pulse Voltage	V_{PP}	6000	V	10/700us
Peak Pulse Current	I_{PP}	100	A	10/1000us
Peak Pulse Current	I_{PK}	400	A	8/20us
Peak One-cycle Surge Current	I_{TSM}	30	A	60Hz
Rate of Rise of Current	di/dt	500	A/us	
Typical Thermal Resistance Junction to Lead	$R_{\theta JL}$	20	°C/W	
Typical Thermal Resistance Junction to Ambient	$R_{\theta JA}$	100	°C/W	
Operating Temperature Range	T_J	-40 to 150	°C	
Storage Temperature Range	T_{STG}	-55 to 150	°C	

» Electrical Characteristics (TA=25°C unless otherwise noted)

Part Number	Marking	I_H mA MIN	V_S V 100KV/S MAX	I_{S_LMT} mA	V_T V @ I_T MAX	I_T A	I_D uA @ V_D MAX	V_D V	C_O pF 1MHz, 2V _{DC} TYP
BEP0080SC	E-8C	40	25	500	4	2.2	5	6	105
BEP0220SC	P02C	40	30	500	4	2.2	5	15	105
BEP0300SC	P03C	40	40	500	4	2.2	5	25	100
BEP0640SC	CP06C	120	77	800	4	2.2	5	58	95
BEP0720SC	P07C	120	88	800	4	2.2	5	65	95
BEP0900SC	P09C	120	98	800	4	2.2	5	75	95
BEP1100SC	P11C	120	130	800	4	2.2	5	90	90
BEP1300SC	P13C	120	160	800	4	2.2	5	120	90
BEP1500SC	P15C	120	180	800	4	2.2	5	140	85
BEP1800SC	P18C	120	220	800	4	2.2	5	170	80
BEP2300SC	P23C	120	260	800	4	2.2	5	190	75
BEP2600SC	P26C	120	300	800	4	2.2	5	220	70
BEP3100SC	P31C	120	350	800	4	2.2	5	275	65
BEP3500SC	P35C	120	400	800	4	2.2	5	320	60
BEP4500SC	P42C	120	550	800	4	2.2	5	400	45

»Rating And Characteristic Curves (TA=25°C unless otherwise noted)

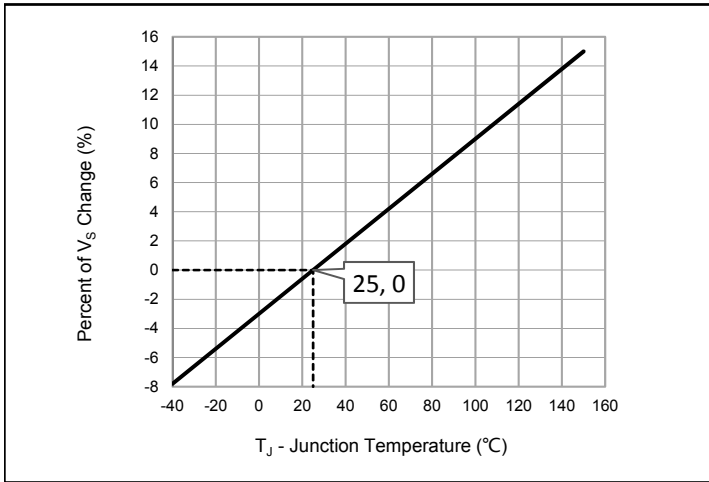

Fig. 1 - Peak Pulse Current Rating

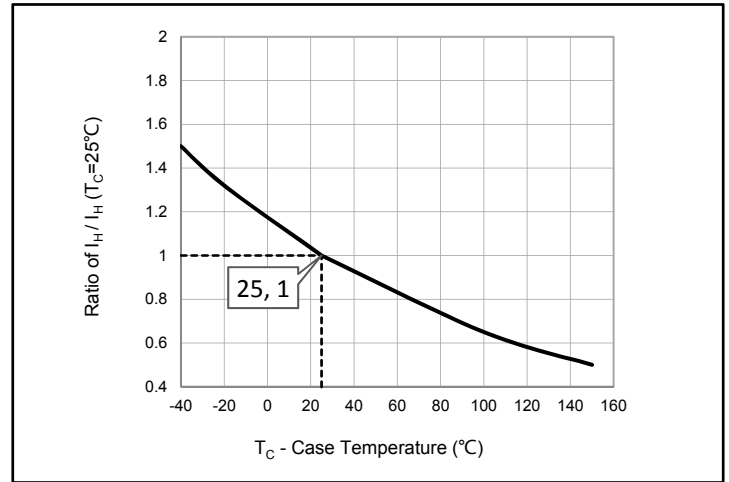

Fig. 2 - Normalized DC Holding Current vs. Case Temperature

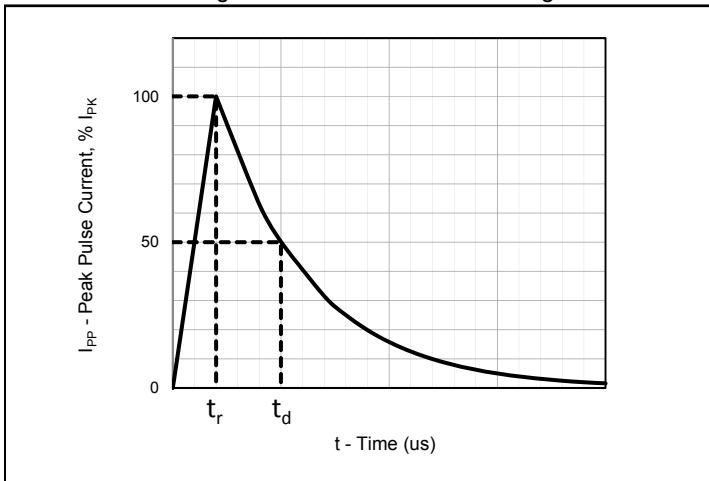

Fig. 3 - tr/td us Pulse Waveform

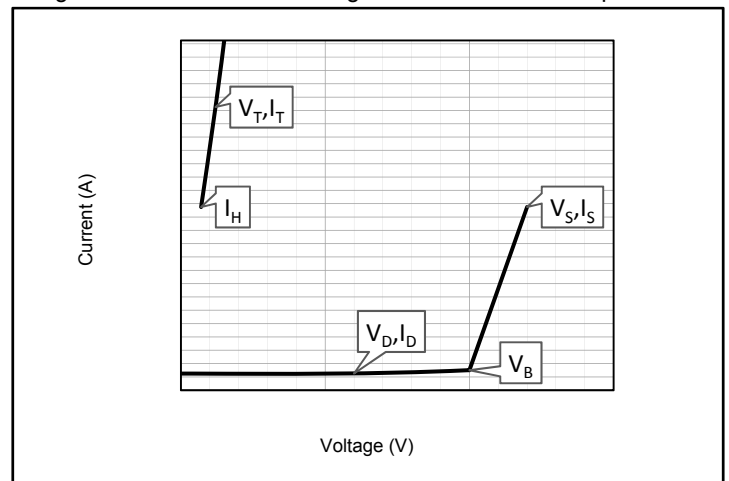

Fig. 4 - VI Curve

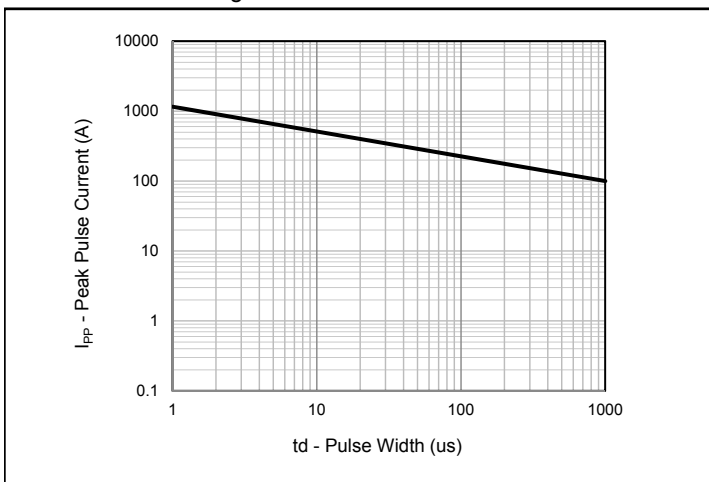

Fig. 5 - Peak Pulse Current Rating

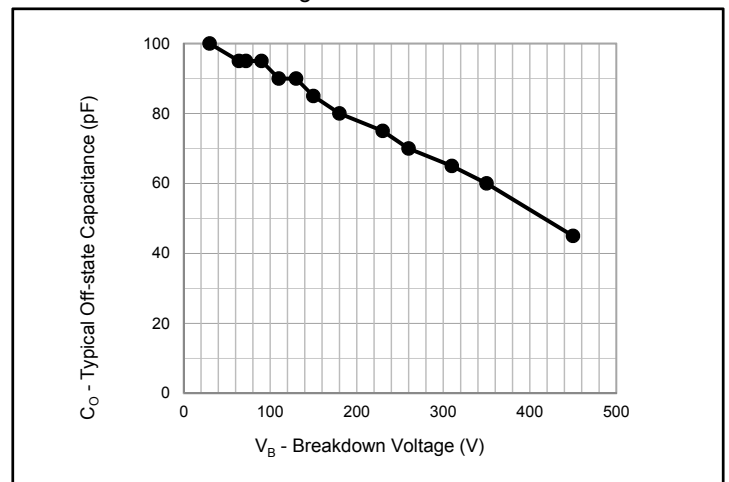
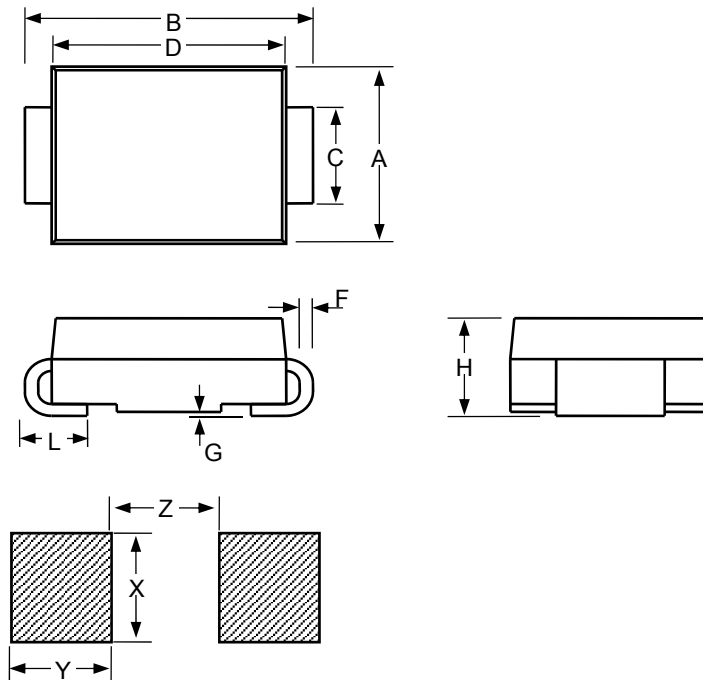

Fig. 6 - Typical Off-state Capacitance

» Package Dimensions



SMB						
Dimension	Inches			Millimeters		
	MIN	NOM	MAX	MIN	NOM	MAX
A	0.134	0.144	0.155	3.4	3.67	3.94
B	0.205	0.213	0.22	5.21	5.4	5.59
C	0.075	0.079	0.083	1.9	2	2.1
D	0.169		0.185	4.3		4.7
L	0.03		0.06	0.76		1.52
F	0.006		0.012	0.152		0.305
G	-		0.008	-		0.203
H	0.085	0.091	0.096	2.15	2.3	2.45
X		0.11			2.8	
Y		0.079			2	
Z		0.079			2	

» Soldering Parameters

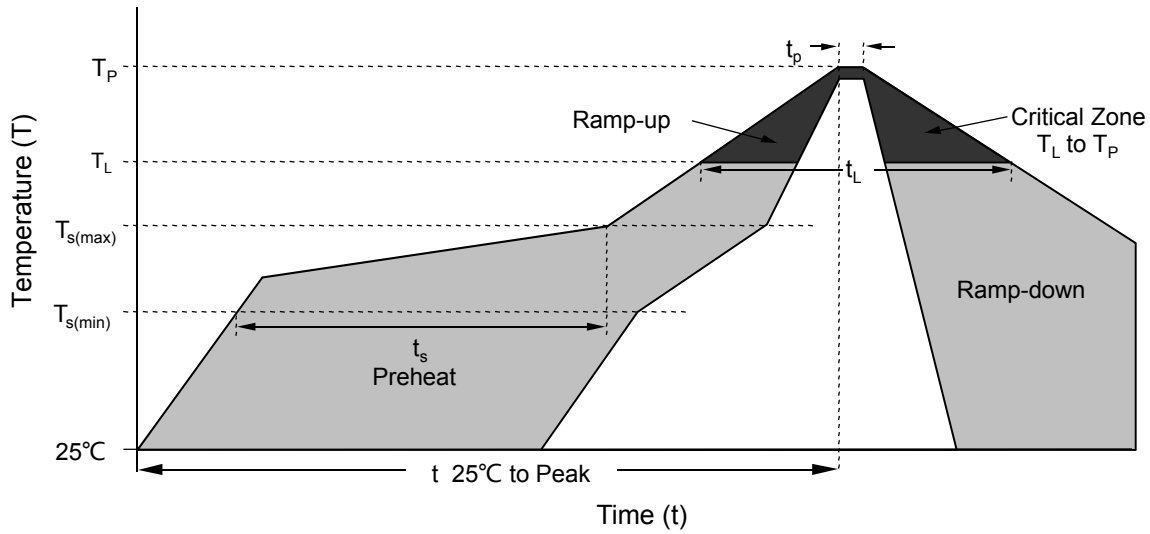

Reflow Condition		Lead-free assembly
Pre Heat	- Temperature Min ($T_{s(min)}$)	150°C
	- Temperature Max ($T_{s(max)}$)	200°C
	- Time (min to max) (t_s)	60 – 180 secs
Average ramp up rate (Liquidus Temp (T_L) to peak)		3°C/second max
$T_{s(max)}$ to T_L - Ramp-up Rate		3°C/second max
Reflow	- Temperature (T_L) (Liquidus)	217°C
	- Time (t_L)	60 – 150 secs
Peak Temperature (T_P)		260 ^{+0/-5} °C
Time within 5°C of actual peak Temperature (t_p)		20 – 40 secs
Ramp-down Rate		6°C/second max
Time 25°C to peak Temperature (t)		8 minutes Max.
Do not exceed		260°C

»Tape and Reel Specification

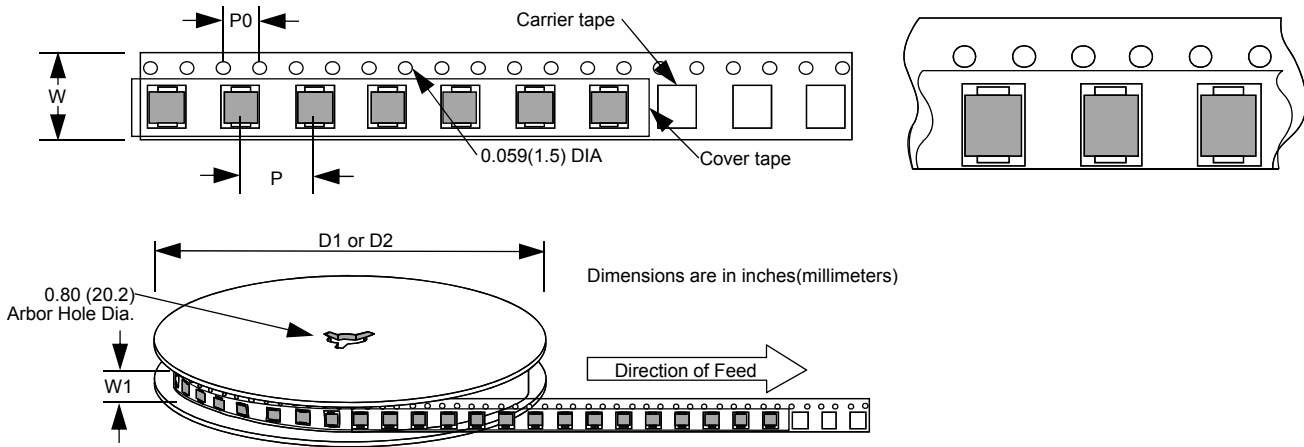

Dimension	Inches			Millimeters		
	MIN	NOM	MAX	MIN	NOM	MAX
P		0.315			8	
P0		0.157			4	
W		0.472			12	
W1		0.492			12.5	
D1		7			177.8	
D2		13			330.2	