



## 承认书

### Specification for approval

客户名称(Customer name): \_\_\_\_\_

经办者(Director): \_\_\_\_\_

职称(title): \_\_\_\_\_

客户料号(Customer part NO): \_\_\_\_\_

版本(Revision): \_\_\_\_\_ A.0

发件日期(Issue date): \_\_\_\_\_ 2018-12-06

回文日期(Return date): \_\_\_\_\_

一、谨致执事者：兹提供敝公司产品之有关详细规格及图面数据，敬请给予办理测试认定手续，同时敬请送返一份附有贵公司签认之测试认定后之样品认定书。

( We are please in sending you herewith our specification and drawings for your approval. )

( Please return to us one copy "For Approval" with your approved signatures. )

二、附件(Accessory):

- 样品    出货检验记录表    封装尺寸图    电气特性曲线  
内部线路图    焊性建议    PAD 建议    包装方式

三、客户意见栏(Customer's Proposal)

- 同意(Agree): (请于认可栏中签名)
- 不同意(Disagree):

原因(Reason): \_\_\_\_\_

客户认可签章(Customer Signature): \_\_\_\_\_

## 1. 产品描述/ Features

- 外观尺寸/ Package ( L/W/H ) : 1.6\*0.8\*0.6 mm
- 颜色/ Color: 白光 / White light
- 胶体/ Lens: 黄色平面胶体/ Yellow planar colloid
- EIA规范标准包装/ EIA STD Package
- 环保产品, 符合ROHS要求/ Meet ROHS, Green Product
- 适用于自动贴片机/ Compatible With SMT Automatic Equipment
- 适用于红外线回流焊制程/ Compatible With Infrared Reflow Solder Process

## 2. 外形尺寸及建议焊盘尺寸/ Package Profile & Soldering PAD Suggested

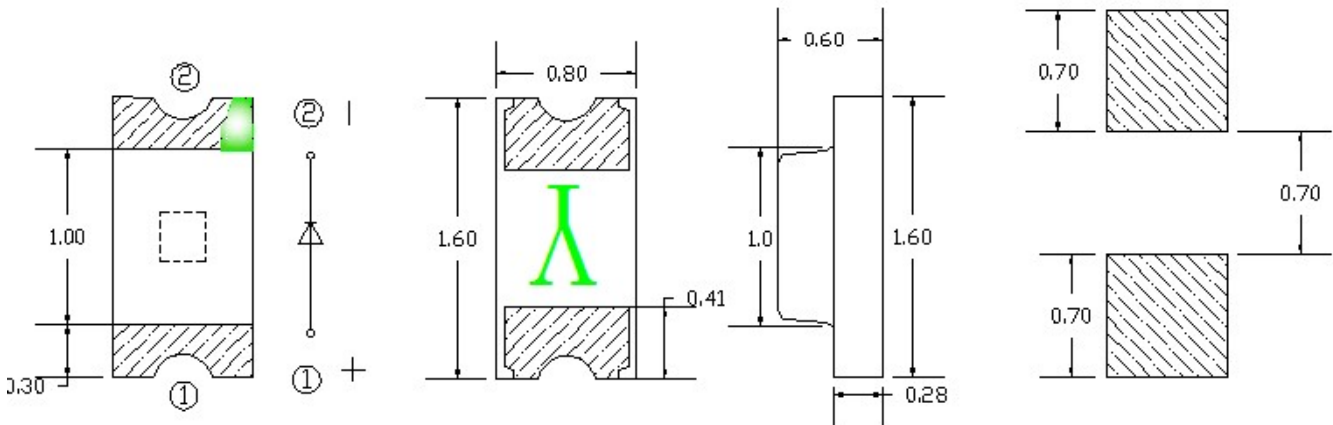

注/ Notes: 1. 单位 : 毫米 ( mm ) / All dimensions are in millimeters

2. 公差 : 如无特别标注则为 $\pm 0.1$  mm Tolerance is  $\pm 0.10$  mm unless otherwise noted

## 3. 建议焊接温度曲线 / Soldering Profile Suggested

lead-free solder

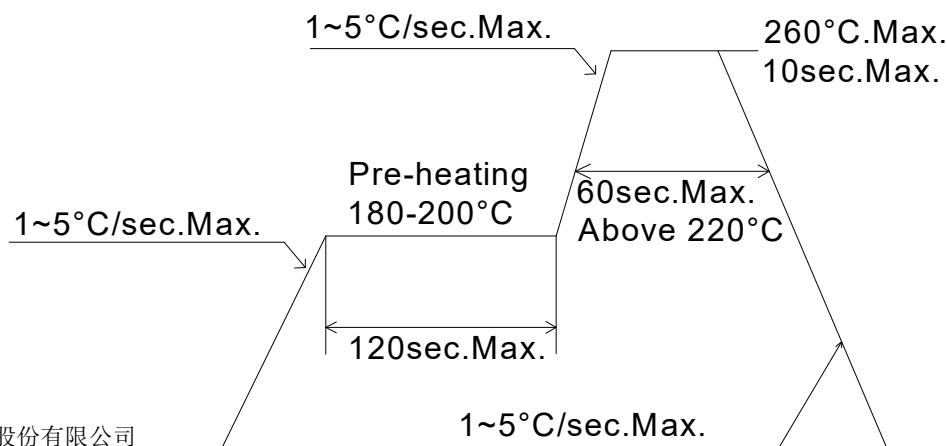



### 4. 最大绝对额定值/ Absolute Maximum Ratings (Ta=25°C)

参数/ Parameter	符号Symbol	最大额定值/ Rating	单位/ Unit
消耗功率/ Power Dissipation	Pd	100	mW
最大脉冲电流/ Peak Forward Current (1/10占空比, 0.1ms脉宽)	IFP	60	mA
正向直流工作电流/ DC Forward Current	IF	30	mA
反向电压/ Backward Voltage	VR	5	V
工作温度范围 Operating Temperature Range	Topr	-40°C ~ +85°C	
存储温度范围 Storage Temperature Range	Tstg	-40°C ~ +85°C	
焊接条件 Soldering Condition	Tsol	回流焊/ Reflow soldering : 260°C , 10s 手动焊/ Hand soldering : 300°C , 3s	
抗静电能力 Electrostatic Discharge	ESD		V

### 5. 光电参数/ Electrical Optical Characteristics (Ta=25°C)

参数 Parameter	符号 Symbol	最小值 Min.	代表值 Typ.	最大值 Max.	单位 Unit	测试条件 Test Condition
光强 Light Intensity	IV	210	--	520	mcd	IF = 5mA
半光强视角 Viewing Angle	2θ1/2	---	120	---	deg	IF = 5mA
色座标 CIE 1931 Coordinate	X	---	0.238	---		IF = 5mA
	Y	---	0.227	---		IF = 5mA
正向电压 Forward Voltage	VF	2.6		3.1	V	IF = 5mA
反向电压 Backward Voltage	IR	---	---	5	μA	VR = 5V



半波宽 Spectral Line Half-Width	$\Delta\lambda$		15		nm	IF = 5mA
色温 Color Temperature	CCT	19146		100000以上	K	IF = 5mA

## 6、光电参数分 BIN 规格/Photoelectric parameters are divided into BIN specifications

### 6.1.亮度分 BIN 规格/Brightness Bin specifications

Bin	Min	Max	Unit	Condition
P24	210	250	mcd	IF = 5mA
P25	250	300		
P26	300	360		
P27	360	430		
P28	430	520		

Notes: Tolerance of Luminous Intensity:  $\pm 10\%$

### 6.2.电压分 BIN 规格/ Voltage sub Bin specification

Bin	Min	Max	Unit	Condition
VM	2.6	2.7	V	IF = 5mA
VN	2.7	2.8		
VO	2.8	2.9		
VP	2.9	3.0		
VQ	3.0	3.1		

Notes: Tolerance of Forward Voltage:  $\pm 0.05V$

### 6.3、色区分 BIN 规格/Color distinguishes Bin specifications

新标准	X1	Y1	X2	Y2	X3	Y3	X4	Y4	色温 (K)
DT1	0.2085	0.1676	0.2174	0.1627	0.2227	0.1722	0.2139	0.1768	100000 以上
DT2	0.2139	0.1768	0.2227	0.1722	0.2281	0.1815	0.2193	0.1862	100000 以上
DT3	0.2193	0.1862	0.2281	0.1815	0.2333	0.1906	0.2247	0.1956	100000 以上
DT4	0.2247	0.1956	0.2333	0.1906	0.2388	0.2001	0.2301	0.205	100000 以上
DT5	0.2301	0.205	0.2388	0.2001	0.2442	0.2097	0.2355	0.2144	100000 以上
DT6	0.2355	0.2144	0.2442	0.2097	0.2495	0.2191	0.241	0.2238	77296-100000 以上
DT7	0.241	0.2238	0.2495	0.2191	0.2547	0.2284	0.2463	0.2331	40480-77296
DT8	0.2463	0.2331	0.2547	0.2284	0.2603	0.2376	0.2517	0.2424	26133-40480
DT9	0.2517	0.2424	0.2603	0.2376	0.2656	0.2469	0.2571	0.2517	19146-26133

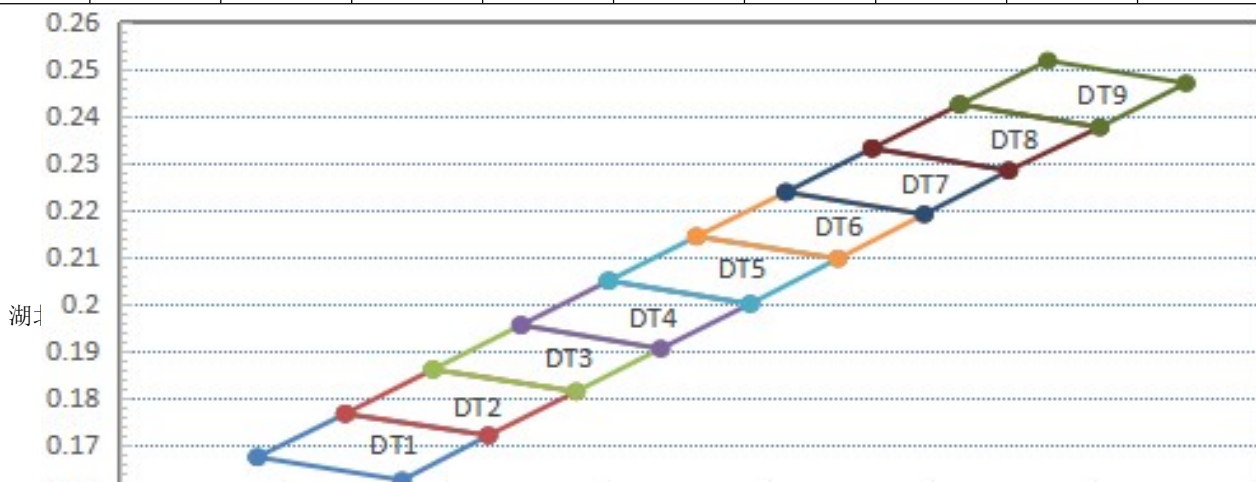



### 7、光电参数代表值特征曲线/ Typical Electrical-Optical Characteristics Curves

伏安特性曲线

Forward Current VS. Forward Voltage (Ta=25°C)

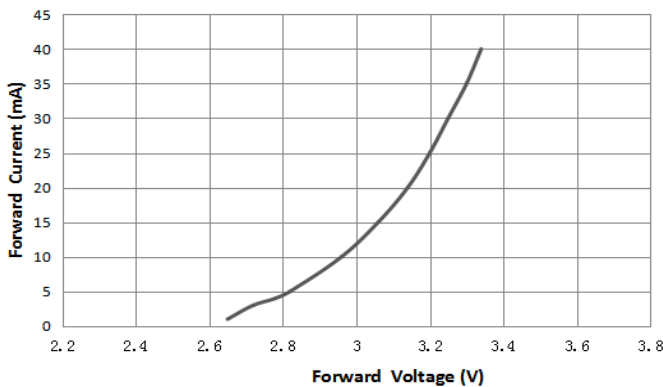

光谱分布特性曲线

Spectrum Distribution (Ta=25°C)

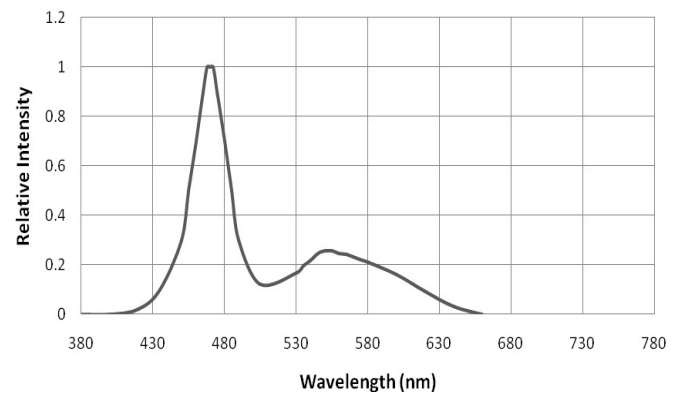

相对光强与环境温度特性曲线

Relative Intensity VS. Ambient Temperature (Ta=25°C)

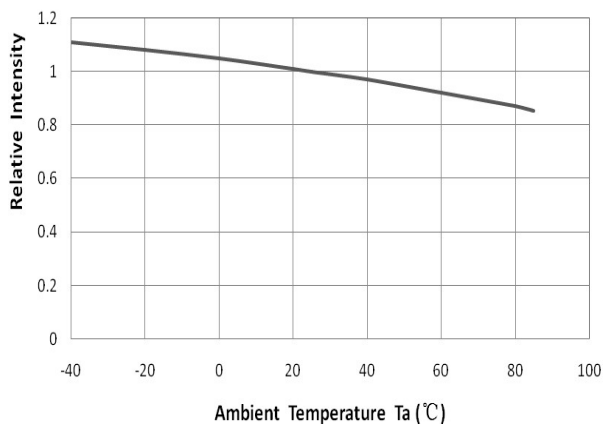

相对光强与电流特性曲线

Relative Intensity VS. Forward Current (Ta=25°C)

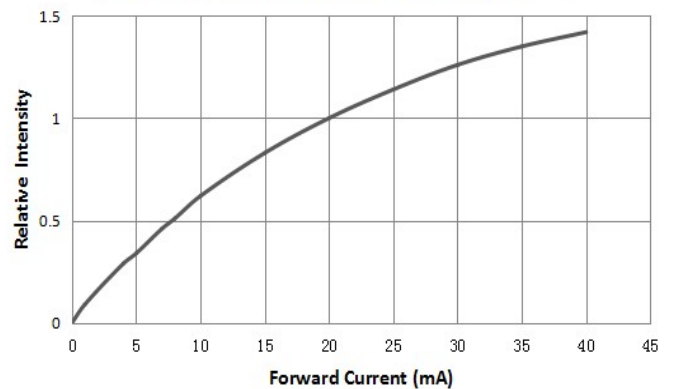

最大正向电流与环境温度特性曲线

Maximum Forward Current VS. Ambient temperature

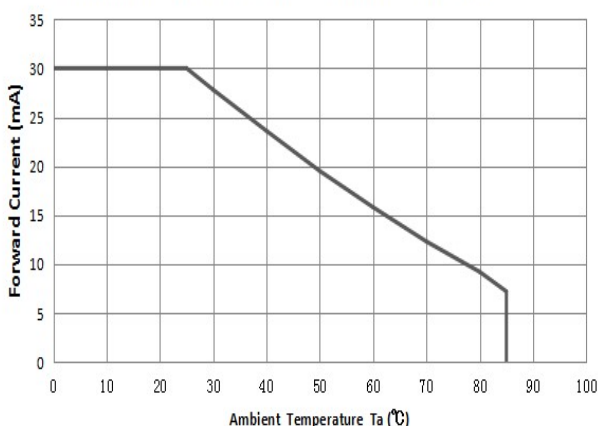

辐射特性曲线

Diagram characteristics of radiation

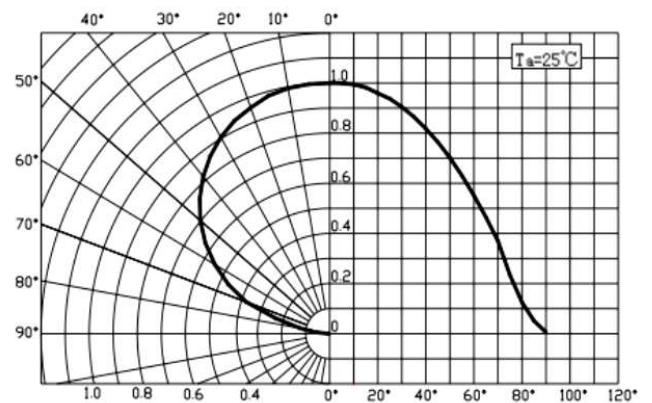

## 8. 包装载带与圆盘尺寸/ Reel And Tape Dimensions

包装数量: 4000 pcs/卷 Packing quantity: 4000 PCS/rolls

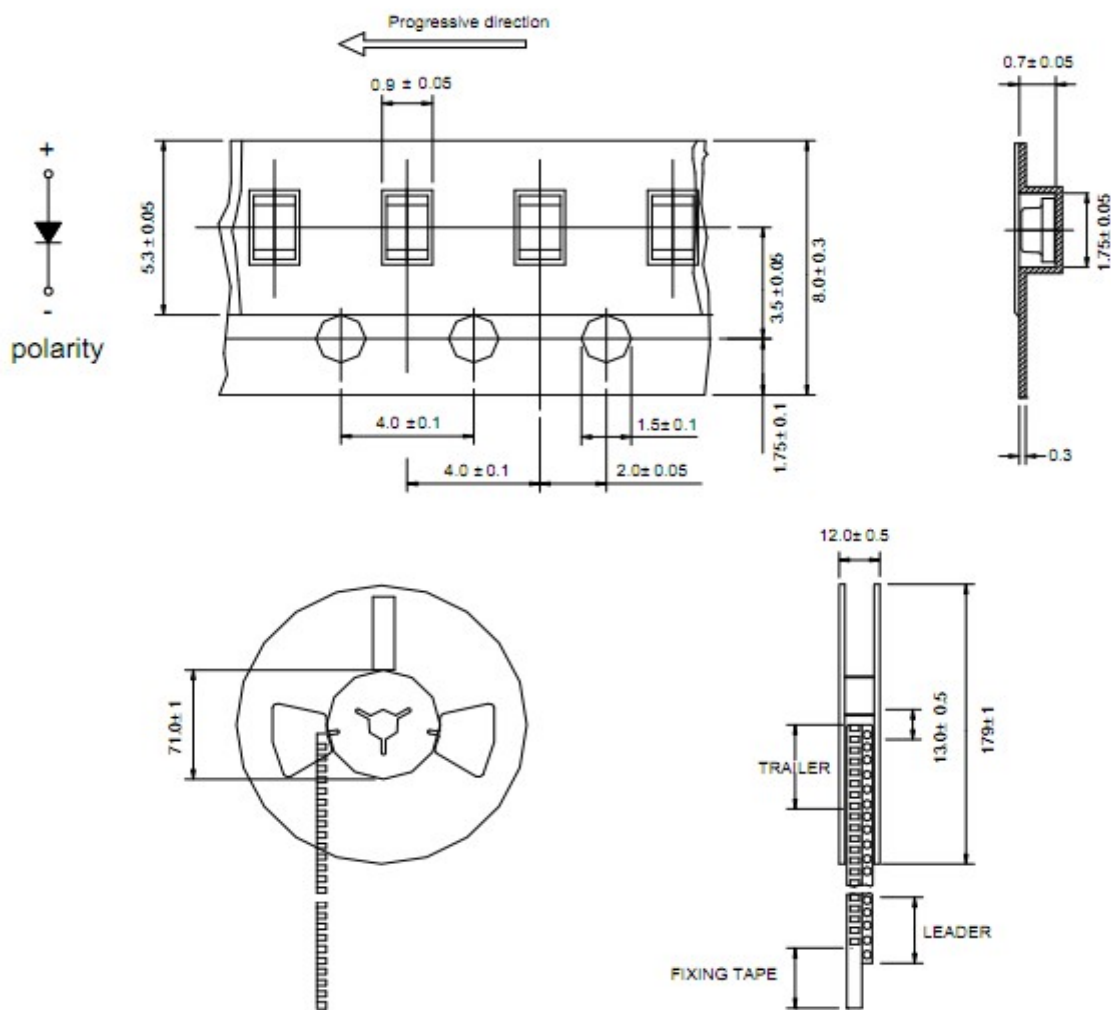

注/ Notes: 1. 尺寸单位为毫米(mm)/ All dimensions are in millimeters.

2. 尺寸公差是±0.1mm/ Tolerance is ± 0.1 mm unless otherwise noted.

## 9. 标签及标识/ Label Explanation:

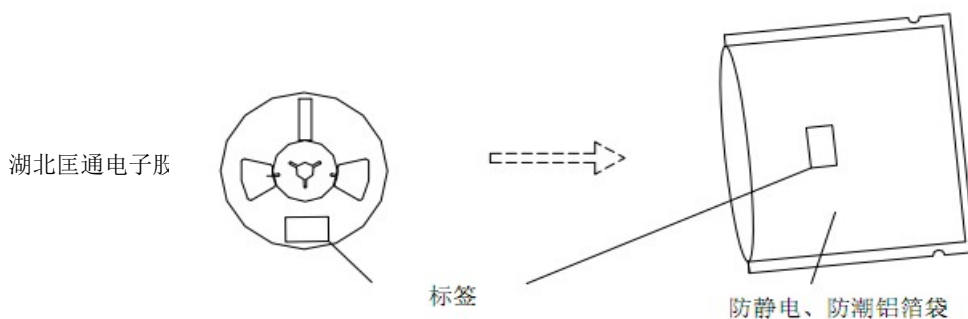



The label

Anti-static, moisture-proof aluminum foil bag

## 10. 信赖性测试项目及条件/Reliability Test Items And Conditions

测试项目 Test Item	Ref. Standard 参考标准	Test Condition 测试条件	Time 时间	Quantity 数量	Accepted/Rejected 接收/拒收
Reflow 回流焊	JESD22-B106	Temp:255°Cmax T=10 sec	2times	22	0/1
Thermal Shock 冷热冲击	JESD22-A106	-40°C 15min ↑ ↓ 100°C 15min	300 cycles	22	0/1
High Temperature Storage 高温保存	JESD22-A103	Temp:100°C	1000Hrs.	22	0/1
Low Temperature Storage 低温保存	JESD22-A119	Temp:-40°C	1000Hrs.	22	0/1
Life Test 常温通电	JESD22-A108	Ta=25°C IF=5mA	1000Hrs.	22	0/1

## 失效判定标准 Criteria For Judging Damage

Test Items 项目	Symbol 符号	Test Condition 测试条件	Judging For Damage 判定标准	
			Min. 最小	Max. 最大
Forward Voltage 正向电压	VF	IF=5mA	-	U.S.L*)x1.1
Reverse Current 漏电流	IR	VR = 5V	-	U.S.L*)x2.0
光强 Luminous Intensity	Mcd	IF=5mA	L.S.L*)x0.7	

U. S. L: Upper standard level 规格上限

L. S. L: Lower standard level 规格下限



备注 / Note

信赖性测试基于永裕现有的测试平台

The Reliability tests are based on YONGYU existing test platform

## 11. 注意事项/ Cautions:

### 11.1. 焊接/welding

11.1.1 SMD LED 灌封胶较软，外力易损坏发光面及塑料壳，焊接时要轻拿轻放。

SMD LED is soft and easy to damage the luminous surface and plastic shell by external force. It should be handled lightly when welding

11.1.2 建议使用易洗型的助焊剂，依照回流曲线条件回流焊接，回流次数最多两次，确保 LED 发光面干净，异物会影响发光颜色。

It is recommended to use soldering flux with tin wash type, reflow soldering according to the condition of reflux curve, reflow twice at most, ensure the LED luminous surface is clean, foreign matter will affect the luminous color.

11.1.3 只建议在修理和重工的情况下使用手工焊接；最高焊接温度不应超过 300 度，且须在 3 秒内完成（手工焊接只可焊接一次）烙铁最大功率应不超过 25W。

Manual welding is only recommended for repair and heavy industry;The maximum welding temperature should not exceed 300 degrees, and must be completed within 3 seconds (manual welding can only be welded once) soldering iron maximum power should not exceed 25W.

11.1.4 焊接过程中，严禁在高温情况下碰触胶体；焊接后，禁止对胶体施加外力，禁止弯折 PCB，避免元件受到撞击。

During the soldering process, do not touch the lens at high temperature, After soldering, any mechanical force on the lens or any excessive vibration shall not be accepted to apply, also the circuit board shall not be bent as well.

11.1.5 请不要将不同 BIN 级的 LED 使用于同一个产品上，否则可能会导致产品的严重色差。

Please do not use different BIN LED on the same product, otherwise it may cause serious color difference.

### 11.2. 清洗/cleaning

11.2.1 不能用超声波清洗，建议使用异丙醇（isopropyl alcohol）、纯酒精擦拭或浸渍（浸渍不超过 1 分钟）在室温下放置 15 分钟再使用；清洗后，确保 LED 发光面干净，异物会影响发光颜色。

/No ultrasonic cleaning. It is recommended to use isopropyl alcohol, pure alcohol to wipe or soak, not more than 1 minute, and leave at room temperature for 15 minutes before use.





After cleaning, make sure the LED luminous surface is clean and the foreign matter will affect the luminous color.

- 11.2.2 应避免接触或污染天那水,三氯乙烯、丙酮、硫化物、氮化物、酸、碱、盐类,这些物质会损伤LED。  
Avoid touching or contaminating the water, trichloroethylene, acetone, sulfide, nitride, acid, alkali, and salts that can damage leds.

### 11.3. 灌封/embedment

- 11.3.1 挥发性物质会渗透到LED内部,在通电产生光子及热的条件下,会导致LED变色,进而造成严重光衰,严禁使用任何对LED器件的性能或者可靠性有害的物质或材料,针对特定的用途和使用环境,建议对所有的物质和材料进行相容性的测试。在贴装LED时候,不要使用能产生有机挥发性气体的粘结剂。

Volatile substances to leach into the LED inside, photons in electricity and heat conditions, will lead to the LED color, thus causing serious droop, it is forbidden to use any of the LED device performance or reliability of harmful substances or materials, for a specific purpose and use of the environment, advice on all the material and the material compatibility test. When attaching LED, do not use adhesive that can produce volatile organic gas.

- 11.3.2 使用正常灌封胶时,建议先以少量试验,常温点亮168小时,确定没有问题再作业。

It is recommended to light up for 168 hours at room temperature for a small amount of test before using normal filling and sealing glue.

### 11.4. 保存/save

- 11.4.1 打开包装前,LED应存储在温度30℃或以下,相对湿度在RH60%以下,一年内使用。

Before opening the package, LED should be stored in a temperature 30 °C or below, under RH60 % relative humidity, used in a year.

- 11.4.2 LED是湿度敏感元件,为避免元件吸湿,打开包装后,LED应在温度30℃或以下,相对湿度在60%以内,使用时间7天。LED吸潮后,回流焊时可能裂胶,影响发光颜色。对于未使用的散件,请去潮处理(卷装品:烘烤60℃±5℃/24H;散装品:烘烤105℃±5℃/1H),然后再用铝箔袋密封后保存或者储存在氮气防潮柜内。

LED is humidity sensitive element, element to avoid moisture absorption, after open the packing, the LED should be in temperature 30 °C or below, within 60% relative humidity, using time 7 days. After moisture absorption, LED may crack when reflow soldering, influence the luminous color. For bulk is not used, please deal with the tide (for package product: bake 60 °C + / - 5 °C / 24 h. For bulk goods: baking 105 °C + 5 °C, 1 hours), and then save after sealed with aluminum foil bag or stored in nitrogen moistureproof enclosure

- 11.4.3 保存环境中避免有酸、碱以及腐蚀气体存在，同时避免强烈震动及强磁场作用。  
Avoid the presence of acid, alkali and corrosive gas in the preservation environment, and avoid strong vibration and strong magnetic field.

### 11.5. 静电/electrostatic

- 11.5.1 静电或峰值浪涌电压会损坏 LED,避免在开灯、关灯时产生瞬时电压。  
Static electricity or peak surge voltage will damage the LED, avoiding instantaneous voltage when the lamp is turned on or off.
- 11.5.2 建议使用 LED 时佩戴防静电手腕带,防静电手套,穿防静电鞋,使用的设备、仪器正确接地。LED 损坏后,表现出漏电流明显增加,低电流正向电压变低,低电流点不亮等现象。  
It is recommended to wear anti-static wrist bands, anti-static gloves and anti-static shoes when using LED. The equipment and instruments used are properly grounded. After the LED was damaged, the leakage current increased obviously, the forward voltage of low current became lower, and the low current point did not light, etc.

### 11.6 测试/test

- 11.6.1 LED 要在额定电流下驱动,同时电路中需要加限流电阻保护;否则,轻微的电压变化就会引起较大的电流变化,从而破坏 LED。  
LED shall be driven at rated current, and shall be protected by current-limiting resistance in the circuit. Otherwise, slight voltage changes will cause large current changes, which will damage the LED.
- 11.6.2 在电路导通或关闭情况下,要避免瞬间浪涌电压的产生,否则 LED 将被烧坏。  
When the circuit is on or off, avoid sudden surge voltage. Otherwise, the LED will be burnt out  
请参照下图示检测 LED:/Please check the LED as shown

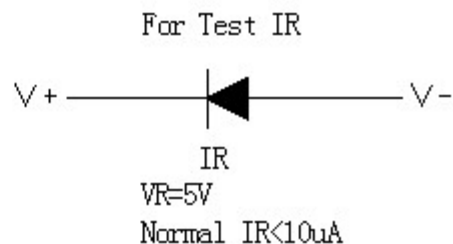
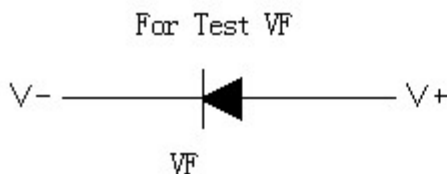

### 11.6.3 顺向电压 $V_F$ 过高或反向电压 $V_R$ 过高，均会损坏 LED.

If the forward voltage  $V_F$  is too high or the reverse voltage  $V_R$  is too high, the LED will be damaged.

### 11.6.4 点亮或测试 LED 时，加在 LED 两端的反向电压不得高于 5V，否则容易击伤 LED.

When lighting or testing the LED, the reverse voltage added on both ends of the LED shall not be higher than 5V, otherwise it is easy to damage the LED.

### 11.6.5 LED 发光颜色会随着工作电流不同而有少许变化,建议设计时考虑电阻与 LED 串联使用。

LED luminous color will vary slightly with the working current. It is suggested that resistance and LED should be used in series in the design

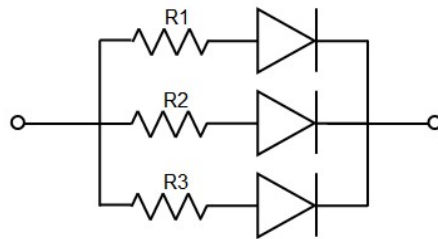

### 11.6.6 LED 容易因为自身的发热和环境的温度改变而改变，温度升高会降低 LED 发光效率，影响发光颜色在设计时应充分考虑散热问题。

LED is easy to change due to its own heat and changes in the temperature of the environment. The increase in temperature will reduce the luminous efficiency of LED, which will affect the luminous color. Heat dissipation should be fully considered in the design