

修改		标记	修改摘要	签名	日期
REV	NO	MARK	REVISION DESCRIPTION	SIGNATURE	DATE
			NEW DWG		2016-03-12

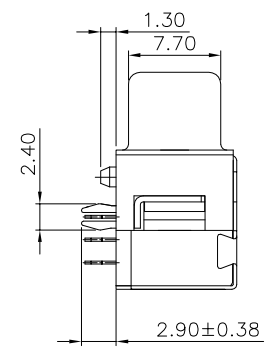
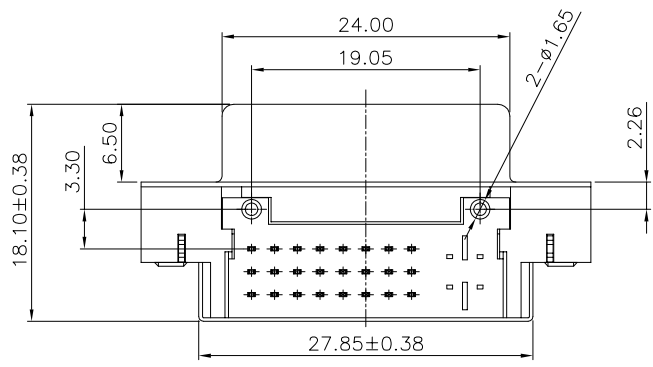
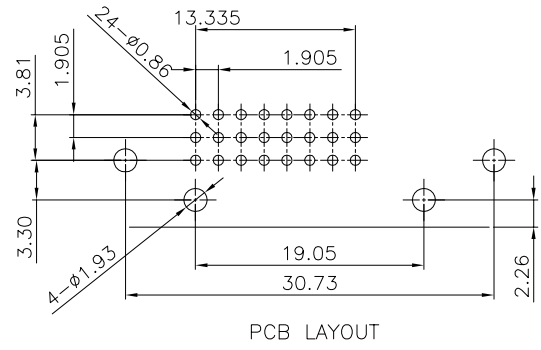
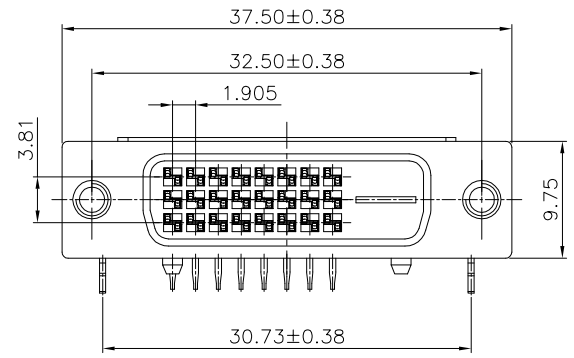

NOTE:

一、MATERIALS:

- Housing: SEE PART NO. Color: SEE PART NO.
- Cover: SEE PART NO. Color: SEE PART NO.
- Contacts: Brass
- Shell: SPCC
- Board Lock: SPCC
- Rivet: Copper Alloy
- Screw: SPCC Or Copper Alloy

二、FINISH:

- Contacts: Gold Plated on Contact Area
Sn Plated on Solderails
Nickel Under Plated Over All
- Shell: Nickel Plated
- Board Lock: Sn Plated
- Rivet: Nickel Plated
- Screw: Nickel Plated

		深圳市华德共创科技有限公司 Shenzhen Huade co-create Technology Co.,LTD 电话: 0755-23304126 传真: 0755-29940187						
		-TOLERANCES- UNLESS OTHERWISE SPECIFIED 公差参数表				TITLE: 产品名称: DVI24+1母座铆合不带螺丝带屏蔽壳		
X.X	±0.30	X.X*	±3°	APPD: 核准:	PART NO: 产品编号: DVI-HX-106DIP			
X.XX	±0.20	X.XX*	±2°	CHECK: 校对: 王建业	DATE	SCALE	UNIT	CODE NUMBER
X.XXX	±0.10	X.XXX*	±1°	DRAW: 绘图: 黄艳兰	2016-03-12	1:1	mm	A001