





# PhotoMOS 光可控硅 (SMD7/DIP7)

产品图片	Features 产品特性	Application 应用
 <b>DIP7</b>   <b>SMD7</b>	<ul style="list-style-type: none"> <li>●Contact Form 触点形式 1a (Zero-on 过零型)</li> <li>●Load Voltage 输出电压 110VAC/220VAC</li> <li>●Load Current 输出电流 0.9A、1.2A、2A</li> <li>●Low Off-State Leakage Current 漏电流 100μA</li> </ul>	<ul style="list-style-type: none"> <li>●Automatic Test Equipment 自动检测设备</li> <li>●Telephone Equipment 通信设备</li> <li>●Sensing Equipment 传感设备</li> <li>●Security Equipment 安全设备</li> <li>●I/O Modules I/O 模块</li> <li>●Modem 调制解调器</li> </ul>

## Type 种类

Output rating 输出额定		Marking model 标刻型号	Part No. 订货型号	
Load voltage 负载电压	Load current 负载电流		DIP 双列直插	SMD 表面贴装
110V/220V	0.9A	BC2213	BC2213	BC2213A
	1.2A	BC3213	BC3213	BC3213A
	2A	BC5213	BC5213	BC5213A

注：表示引脚类型的“A”未标刻在产品上，订货依据订货示例型号。

## Dimensions 外形尺寸

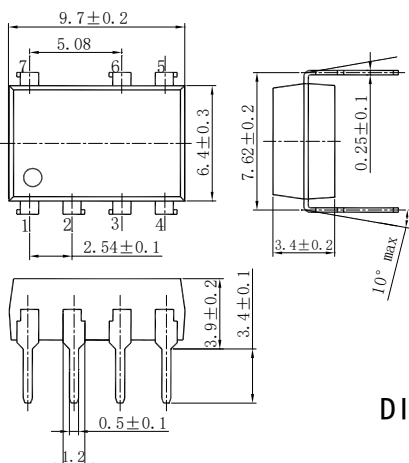

DIP7

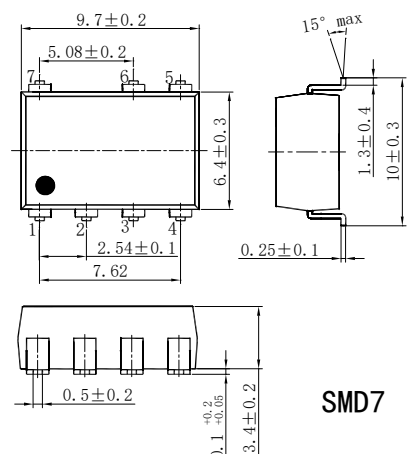

SMD7

## Terminal Identification 引脚标识

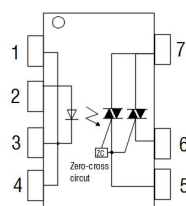

Zero-on 过零型

## Wiring Diagram 接线图

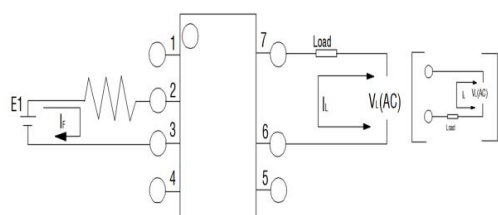

通讯地址：陕西省西安市国家民用航天产业基地航天中路385号众创广场11层1101.1102.1104室

生产地址：陕西省宝鸡市陈仓区群力路1号 邮政编码：721300

电话：(0917)-6293969 18609177833

传 真：(0917)-6293969



## Technical parameters 技术参数 (Ambient Temperature 25°C)

## I/O Absolute Maximum Ratings 输入输出电气参数最大值

Item 项目			Symbol 符号	BC2213	BC3213	BC5213
Operating Temperature 工作温度			$T_{OPR}$	-30°C~+85°C		
Storage Temperature 储存温度			$T_{STG}$	-40°C~+125°C		
Input 输入	Forward Current 输入电流	MAX. 最大值	$I_F$	50mA		
	Peak LED Current LED 峰值电流 (f=100Hz, Duty=1%)	MAX. 最大值	$I_{FP}$	1A		
	Reverse Voltage 反向电压	MIN. 最小值	$V_R$	5V		
Output 输出	Load Voltage 输出电压	MAX. 最大值	$V_L$	110VAC/220VAC		
	Repetitive peak OFF-state Voltage 瞬态电压	MAX. 最大值	$V_{DRM}$	600V		
	ON-state RMS Current 输出电流	MAX. 最大值	$I_{T(RMS)}$	0.9A	1.2A	2A
	Non-repetitive surge Current 浪涌电流	MAX. 最大值	$I_{TSM}$	9A	12A	20A
I/O Breakdown Voltage 输入输出间隔离电压		MAX. 最大值	$V_{iso}$	5000VAC		

## Electrical Specifications 输入输出电气参数

Item 项目			Symbol 符号	BC2213	BC3213	BC5213	Conditions 条件
Input 输入	Forward Voltage 正向电压	TYP. 典型值	$V_F$	1.18V			$I_F=10mA$
		MAX. 最大值		1.4V			
	Reverse Current 反向电流	MAX. 最大值	$I_R$	10 $\mu$ A			$V_R=5V$
Output 输出	Peak OFF-state current 漏电流峰	MAX. 最大值	$I_{DRM}$	100 $\mu$ A			$V_{DRM}=600V$
	ON-state Voltage 导通电压降	TYP. 典型值	$V_{TM}$	1.3V	1.1V	0.9V	$I_T=Rated$
		MAX. 最大值		2.3V			
		Holding Current 维持电流	MAX. 最大值	$I_H$	25mA		
	Rise rate of OFF-state Voltage 电压指数上升率	MIN. 最小值	dv/dt	200V/ $\mu$ S			$V_{DRM} = \frac{600}{\sqrt{2}} V$
		TYP. 典型值		1000V/ $\mu$ S			
	Recovery Input Voltage 恢复电压	MIN. 最小值	$V_{F OFF}$	0.5V			
Minimum Trigger Current 最小触发电流		TYP. 典型值	$I_{FT}$	2mA			$V_D=6V$
		MAX. 最大值		10mA			
	Turn-On Time 导通时间(Random-on)	MAX. 最大值	$T_{ON}$	10ms			$I=20mA$
	Turn-Off Time 关断时间	MAX. 最大值	$T_{OFF}$	10ms			
	I/O Insulation Resistance 绝缘电阻	MIN. 最小值	$R_{iso}$	50G $\Omega$			DC500V



# PhotoMOS 光可控硅 (SMD7/DIP7)

## Reference Data 参考数值 (BC2213/BC2223、BC3213/BC3223、BC5213/BC5223)

Load current Vs. Ambient temperature  
输出电流-环境温度曲线

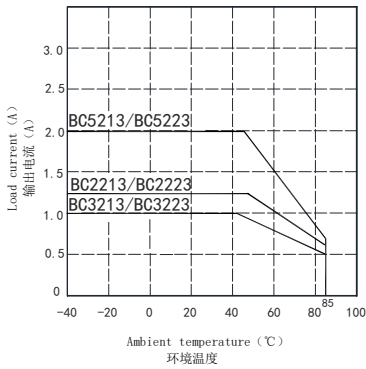

Forward current Vs. Ambient temperature  
输入电流-环境温度曲线

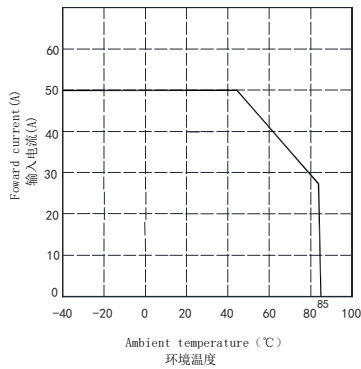

LED operate current Vs. Ambient temperature  
接通电流-环境温度曲线

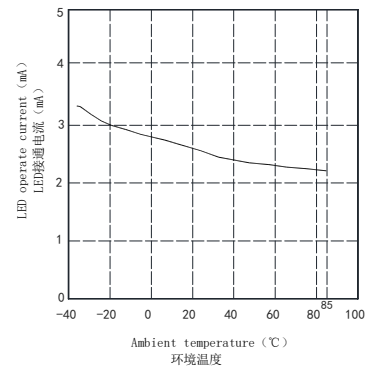

LED forward voltage Vs. Ambient temperature  
LED正向电压-环境温度曲线

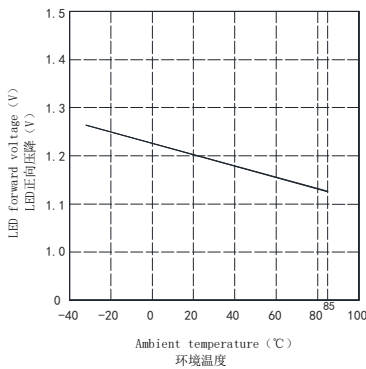

Turn on time Vs. Forward current  
导通时间-输入电流曲线

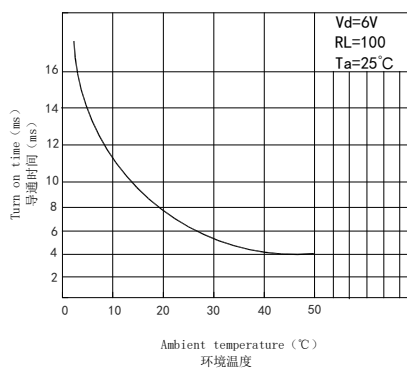

On-state voltage drop VS. Ambient Temperature  
输出导通电压降-环境温度曲线

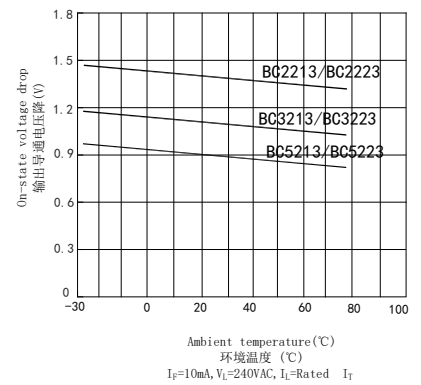

Forward current VS. Forward voltage  
输入电流-正向电压曲线

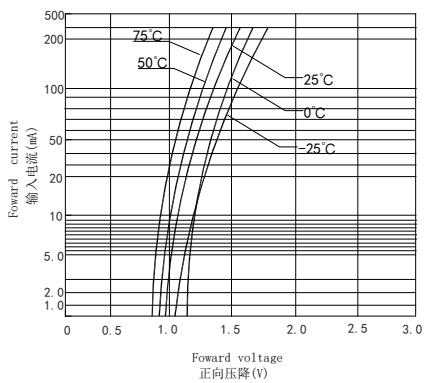

On-state load current VS. On-state voltage drop  
输出电流-导通电压降曲线

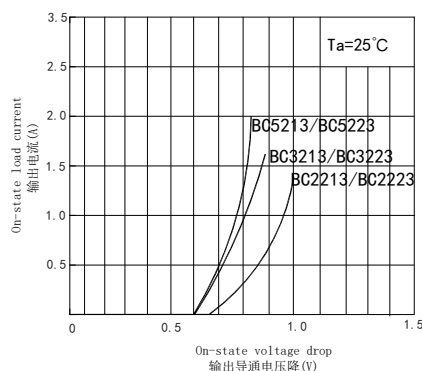

通讯地址: 陕西省西安市国家民用航天产业基地航天中路385号众创广场11层1101.1102.1104室

生产地址: 陕西省宝鸡市陈仓区群力路1号 邮政编码: 721300

电话: (0917)-6293969 18609177833

传 真: (0917)-6293969