





PhotoMOS 光可控硅 (SMD7/DIP7)

产品图片	Features 产品特性	Application 应用
 DIP7  SMD7	<ul style="list-style-type: none"> ●Contact Form 触点形式 1a (Zero-on 过零型) ●Load Voltage 输出电压 110VAC/220VAC ●Load Current 输出电流 0.9A、1.2A、2A ●Low Off-State Leakage Current 漏电流 100μA 	<ul style="list-style-type: none"> ●Automatic Test Equipment 自动检测设备 ●Telephone Equipment 通信设备 ●Sensing Equipment 传感设备 ●Security Equipment 安全设备 ●I/O Modules I/O 模块 ●Modem 调制解调器

Type 种类

Output rating 输出额定		Marking model 标刻型号	Part No. 订货型号	
Load voltage 负载电压	Load current 负载电流		DIP 双列直插	SMD 表面贴装
110V/220V	0.9A	BC2213	BC2213	BC2213A
	1.2A	BC3213	BC3213	BC3213A
	2A	BC5213	BC5213	BC5213A

注：表示引脚类型的“A”未标刻在产品上，订货依据订货示例型号。

Dimensions 外形尺寸

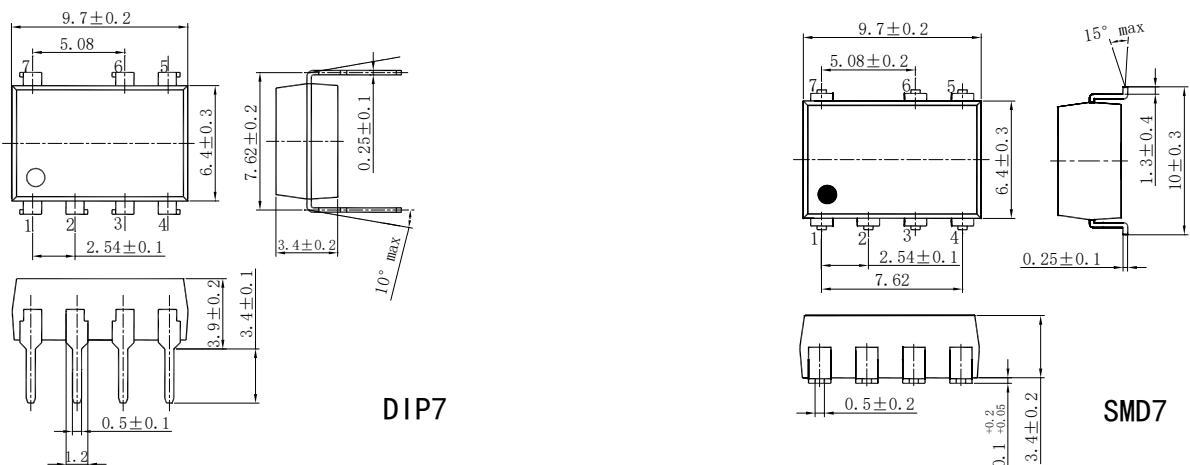

Terminal Identification 引脚标识

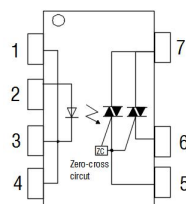

Zero-on 过零型

Wiring Diagram 接线图

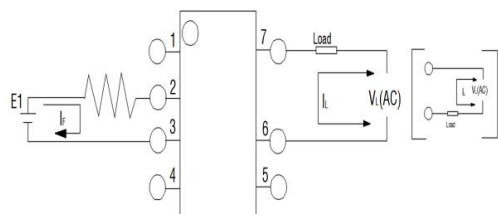

通讯地址：陕西省西安市国家民用航天产业基地航天中路385号众创广场11层1101.1102.1104室

生产地址：陕西省宝鸡市陈仓区群力路1号 邮政编码：721300

电话：(0917)-6293969 18609177833

传 真：(0917)-6293969



Technical parameters 技术参数 (Ambient Temperature 25°C)

I/O Absolute Maximum Ratings 输入输出电气参数最大值

Item 项目	Symbol 符号	BC2213	BC3213	BC5213	
Operating Temperature 工作温度	T_{OPR}	-30°C~+85°C			
Storage Temperature 储存温度	T_{STG}	-40°C~+125°C			
Input 输入	Forward Current 输入电流	MAX. 最大值	I_F 50mA		
	Peak LED Current LED 峰值电流 (f=100Hz, Duty=1%)	MAX. 最大值	I_{FP} 1A		
	Reverse Voltage 反向电压	MIN. 最小值	V_R 5V		
Output 输出	Load Voltage 输出电压	MAX. 最大值	V_L 110VAC/220VAC		
	Repetitive peak OFF-state Voltage 瞬态电压	MAX. 最大值	V_{DRM} 600V		
	ON-state RMS Current 输出电流	MAX. 最大值	$I_{T(RMS)}$ 0.9A	1.2A	2A
	Non-repetitive surge Current 浪涌电流	MAX. 最大值	I_{TSM} 9A	12A	20A
I/O Breakdown Voltage 输入输出间隔离电压	MAX. 最大值	V_{iso}	5000VAC		

Electrical Specifications 输入输出电气参数

Item 项目	Symbol 符号	BC2213	BC3213	BC5213	Conditions 条件	
Input 输入	Forward Voltage 正向电压	TYP. 典型值	1.18V			$I_F=10mA$
		MAX. 最大值	1.4V			
	Reverse Current 反向电流	MAX. 最大值	I_R 10 μ A			$V_R=5V$
Output 输出	Peak OFF-state current 漏电流峰	MAX. 最大值	I_{DRM} 100 μ A			$V_{DRM}=600V$
	ON-state Voltage 导通电压降	TYP. 典型值	1.3V	1.1V	0.9V	$I_T=Rated$
		MAX. 最大值	2.3V			
	Holding Current 维持电流	MAX. 最大值	I_H 25mA			$V_D=6V$
Rise rate of OFF-state 电压指数上升率	MIN. 最小值	200V/ μ S			$V_{DRM} = \frac{600}{\sqrt{2}} V$	
	TYP. 典型值	1000V/ μ S				
Recovery Input Voltage 恢复电压	MIN. 最小值	$V_{F OFF}$	0.5V			
Minimum Trigger Current 最小触发电流	TYP. 典型值	I_{FT} 2mA			$V_D=6V$	
	MAX. 最大值	10mA				
Turn-On Time 导通时间(Random-on)	MAX. 最大值	T_{ON}	10ms			$I=20mA$
Turn-Off Time 关断时间	MAX. 最大值	T_{OFF}	10ms			
I/O Insulation Resistance 绝缘电阻	MIN. 最小值	R_{iso}	50G Ω			DC500V



PhotoMOS 光可控硅 (SMD7/DIP7)

Reference Data 参考数值 (BC2213/BC2223、BC3213/BC3223、BC5213/BC5223)

Load current Vs. Ambient temperature
输出电流-环境温度曲线

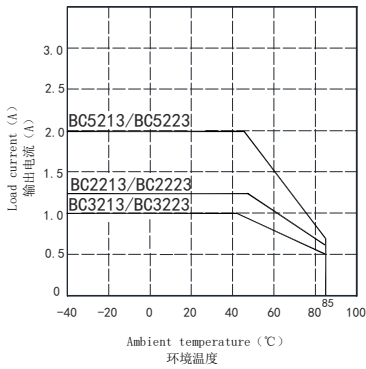

Forward current Vs. Ambient temperature
输入电流-环境温度曲线

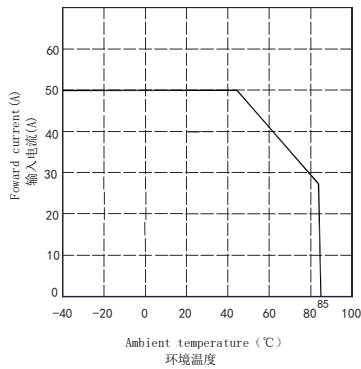

LED operate current Vs. Ambient temperature
接通电流-环境温度曲线

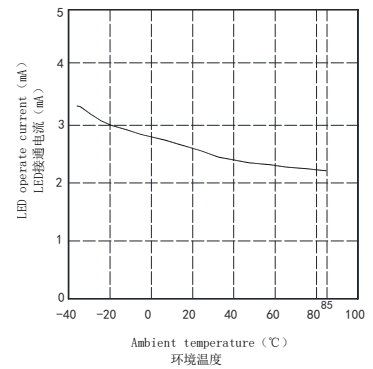

LED forward voltage Vs. Ambient temperature
LED正向电压-环境温度曲线

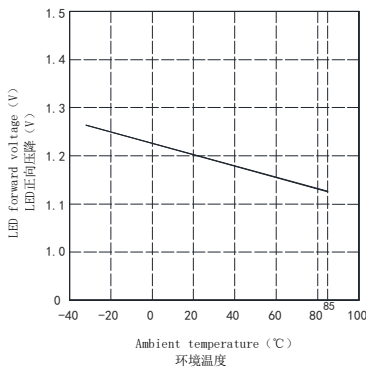

Turn on time Vs. Forward current
导通时间-输入电流曲线

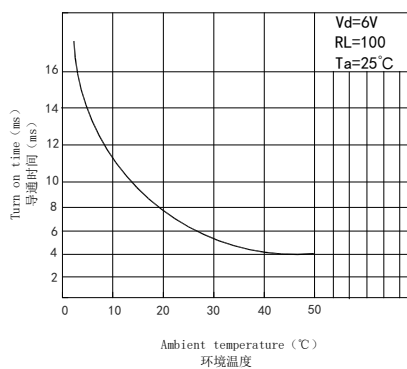

On-state voltage drop VS. Ambient Temperature
输出导通电压降-环境温度曲线

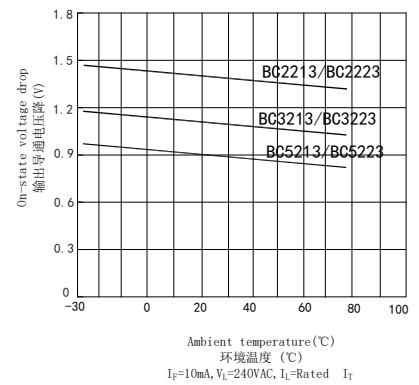

Forward current VS. Forward voltage
输入电流-正向电压曲线

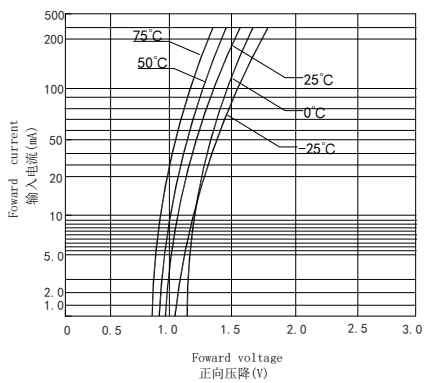

On-state load current VS. On-state voltage drop
输出电流-导通电压降曲线

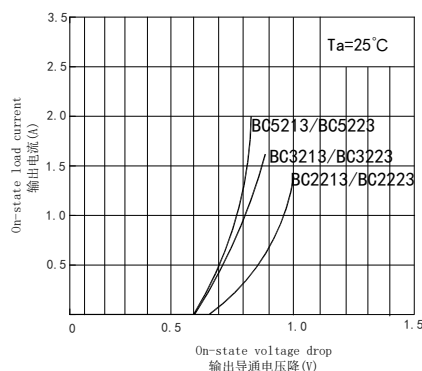

通讯地址: 陕西省西安市国家民用航天产业基地航天中路385号众创广场11层1101.1102.1104室

生产地址: 陕西省宝鸡市陈仓区群力路1号 邮政编码: 721300

电话: (0917)-6293969 18609177833

传 真: (0917)-6293969