



Features

- High Speed Switching with Low Capacitances
- High Blocking Voltage with Low $R_{DS(on)}$
- Easy to Parallel and Simple to Drive
- Ultra-low Drain-gate capacitance
- Halogen Free, RoHS Compliant

Benefits

- Higher System Efficiency
- Increased System Switching Frequency
- Reduced Cooling Requirements
- Increased System Reliability

Applications

- Auxiliary Power Supplies
- Switch Mode Power Supplies
- High-voltage Capacitive Loads

V_{DS}	1700 V
$I_D @ 25^\circ\text{C}$	5.0 A
$R_{DS(on)}$	1.0 Ω

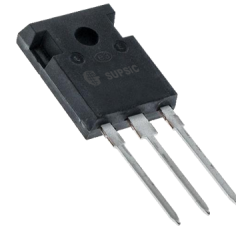

TO-247-3

Package

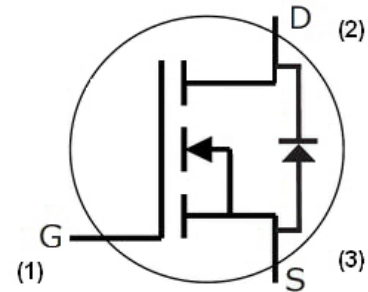

Part Number	Package	Marking
GC2M1000170D	TO-247-3	GC2M1000170

Maximum Ratings ($T_c = 25^\circ\text{C}$ unless otherwise specified)

Symbol	Parameter	Value	Unit	Test Conditions	Note
V_{DSmax}	Drain - Source Voltage	1700	V	$V_{GS} = 0\text{ V}, I_D = 100\ \mu\text{A}$	
V_{GSmax}	Gate - Source Voltage	-10/+25	V	Absolute maximum values	
V_{GSop}	Gate - Source Voltage	-5/+20	V	Recommended operational values	
I_D	Continuous Drain Current	5.0	A	$V_{GS} = 20\text{ V}, T_C = 25^\circ\text{C}$	Fig. 19
		3.5		$V_{GS} = 20\text{ V}, T_C = 100^\circ\text{C}$	
$I_{D(pulse)}$	Pulsed Drain Current	15	A	Pulse width t_p limited by T_{jmax}	Fig. 22
P_D	Power Dissipation	69	W	$T_c=25^\circ\text{C}, T_j = 150^\circ\text{C}$	Fig. 20
T_j, T_{stg}	Operating Junction and Storage Temperature	-55 to +150	$^\circ\text{C}$		
T_L	Solder Temperature	260	$^\circ\text{C}$	1.6mm (0.063") from case for 10s	
M_d	Mounting Torque	1 8.8	Nm lbf-in	M3 or 6-32 screw	

Electrical Characteristics ($T_c = 25^\circ\text{C}$ unless otherwise specified)

Symbol	Parameter	Min.	Typ.	Max.	Unit	Test Conditions	Note
$V_{(BR)DSS}$	Drain-Source Breakdown Voltage	1700			V	$V_{GS} = 0\text{ V}, I_D = 100\ \mu\text{A}$	
$V_{GS(th)}$	Gate Threshold Voltage	2.0	2.8	4	V	$V_{DS} = V_{GS}, I_D = 0.5\ \text{mA}$	Fig. 11
			2.4		V	$V_{DS} = V_{GS}, I_D = 0.5\ \text{mA}, T_J = 150^\circ\text{C}$	
I_{DSS}	Zero Gate Voltage Drain Current		1	100	μA	$V_{DS} = 1.7\ \text{kV}, V_{GS} = 0\ \text{V}$	
I_{GSS}	Gate-Source Leakage Current			250	nA	$V_{GS} = 20\ \text{V}, V_{DS} = 0\ \text{V}$	
$R_{DS(on)}$	Drain-Source On-State Resistance		0.80	1.4	Ω	$V_{GS} = 20\ \text{V}, I_D = 2\ \text{A}$	Fig. 4,5,6
			1.4			$V_{GS} = 20\ \text{V}, I_D = 2\ \text{A}, T_J = 150^\circ\text{C}$	
g_{fs}	Transconductance		1.04		S	$V_{DS} = 20\ \text{V}, I_{DS} = 2\ \text{A}$	Fig. 7
			1.09			$V_{DS} = 20\ \text{V}, I_{DS} = 2\ \text{A}, T_J = 150^\circ\text{C}$	
C_{iss}	Input Capacitance		215		pF	$V_{GS} = 0\ \text{V}$ $V_{DS} = 1000\ \text{V}$ $f = 1\ \text{MHz}$	Fig. 17,18
C_{oss}	Output Capacitance		19				
C_{rss}	Reverse Transfer Capacitance		2.2				
E_{oss}	C_{oss} Stored Energy		10.2		μJ	$V_{AC} = 25\ \text{mV}$	Fig. 16
E_{ON}	Turn-On Switching Energy		89		μJ	$V_{DS} = 1.2\ \text{kV}, V_{GS} = -5/20\ \text{V}$ $I_D = 2\ \text{A}, R_{G(ext)} = 2.5\ \Omega,$ $L = 1478\ \mu\text{H}, T_J = 150^\circ\text{C}$	Fig. 26
E_{OFF}	Turn Off Switching Energy		14				
$t_{d(on)}$	Turn-On Delay Time		5		ns	$V_{DD} = 1.2\ \text{kV}, V_{GS} = -5/20\ \text{V}$ $I_D = 2\ \text{A}, R_{G(ext)} = 2.5\ \Omega, R_L = 600\ \Omega$ Timing relative to V_{DS} Per IEC60747-8-4 pg 83	Fig. 27
t_r	Rise Time		19				
$t_{d(off)}$	Turn-Off Delay Time		14				
t_f	Fall Time		63				
$R_{G(int)}$	Internal Gate Resistance		24.8		Ω	$f = 1\ \text{MHz}, V_{AC} = 25\ \text{mV}$	
Q_{gs}	Gate to Source Charge		4		nC	$V_{DS} = 1.2\ \text{kV}, V_{GS} = -5/20\ \text{V}$ $I_D = 2\ \text{A}$ Per IEC60747-8-4 pg 21	Fig. 12
Q_{gd}	Gate to Drain Charge		12				
Q_g	Total Gate Charge		22				

Reverse Diode Characteristics

Symbol	Parameter	Typ.	Max.	Unit	Test Conditions	Note
V_{SD}	Diode Forward Voltage	3.8		V	$V_{GS} = -5\ \text{V}, I_{SD} = 1\ \text{A}, T_J = 25^\circ\text{C}$	Fig. 8, 9, 10
		3.3		V	$V_{GS} = -5\ \text{V}, I_{SD} = 1\ \text{A}, T_J = 150^\circ\text{C}$	
I_S	Continuous Diode Forward Current		4	A	$T_c = 25^\circ\text{C}$	Note 1
t_{rr}	Reverse Recovery Time	30		ns	$V_{GS} = -5\ \text{V}, I_{SD} = 2\ \text{A}, T_J = 150^\circ\text{C}$ $V_R = 1.2\ \text{kV}$ $dif/dt = 1135\ \text{A}/\mu\text{s}$	Note 1
Q_{rr}	Reverse Recovery Charge	31		nC		
I_{rrm}	Peak Reverse Recovery Current	3		A		

Note (1): When using SiC Body Diode the maximum recommended $V_{GS} = -5\text{V}$

Thermal Characteristics

Symbol	Parameter	Typ.	Max.	Unit	Test Conditions	Note
$R_{\theta JC}$	Thermal Resistance from Junction to Case	1.7	1.8	$^\circ\text{C}/\text{W}$		Fig. 21
$R_{\theta JA}$	Thermal Resistance from Junction to Ambient		40			

Typical Performance

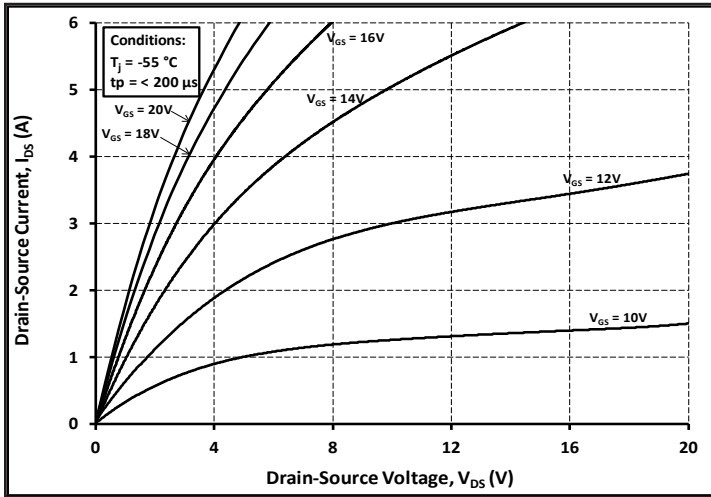

Figure 1. Output Characteristics $T_j = -55\text{ }^\circ\text{C}$

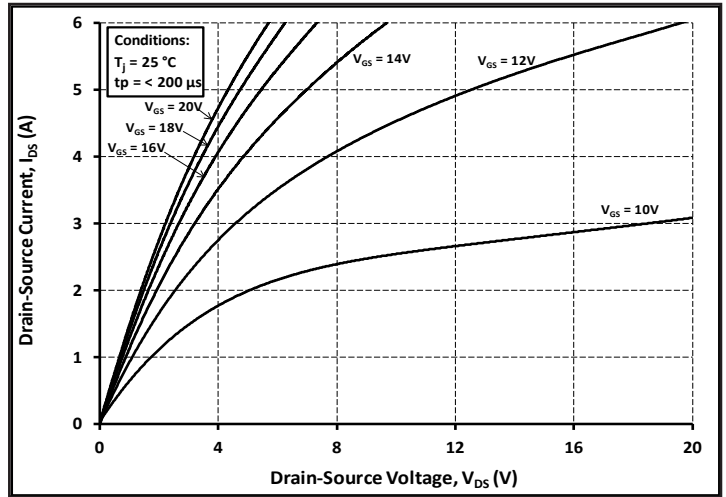

Figure 2. Output Characteristics $T_j = 25\text{ }^\circ\text{C}$

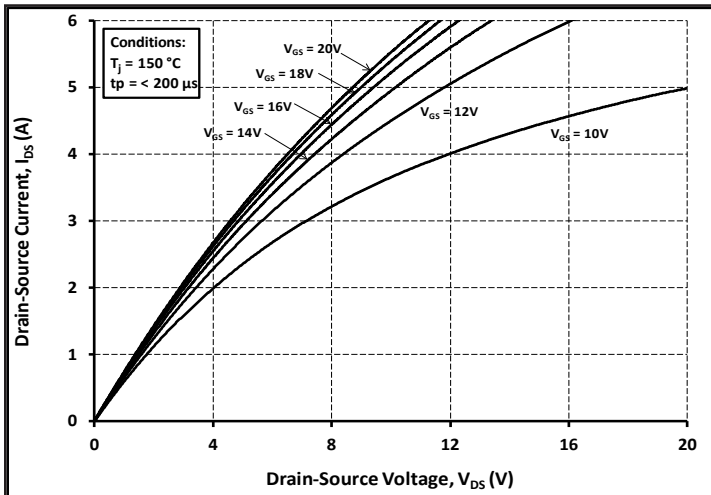

Figure 3. Output Characteristics $T_j = 150\text{ }^\circ\text{C}$

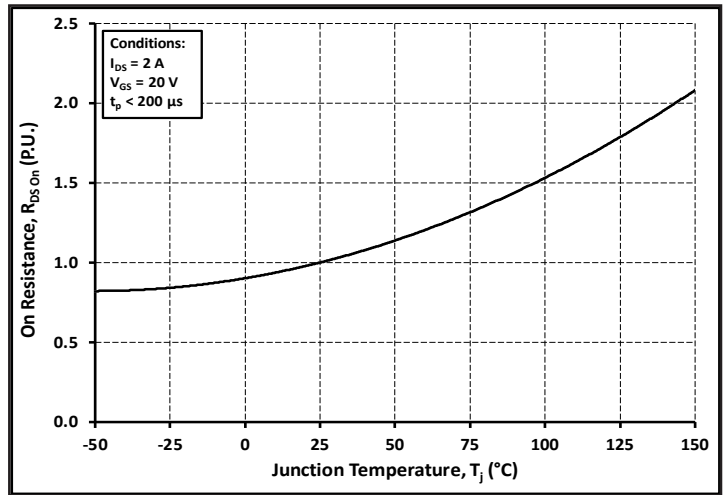

Figure 4. Normalized On-Resistance vs. Temperature

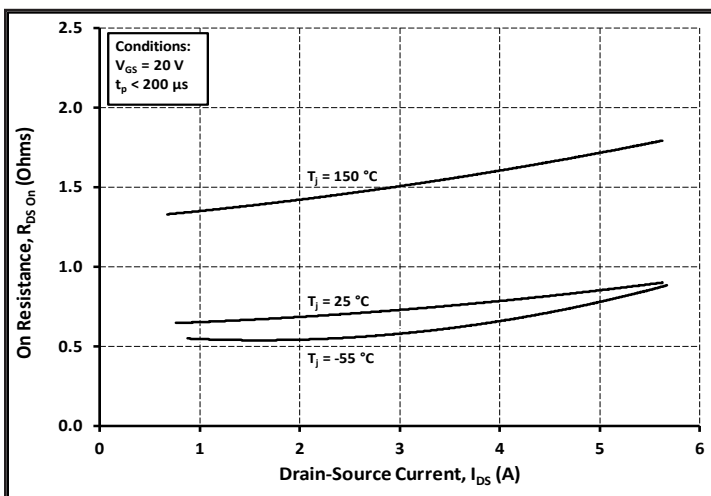

Figure 5. On-Resistance vs. Drain Current For Various Temperatures

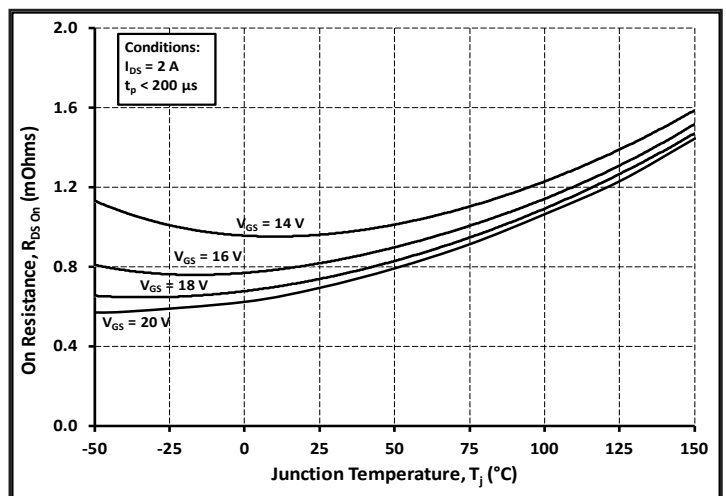

Figure 6. On-Resistance vs. Temperature For Various Gate Voltage

Typical Performance

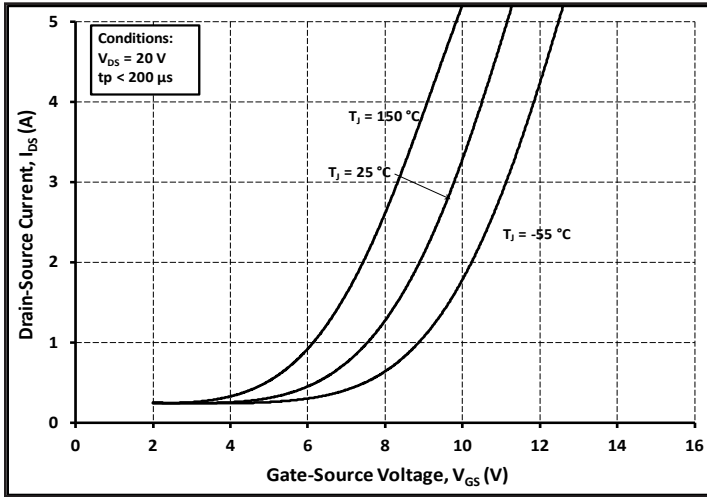

Figure 7. Transfer Characteristic for Various Junction Temperatures

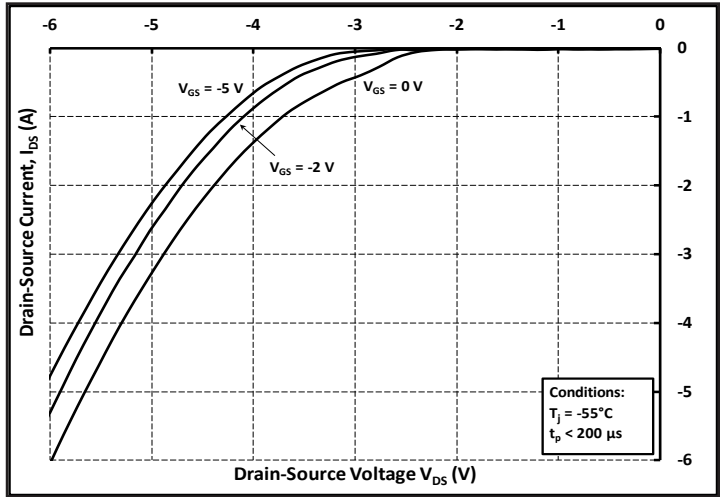

Figure 8. Body Diode Characteristic at -55 °C

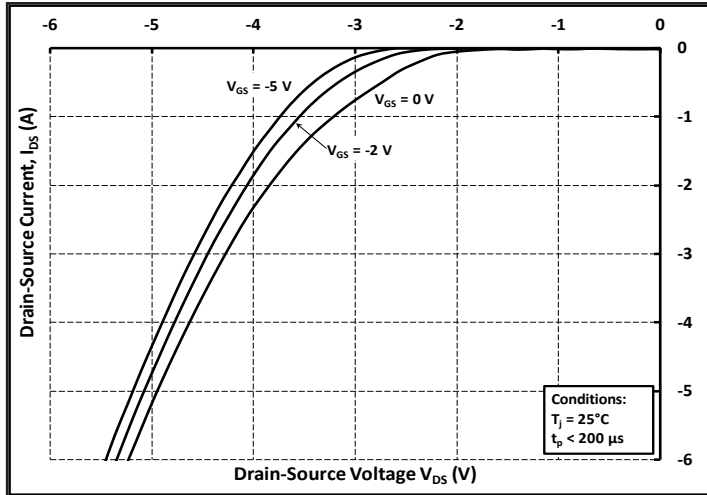

Figure 9. Body Diode Characteristic at 25 °C

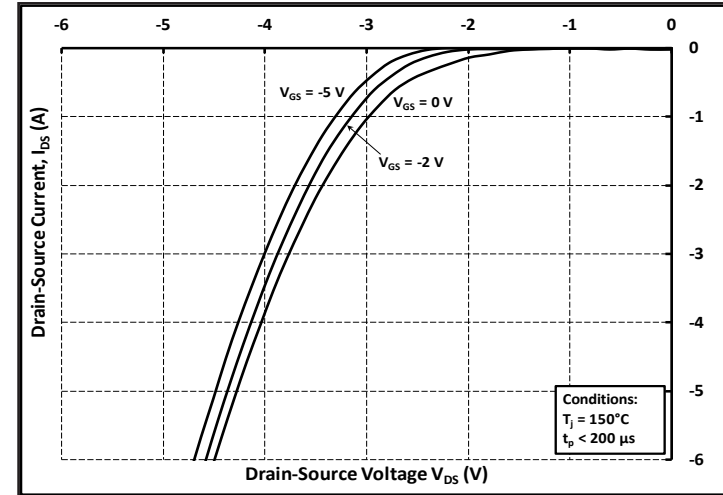

Figure 10. Body Diode Characteristic at 150 °C

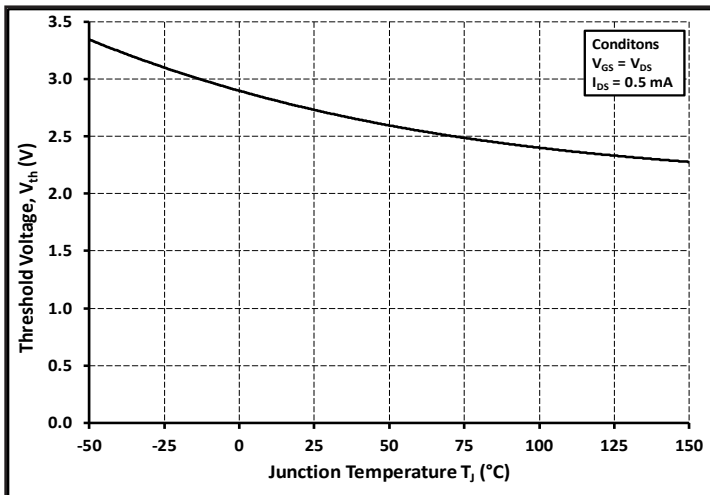

Figure 11. Threshold Voltage vs. Temperature

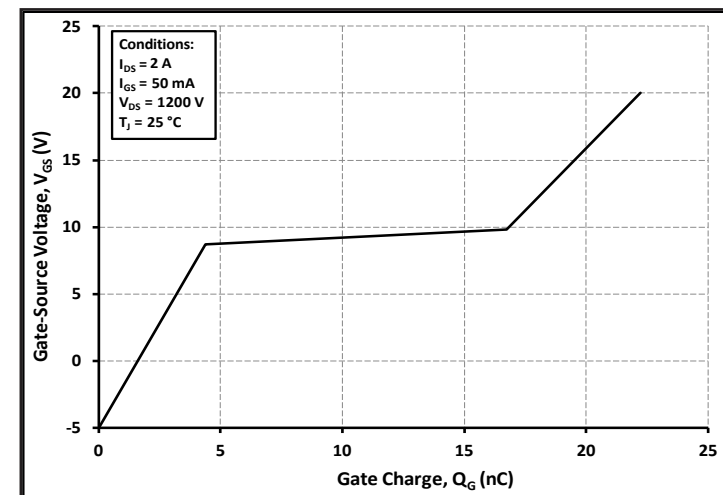

Figure 12. Gate Charge Characteristics

Typical Performance

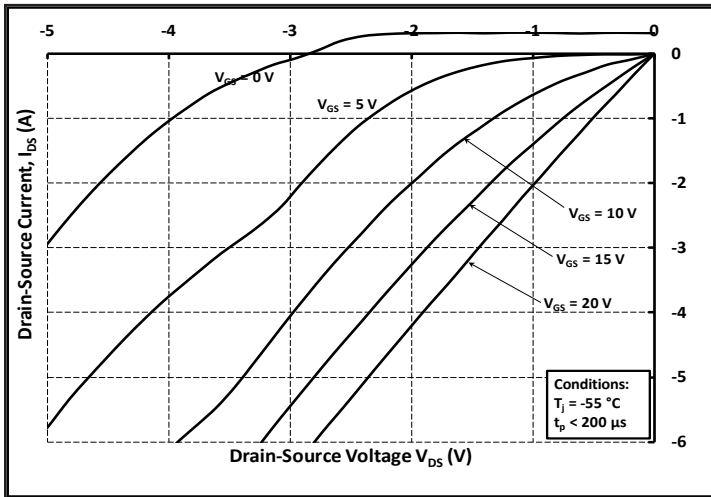

Figure 13. 3rd Quadrant Characteristic at -55 °C

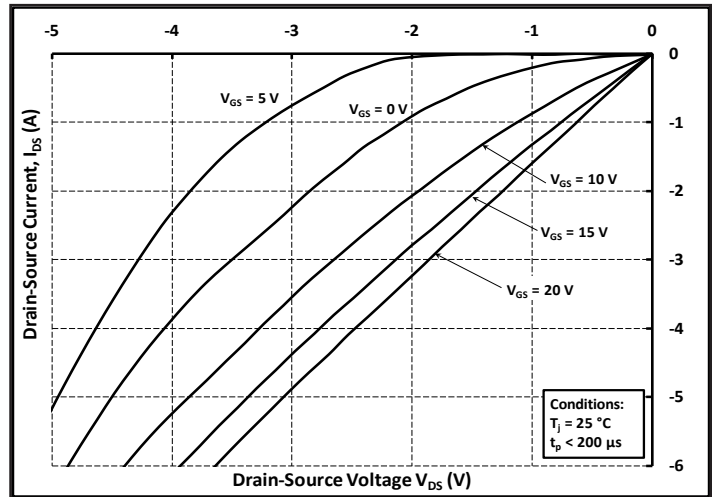

Figure 14. 3rd Quadrant Characteristic at 25 °C

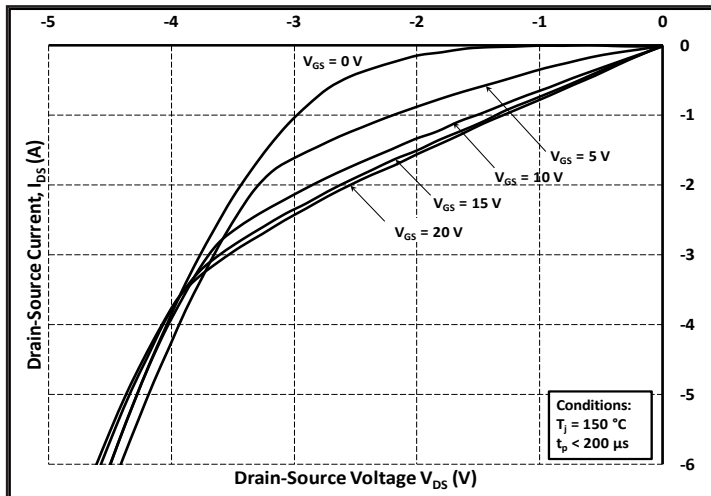

Figure 15. 3rd Quadrant Characteristic at 150 °C

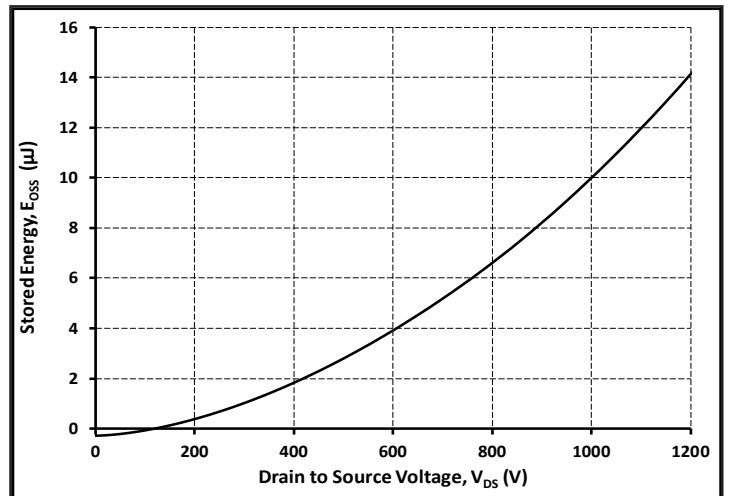

Figure 16. Output Capacitor Stored Energy

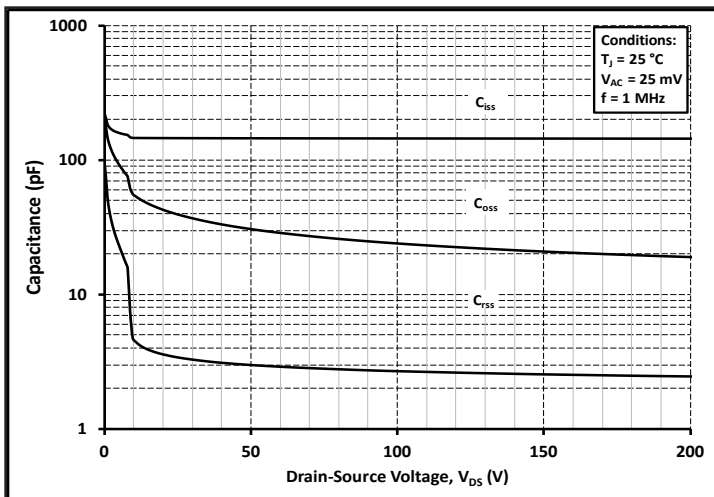

Figure 17. Capacitances vs. Drain-Source Voltage (0-200 V)

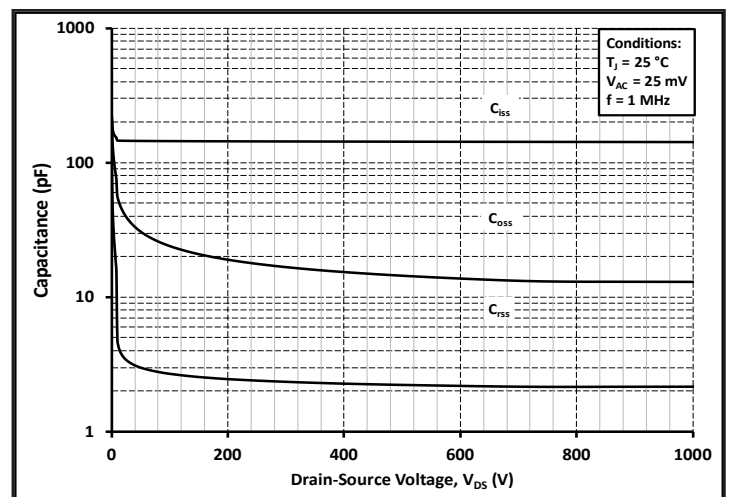

Figure 18. Capacitances vs. Drain-Source Voltage (0-1000 V)

Typical Performance

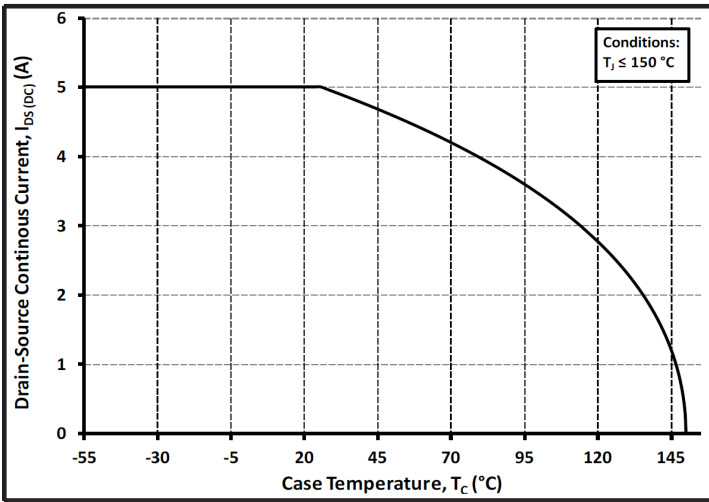

Figure 19. Continuous Drain Current Derating vs. Case Temperature

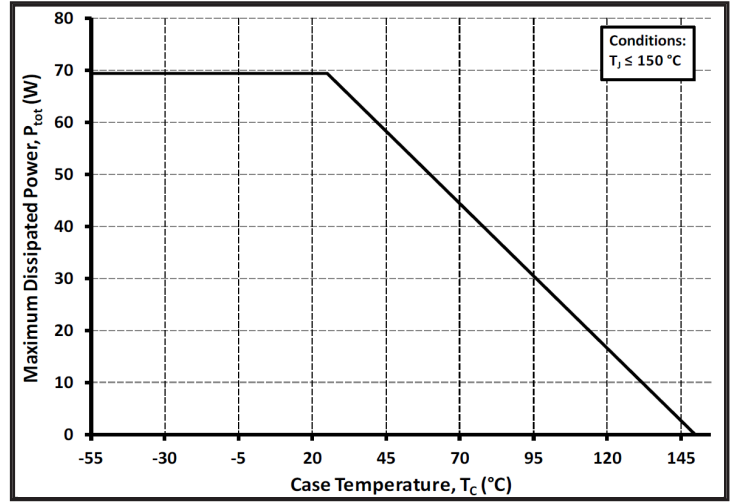

Figure 20. Maximum Power Dissipation Derating Vs Case Temperature

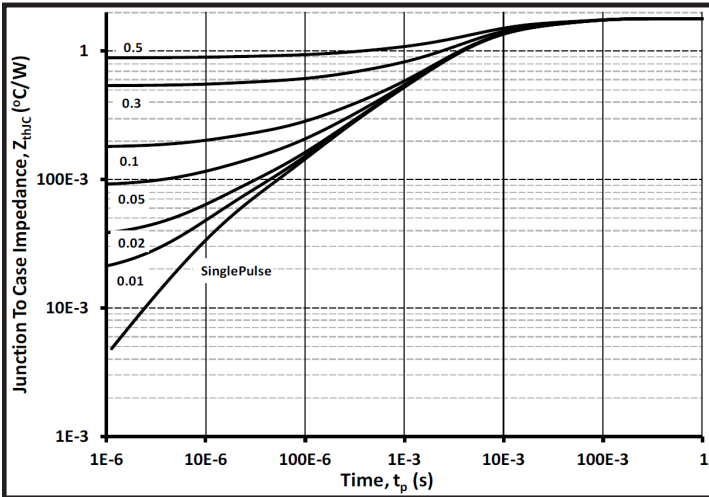

Figure 21. Transient Thermal Impedance (Junction - Case)

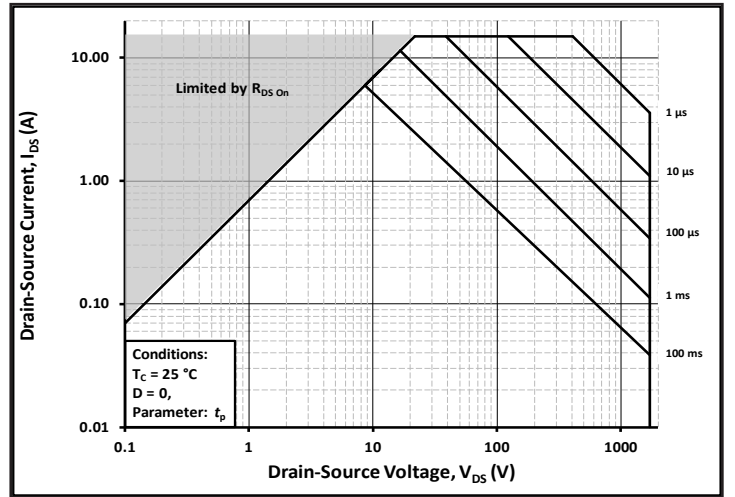

Figure 22. Safe Operating Area

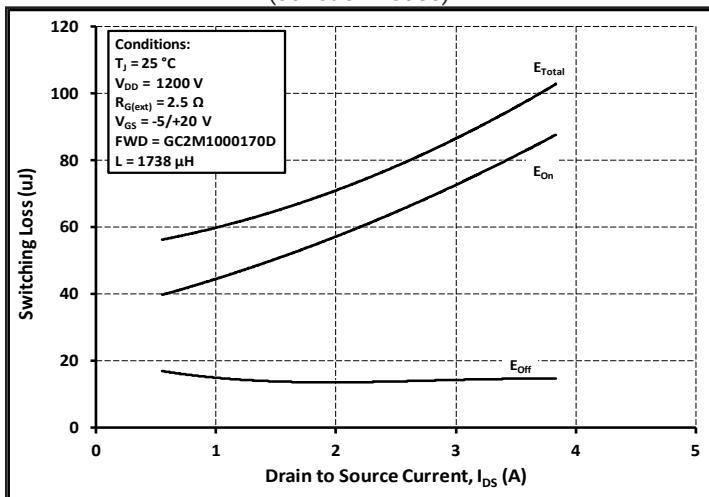

Figure 23. Clamped Inductive Switching Energy vs. Drain Current ($V_{DD} = 1200V$)

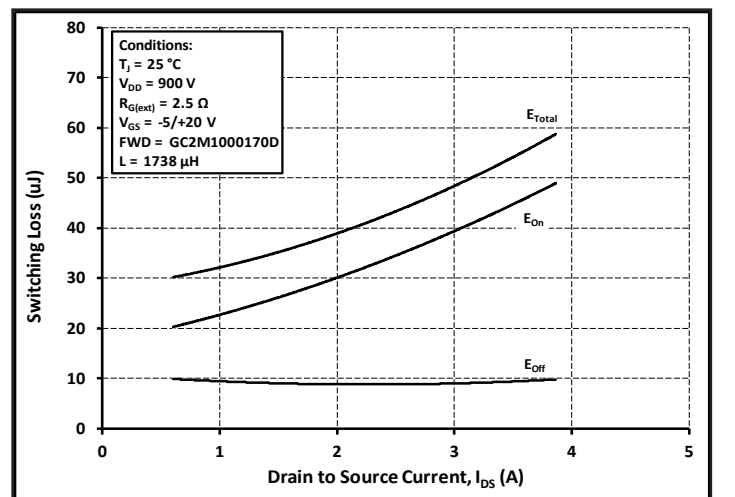

Figure 24. Clamped Inductive Switching Energy vs. Drain Current ($V_{DD} = 900V$)

Typical Performance

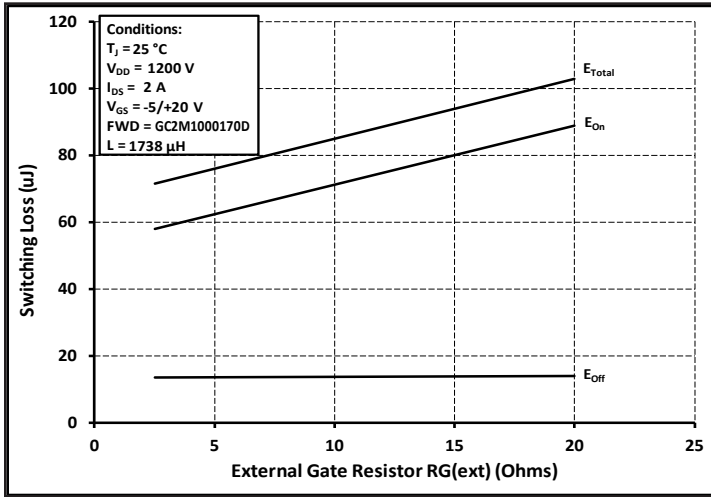

Figure 25. Clamped Inductive Switching Energy vs. $R_{G(ext)}$

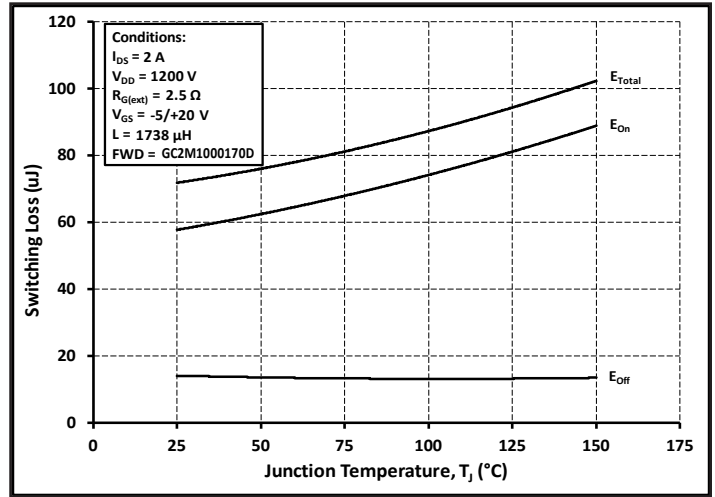

Figure 26. Clamped Inductive Switching Energy vs. Temperature

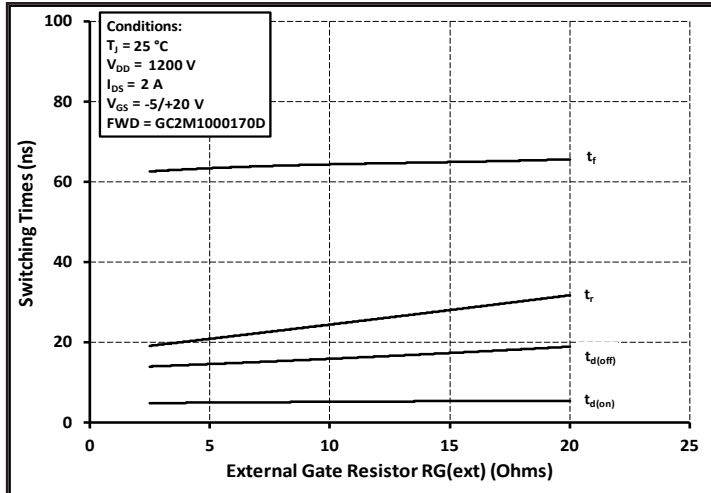

Figure 27. Switching Times vs. $R_{G(ext)}$

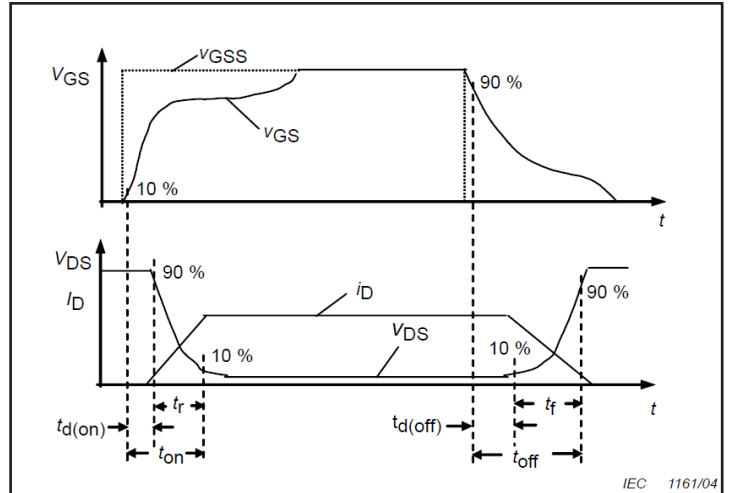

Figure 28. Switching Times Definition

Test Circuit Schematic

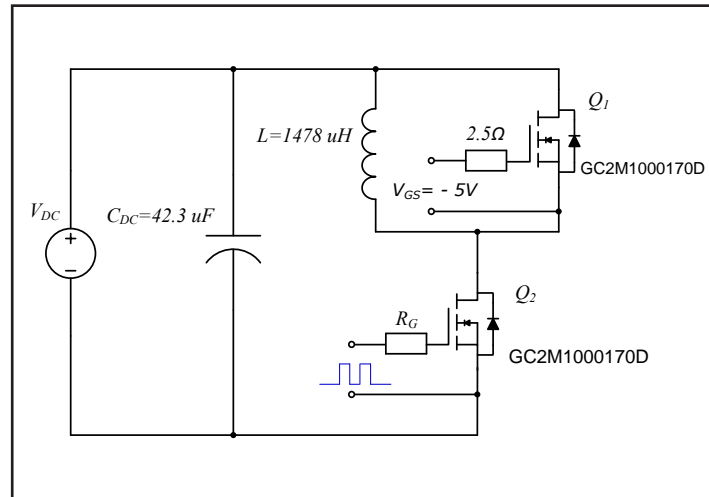

Figure 29. Clamped Inductive Switching
Waveform Test Circuit

ESD Ratings

ESD Test	Total Devices Sampled	Resulting Classification
ESD-HBM	All Devices Passed 4000V	3A (>4000V)
ESD-CDM	All Devices Passed 1000V	IV (>1000V)

Package Dimensions

Package TO-247-3

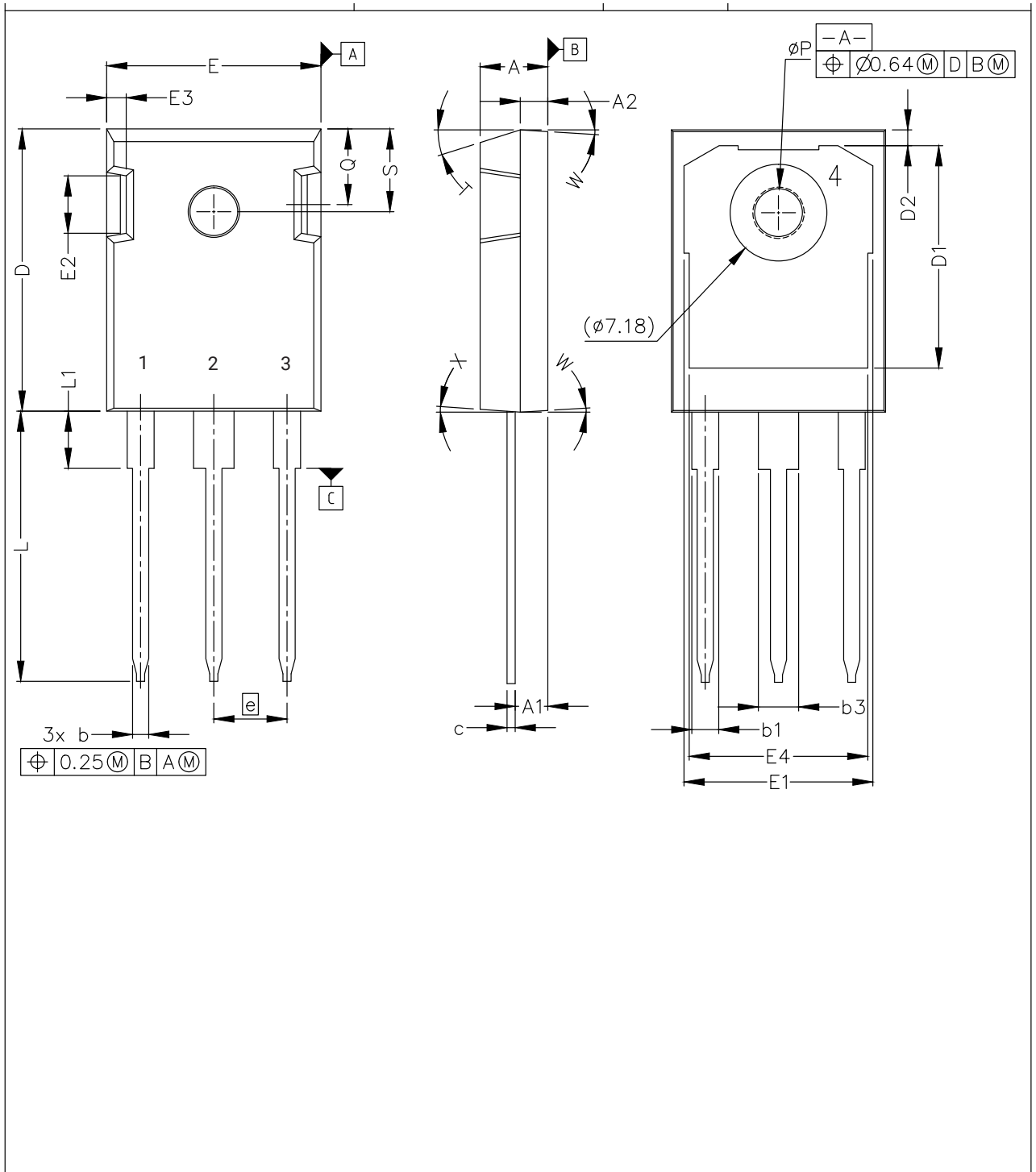

Package Dimensions

Package TO-247-3

SYM	MILLIMETERS		INCHES	
	MIN	MAX	MIN	MAX
A	4.83	5.21	.190	.205
A1	2.29	2.54	.090	.100
A2	1.91	2.16	.075	.085
b	1.07	1.33	.042	.052
b1	1.91	2.41	.075	.095
b3	2.87	3.38	.113	.133
c	0.55	0.68	.022	.027
D	20.80	21.10	.819	.831
D1	16.25	17.65	.640	.695
D2	0.95	1.25	.037	.049
E	15.75	16.13	.620	.635
E1	13.10	14.15	.516	.557
E2	3.68	5.10	.145	.201
E3	1.00	1.90	.039	.075
E4	12.38	13.43	.487	.529
e	5.44 BSC		.214 BSC	
N	3		3	
L	19.81	20.32	.780	.800
L1	4.10	4.40	.161	.173
ΦP	3.51	3.65	.138	.144
Q	5.49	6.00	.216	.236
S	6.04	6.30	.238	.248
T	17.5° REF.			
W	3.5° REF.			
X	4° REF.			

Recommended Solder Pad Layout

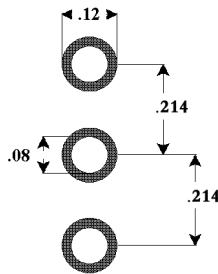

TO-247-3