



ORIENT

Photo coupler

Product Data Sheet

Part Number: OR-MOC302X(L)/305X(L)/307X(L)

Customer: _____

Date: _____

SHENZHEN ORIENT COMPONENTS CO., LTD

Block A 3rd Floor No.4 Building, Tian'an Cyber Park, Huangge Rd, LongGang Dist, Shenzhen, GD

TEL: 0755-29681816

FAX: 0755-29681200

www.orient-opto.com

1. Features

- (1) High isolation voltage between input and output (Viso:5000 V rms)
- (2) 6pin non-zero-cross optoisolators triac driver output
- (3) High repetitive peak off-state voltage VDRM :
- (4) OR-MOC302X: Min. 400V;OR-MOC305X: Min. 600V;OR-MOC307X: Min. 800V
- (5) High critical rate of rise of off-state voltage(dV/dt : MIN. 1000V / μ s)
- (6) Have Dual-in-line package;Wide lead spacing package and Surface mounting package .
- (7) Operating temperature -40 °C to +110 °C
- (8) Safety approval
 UL approved(No.E323844)
 VDE approved(No.40029733)
 CQC approved (No.CQC19001231480)
- (9) In compliance with RoHS, REACH standards
- (10) MSL Level 1

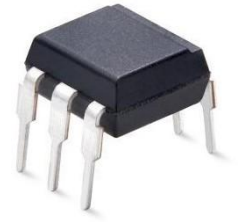

2. Description

The OR-MOC302X(L)/305X(L)/307X(L) series of devices each consist of a GaAs infrared emitting diode optically coupled to a monolithic silicon non zero voltage crossing photo triac.They are designed for use with a discrete power triac in the interface of logic systems , such as solid-state relays, industrial controls, motors, solenoids and consumer appliances.

3. Application Range

- AC Motor Drives
- AC Motor Starters
- Static power switch
- Lighting Controls
- Solenoid/Valve Controls
- Solid State Relays
- Temperature Controls

4. Absolute Maximum Ratings (Ta=25°C)

Parameter		Symbol	Rateing	Unit
Input	Forward Current	I _F	50	mA
	Junction Temperature	T _J	125	°C
	Reverse Voltage	V _R	6	V
	Power Dissipation	P	120	mW
Output	Off-State Output Terminal Voltage	OR-MOC302X	400	V
		OR-MOC305X	600	
		OR-MOC307X	800	
	On-State RMS Current	I _{T(RMS)}	100	mA
	Peak Repetitive Surge Current (PW=1ms, 120 pps)	I _{TSM}	1	A
	Junction Temperature	T _J	125	°C
	Collector Power Dissipation	P _C	150	mW
Total Power Dissipation		P _{tot}	250	mW
*Insulation Voltage		V _{iso}	5000	V _{rms}
Working Temperature		T _{opr}	-40 ~ + 110	°C
Deposit Temperature		T _{stg}	-55 ~ + 125	
*2 Soldering Temperature		T _{sol}	260	

*1 AC for 1 minute, R.H.= 40 ~ 60% R.H. In this test, pins 1, 2&3 are shorted together, and pins 4, 6 are shorted together.

* 2 For 10 second

5. Electrical Optical Characteristics at Ta=25°C

Parameter		Symbol	Min	Typ.	Max	Unit	Condition			
Input	Forward Voltage	V_F	---	1.2	1.6	V	$I_F=20\text{mA}$			
	Reverse Current	I_R	---	---	5	μA	$V_R=6\text{V}$			
Output	1. Peak Blocking Current, Either Direction	OR-MOC302X OR-MOC305X	---	10	100	nA	$V_{\text{DRM}} = \text{Rated } V_{\text{DRM}}$			
		OR-MOC307X						---	---	500
	Peak On-State Voltage, Either Direction	V_{TM}	---	---	3.0	V	$I_{\text{TM}}=100\text{mA Peak}$			
	2. Critical rate of Rise of Off-State Voltage	dv/dt	1000	---	---	$\text{V}/\mu\text{s}$	$V_{\text{in}}=240\text{V}_{\text{rms}}$			
Couple	3. Led Trigger Current, Current Required to Latch Output, Either Direction	OR-MOC3020 OR-MOC3050 OR-MOC3070	I_{FT}	---	---	mA	Main Terminal Voltage = 3V			
		OR-MOC3021 OR-MOC3051 OR-MOC3071						---	---	15
		OR-MOC3022 OR-MOC3052 OR-MOC3072						---	---	10
		OR-MOC3023 OR-MOC3053 OR-MOC3073						---	---	5
		OR-MOC3024 OR-MOC3054 OR-MOC3074						---	---	3.5
	Holding Current, Either Direction	OR-MOC302X OR-MOC305X	I_{H}	---	200	---	μA			
OR-MOC307X		---							540	---

*1. Test voltage must be applied within dv/dt rating.

*2. This is static dv/dt . Commutating dv/dt is a function of the load-driving thyristor(s) only.

*3. All devices are guaranteed to trigger at an I_F value less than or equal to $\max I_{\text{FT}}$. Therefore, recommended operating I_F lies between $\max I_{\text{FT}}$, 30 mA for OR-MOC3020, OR-MOC3050 and OR-MOC3070, 15 mA for OR-MOC3021, OR-MOC3051 and OR-MOC3071, 10 mA for OR-MOC3022, OR-MOC3052 and OR-MOC3072, 5 mA for OR-MOC3023, OR-MOC3053 and OR-MOC3073, 3.5 mA for OR-MOC3024, OR-MOC3054 and OR-MOC3074, and absolute $\max I_F$ (50mA).



6. Order Information

Part Number

OR-MOC302X(L)V-W-Y
OR-MOC305X(L)V-W-Y
or OR-MOC307X(L)V-W-Y

Note

MOC302X(L)/305X(L)/307X(L)= Part number (X = 0,1, 2, 3,or 4).
 X = IFT Rank (0,1, 2, 3,or 4).
 V = Lead form option (S, M or None).
 W = Tape and reel option (TA,TA1 or none).
 Y = ‘V’ code for VDE safety (This options is not necessary).

* VDE Code can be selected.

Option	Description	Packing quantity
None	Standard DIP-6	66 units per tube
M	Wide lead bend (0.4 inch spacing)	66 units per tube
S(TA)	Surface mount lead form (low profile) + TA tape & reel option	1000 units per reel
S(TA1)	Surface mount lead form (low profile) + TA1 tape & reel option	1000 units per reel

7. Naming Rule

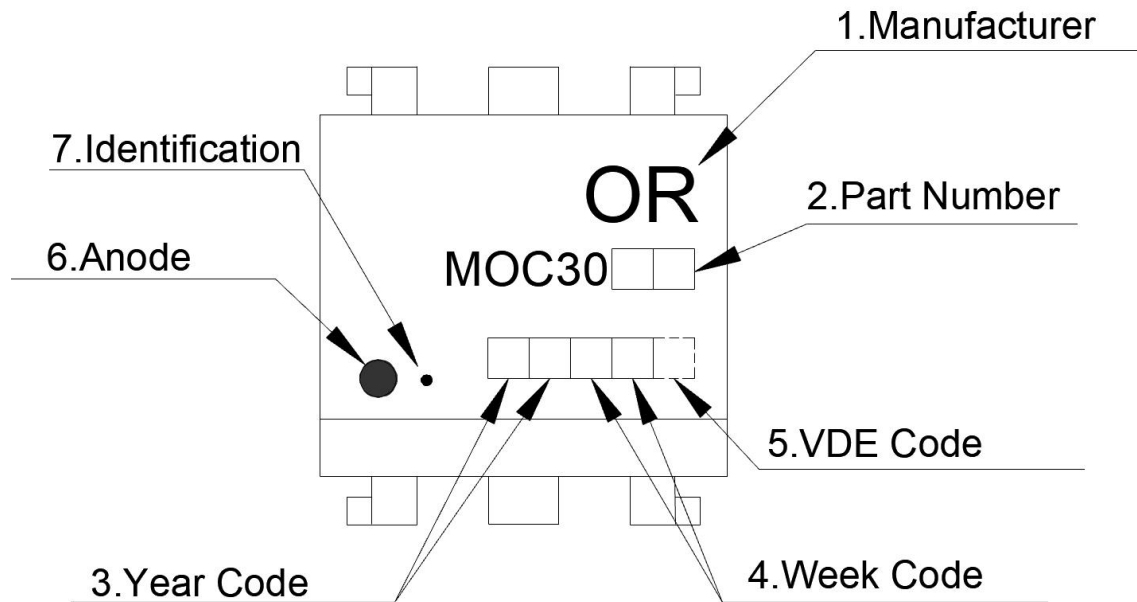

1. Manufacturer : ORIENT.
2. Part Number : MOC30□□.
3. Year Code □□ : '21' means '2021' and so on.
4. Week Code □□: 01 means the first week, 02 means the second week and so on.
5. VDE Code □□□. (Optional)
6. Anode.
7. Identification.

* VDE Code can be selected.

8. Package Dimension

(1).MOC30XX

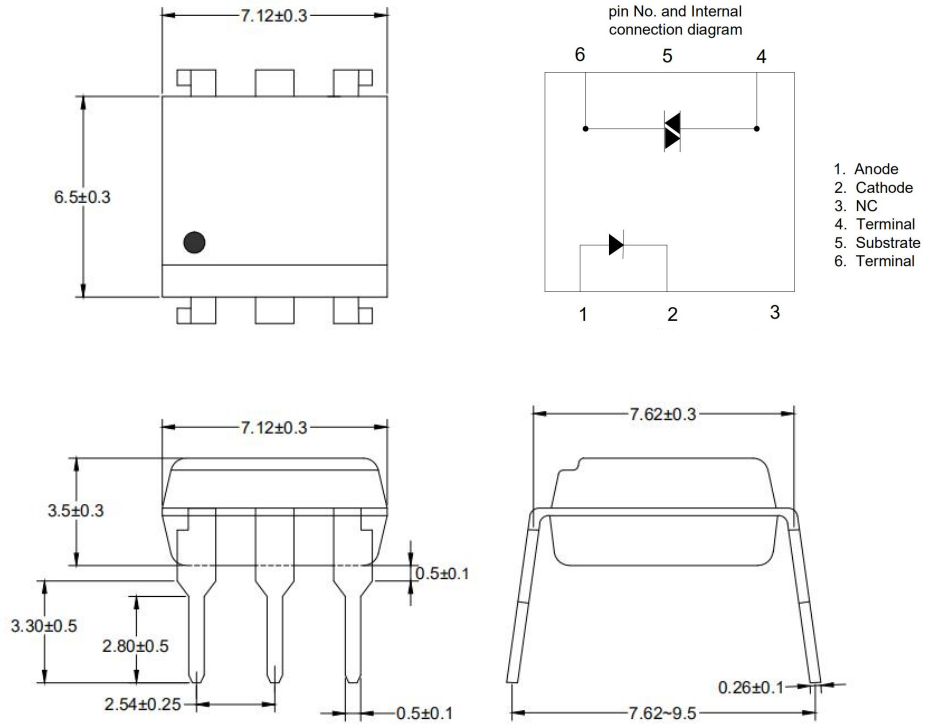

(2).MOC30XX M

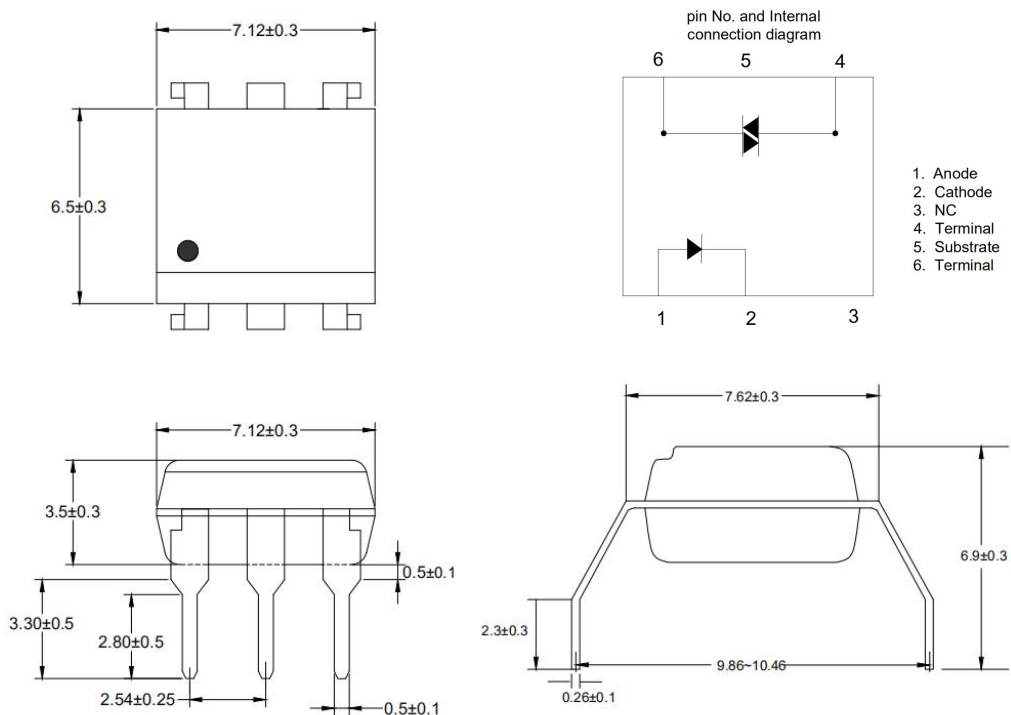

(3).MOC30XX S

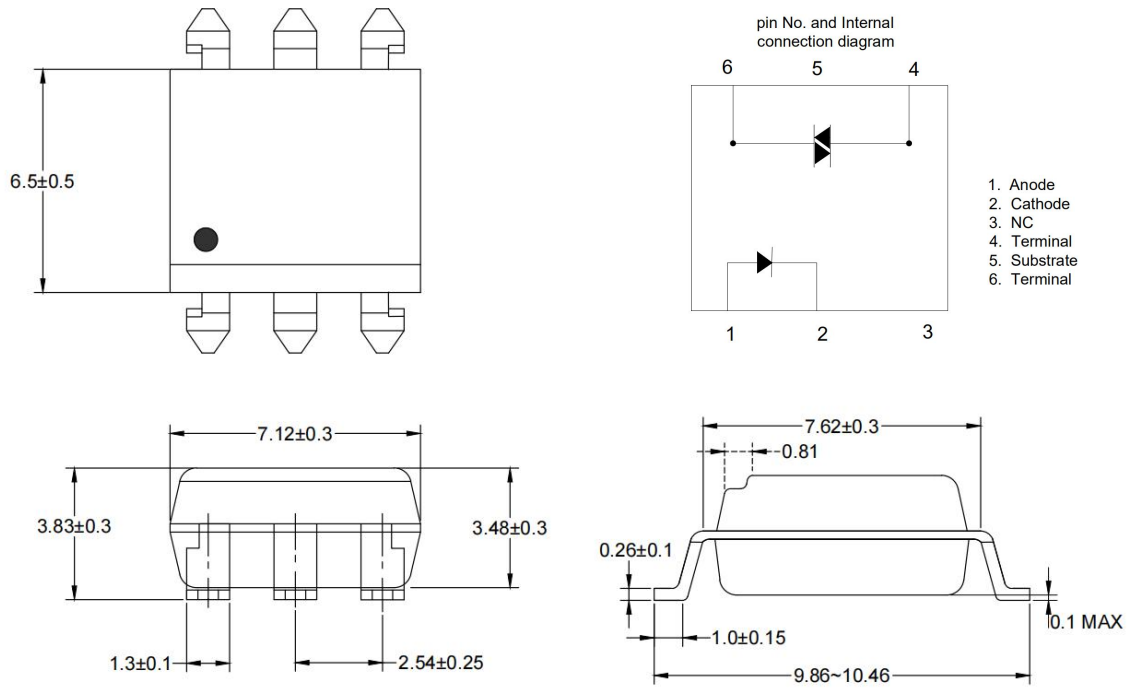

9. RRECOMMENDED FOOT PRINT PATTERNS (MOUNT PAD)

Unit: mm

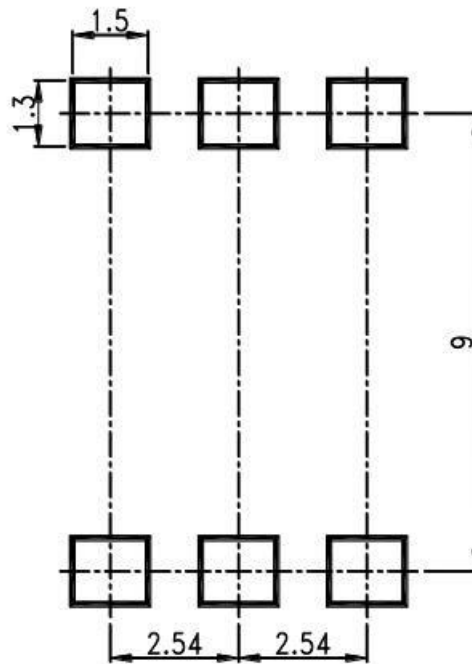

10. Taping Dimensions

(1)TA Type

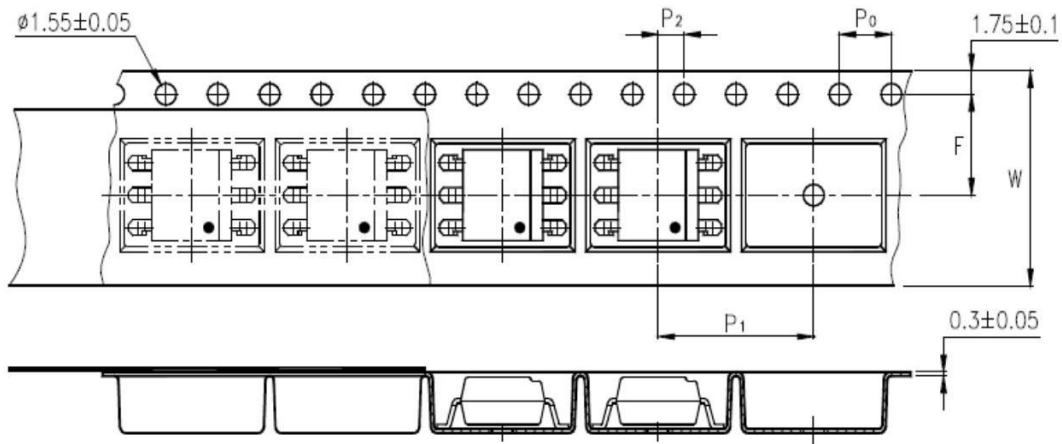

(2)TA1 Type

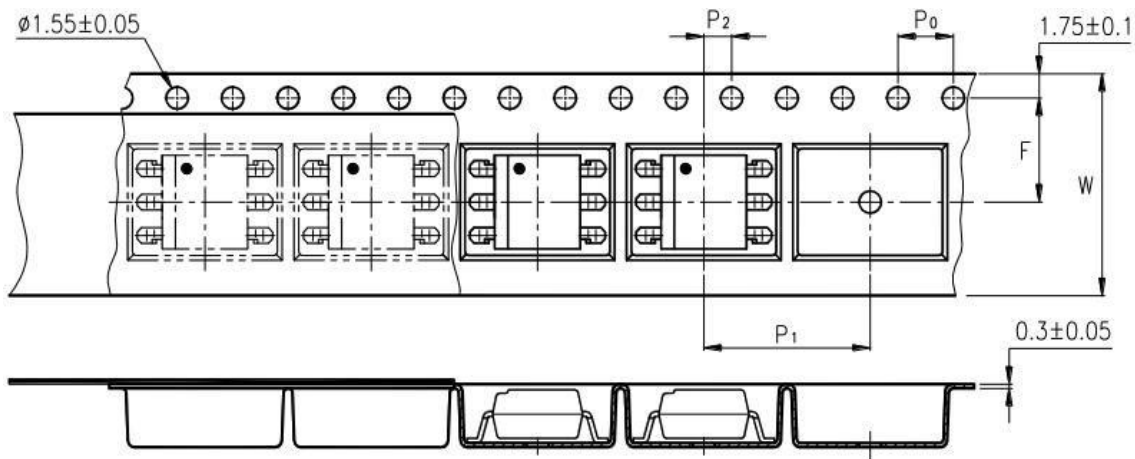

Description	Symbol	Dimension in mm (inch)
Tape wide	W	16±0.3 (0.63)
Pitch of sprocket holes	P ₀	4±0.1 (0.15)
Distance of compartment	F	7.5±0.1 (0.295)
	P ₂	2±0.1 (0.079)
Distance of compartment to compartment	P ₁	12±0.1 (0.472)

Package Type	TA/TA1
Quantities(pcs)	1000

11. Package Dimension

(1) package dimension





DIP Type

Packing Information	
Packing type	Tube
Qty per Tube	66pcs
Small box (Inner) Dimension	525*128*60mm
Large box (Outer) Dimension	545*290*335mm
The Amount per Inner Box	3,300pcs
The Amount per Outer Box	33,000pcs

SOP Type

Packing Information	
Packing type	Reel type
Tape Width	16mm
Qty per Reel	1,000pcs
Small box (inner) Dimension	345*345*58.5mm
Large box (Outer) Dimension	620x360x360mm
Max qty per small box	2,000pcs
Max qty per large box	20,000pcs

(2)Packing Label Sample

 <p>Material Code : 120PCXXXXXX P/N : OR-XXXXXX Lot No. : XXXXXX-XXXXX-TX-X D/C : XXXX Qty : XXXX PCS</p>	  
<div style="display: flex; justify-content: space-around;"> <div style="border: 1px solid black; padding: 5px; width: 40%;">内箱码</div> <div style="border: 1px solid black; padding: 5px; width: 40%;">外箱码</div> </div>	
<p>“XXXXXXXXXXXXXXXXXX” (一体机序列码) Made in China</p>	

Note:

1. Material Code :Product ID.
2. P/N :Contents with "Order Information" in the specification.
3. Lot No. :Product data.
4. D/C :Product weeks.
5. Quantity :Packaging quantity.

12. Temperature Profile Of Soldering

(1).IR Reflow soldering (JEDEC-STD-020C compliant)

One time soldering reflow is recommended within the condition of temperature and time profile shown below. Do not solder more than three times.

Profile item	Conditions
Preheat - Temperature Min (T Smin) - Temperature Max (T Smax) - Time (min to max) (ts)	150°C 200°C 90±30 sec
Soldering zone - Temperature (TL) - Time (t L)	217°C 60 sec
Peak Temperature	260°C
Peak Temperature time	20 sec
Ramp-up rate	3°C / sec max.
Ramp-down rate from peak temperature	3~6°C / sec
Reflow times	≤3

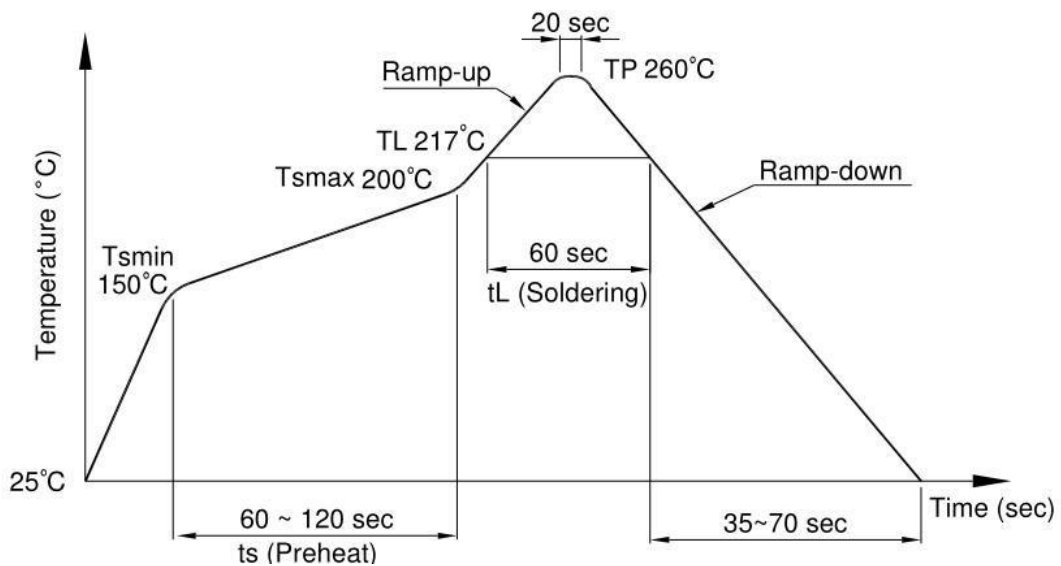

(3) .Wave soldering (JEDEC22A111 compliant)

One time soldering is recommended within the condition of temperature.

Temperature	260+0/-5°C
Time	10 sec
Preheat temperature	5 to 140°C
Preheat time	30 to 80 sec

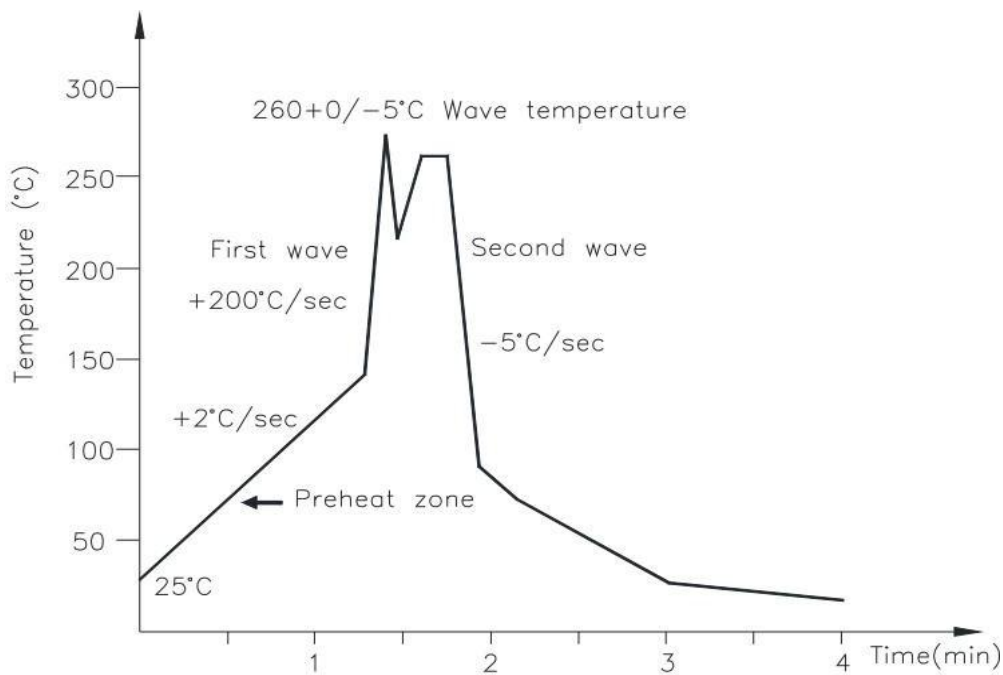

(3).Hand soldering by soldering iron

Allow single lead soldering in every single process. One time soldering is recommended.

Temperature	380+0/-5°C
Time	3 sec max

13. CHARACTERISTICS CURVES (TYPICAL PERFORMANCE)

Fig.1 Forward current vs Ambient temperature

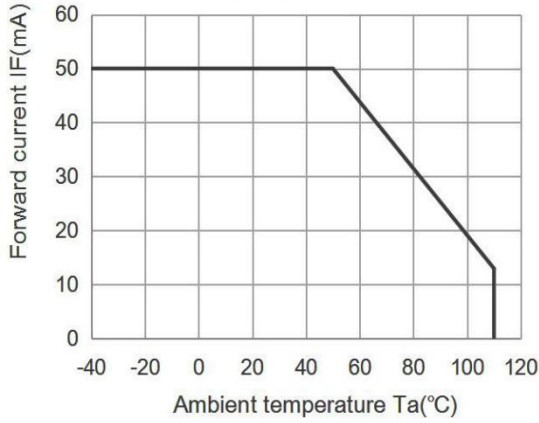

Fig.2 On-state current ITM (A) vs. Ambient temperature

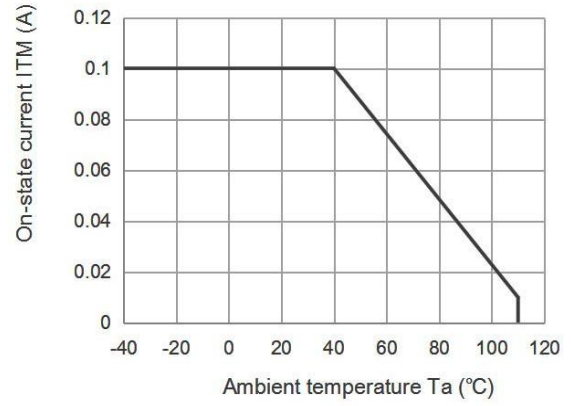

Fig.3 Minimum Trigger Current vs. Ambient temperature

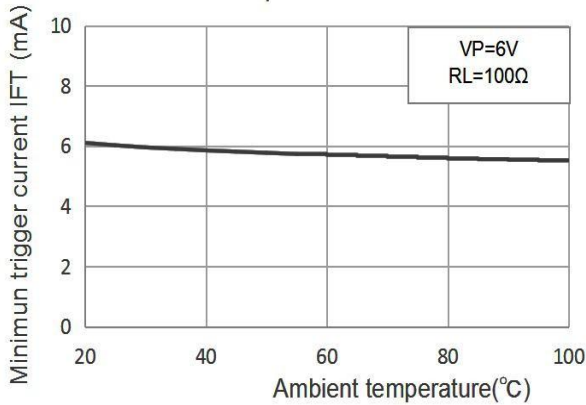

Fig.4 Forward current vs. Forward voltage

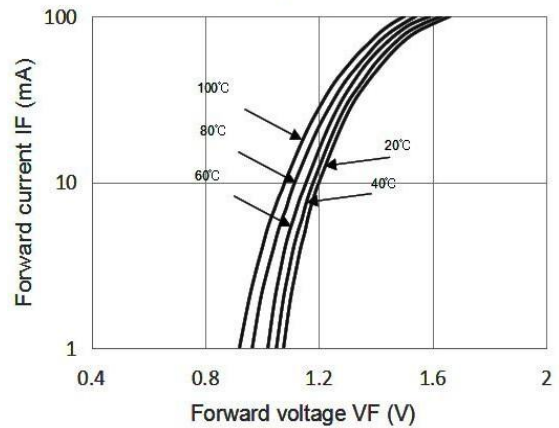

Fig.5 On-state voltage vs. Ambient temperature

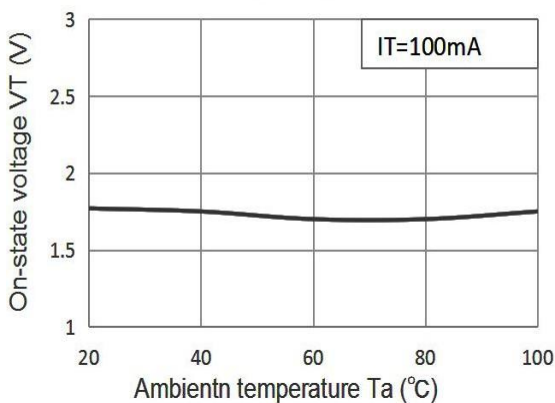

Fig.6 Holding current vs. Ambient temperature

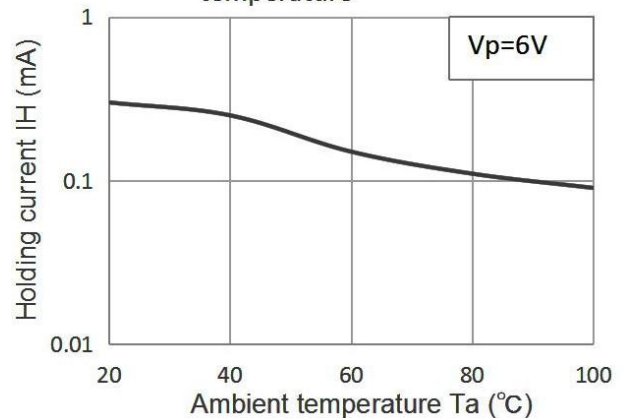

Fig.7 Repetitive peak off-state current vs. Temperature

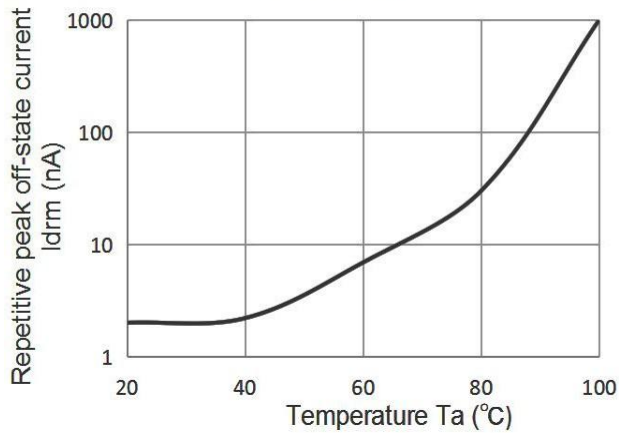
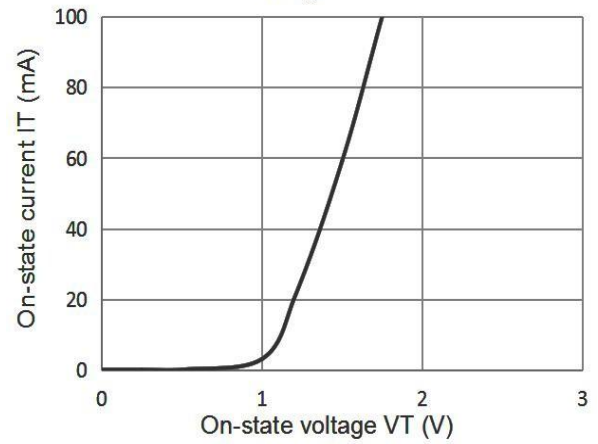

Fig.8 On-state current vs. On-state voltage



Basic Operation Circuit

Medium/High Power Triac Drive Circuit

