

### General Description

The SY6702 is an H-bridge motor driver solution for cameras, consumer products, toys, and other low-voltage or battery-powered motion-control applications. The device can drive one winding of a stepper motor or one brush DC motor. The highly integrated H-bridge driver block consists of two half-bridges with internal logic control, gate drive, over current protection and charge pump circuit.

The SY6702 operates with a power-supply voltage range from 2.5V to 16V, and 1.8A maximum output current.

To be compatible with industry-standard devices, the SY6702 use the PWM (IN/IN) input interface.

The SY6702 provides over current protection, short circuit protection, under voltage lockout and thermal shutdown.

### Features

- H-bridge motor driver
  - ♦ Drives a brush DC motor or one winding of a stepper motor or other loads
  - ♦ Low MOSFET on-resistance: HS + LS < 380mΩ
- 1.8A maximum drive current
- Power supply voltage range from 2.5V to 16V
- PWM (IN/IN) interface
- Low power sleep mode with 120nA maximum Combined supply current
- Low power with less than 120µA supply current
- Internal over current protection, short circuit protection, under voltage lockout and thermal shutdown
- Compact package: DFN2x2-8

### Applications

- Cameras
- DSLR Lenses
- Consumer Products
- Toys
- Robotics
- Medical Devices

### Ordering Information

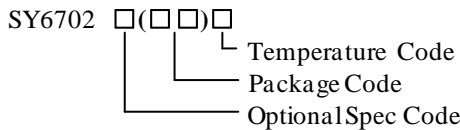

| Ordering Number | Package type | Note |
|-----------------|--------------|------|
| SY6702DFC       | DFN2x2-8     |      |

### Typical Applications

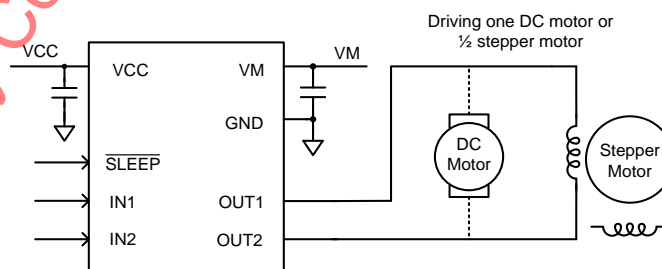
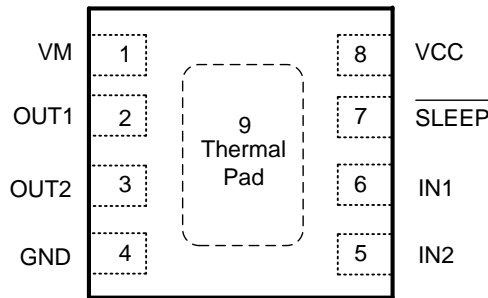

Figure 1. Schematic Diagram

## Pinout (top view)



|             |              |                       |
|-------------|--------------|-----------------------|
| Part Number | Package type | Top Mark <sup>①</sup> |
| SY6702DFC   | DFN2x2-8     | Eexyz                 |

Note ①: x=year code, y=week code, z=lot number code.

| Name        | DFN2x2-8 | Description   |
|-------------|----------|---|
| VM          | 1        | Motor power supply pin. Decouple this pin to GND pin with 10uF ceramic cap.                                 |
| OUT1        | 2        | Output 1 pin. Connect this pin to motor winding.  |
| OUT2        | 3        | Output 2 pin. Connect this pin to motor winding.  |
| GND         | 4        | Ground pin.   |
| IN2         | 5        | Input 2 pin. Logic high set OUT2 high; this pin has a internal pull-down resistor.                          |
| IN1         | 6        | Input 1 pin. Logic high set OUT1 high; this pin has a internal pull-down resistor.                          |
| SLEEP       | 7        | Sleep mode pin. Logic low puts device in low-power sleep mode, this pin has an internal pull-down resistor. |
| VCC         | 8        | Device power supply pin. Decouple this pin to GND pin with 0.1uF ceramic cap.                               |
| Thermal Pad | 9        | Thermal Pad.  |

## Absolute Maximum Ratings (Note 1)

|  |       |                   |
|--|-------|-------------------|
| VCC, OUT1, OUT2  | ----- | 16V               |
| VM   | ----- | 16V               |
| SLEEP  | ----- | 6V                |
| IN1, IN2   | ----- | 6V                |
| Junction Temperature (T <sub>J</sub> )                     | ----- | -40 °C to +150 °C |
| Storage Temperature  | ----- | -65 °C to +150 °C |
| Power Dissipation, P <sub>D</sub> @ T <sub>A</sub> = 25 °C | ----- | 2.5W              |
| Package Thermal Resistance (Note2)                         |       |                   |
| θ <sub>JA</sub> ,  | ----- | 50 °C/W           |
| θ <sub>JC</sub> ,  | ----- | 62 °C/W           |

## Recommended Operating Conditions

|                                 |       |                  |
|---------------------------------|-------|------------------|
| VCC                             | ----- | 2.5V to 16V      |
| VM                              | ----- | 2.5V to 16V      |
| SLEEP                           | ----- | 0V to 5.5V       |
| IN1, IN2                        | ----- | 0V to 5.5V       |
| Logic Input PWM Frequency       | ----- | 0Hz to 250kHz    |
| H-Bridge Output Current (Note3) | ----- | 0A to 1.8A       |
| Junction Temperature Range      | ----- | -40 °C to 125 °C |
| Ambient Temperature Range       | ----- | -40 °C to 85 °C  |

Block Diagram

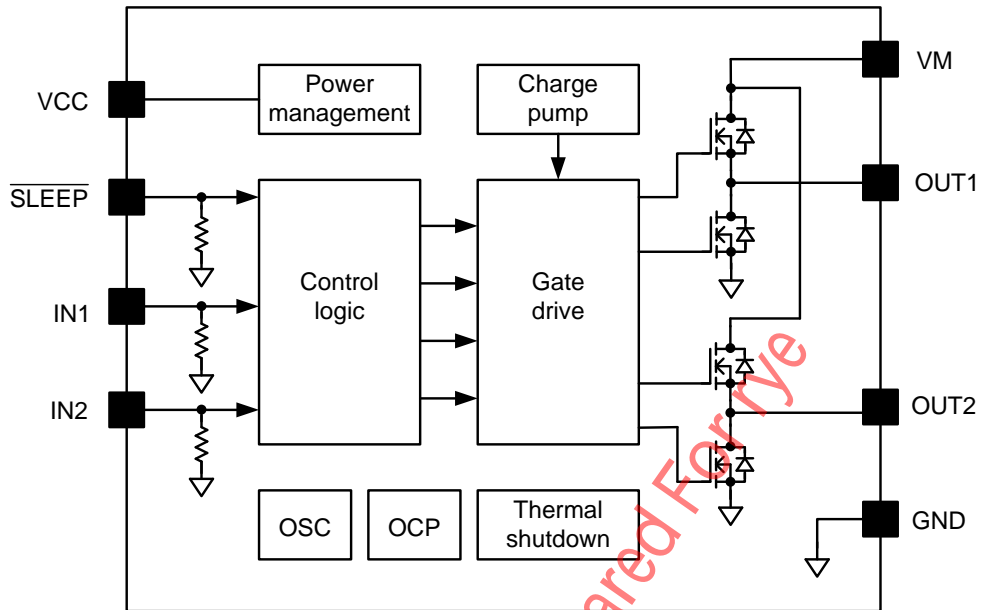

Silergy Corp. Confidential Prepared For Eye



**Electrical Characteristics**

(T<sub>A</sub> = 25 °C, V<sub>M</sub>=V<sub>CC</sub>=5V, unless otherwise specified)

| Parameter                         | Symbol                 | Test Conditions                             | Min | Typ | Max  | Unit |
|-----------------------------------|------------------------|---|-----|-----|------|------|
| <b>Power Supplies</b>             |                        |   |     |     |      |      |
| VM Operating Supply Current       | I <sub>VM</sub>        | No PWM                                      |     | 40  |      | μA   |
|                                   |                        | 50KHz PWM, OUTx Float                       |     | 0.8 |      | mA   |
| VM Sleep Mode Current             | I <sub>VMS</sub>       | SLEEP=0V                                    |     | 30  |      | nA   |
| VCC Sleep Mode Current            | I <sub>CCS</sub>       | SLEEP=0V                                    |     | 5   |      | nA   |
| VCC Operating Supply Current      | I <sub>CC</sub>        | No PWM                                      |     | 120 |      | μA   |
|                                   |                        | 50KHz PWM, OUTx Float                       |     | 0.7 |      | mA   |
| VCC Under voltage Lockout Voltage | V <sub>UVLO_RISE</sub> | VCC Rising                                  |     |     | 2.2  | V    |
|                                   | V <sub>UVLO_FALL</sub> | VCC Falling                                 |     |     | 2.1  | V    |
| <b>Logic Level Input</b>          |                        |   |     |     |      |      |
| Input Low Voltage                 | V <sub>IL</sub>        |   |     |     | 0.8  | V    |
| Input High Voltage                | V <sub>IH</sub>        |   | 2   |     |      | V    |
| Input Hysteresis                  | V <sub>IHYS</sub>      |   |     | 0.2 |      | V    |
| Input Low Current                 | I <sub>IL</sub>        | V <sub>IN</sub> =0V                         | -5  |     | 5    | μA   |
| Input High Current                | I <sub>IH</sub>        | V <sub>IN</sub> =3.3V                       |     |     | 50   | μA   |
| Pulldown Resistance               | R <sub>PD</sub>        |   |     | 100 |      | kΩ   |
| <b>H-Bridge MOSFETs</b>           |                        |   |     |     |      |      |
| HS + LS MOSFETs On Resistance     | R <sub>dson</sub>      | I <sub>O</sub> =800mA, T <sub>J</sub> =25°C |     | 380 | 430  | mΩ   |
| Off-State Leakage Current         | I <sub>OFF</sub>       | V <sub>OUT</sub> =0V                        |     |     | ±200 | nA   |
| <b>Protection</b>                 |                        |   |     |     |      |      |
| Output Over Current Limit         | I <sub>OCP</sub>       |   | 1.9 |     | 3.5  | A    |
| Over Current Retry Time           | t <sub>OCPR</sub>      |   |     | 1   |      | ms   |
| Thermal Shutdown Temperature      | T <sub>SD</sub>        |   | 140 | 150 |      | °C   |
| Thermal Shutdown hysteresis       | T <sub>HYS</sub>       |   |     | 20  |      | °C   |

**Note 1:** Stresses beyond the “Absolute Maximum Ratings” may cause permanent damage to the device. These are stress ratings only. Functional operation of the device at these or any other conditions beyond those indicated in the operational sections of the specification is not implied. Exposure to absolute maximum rating conditions for extended periods may affect device reliability.

**Note 2:** θ<sub>JA</sub> and θ<sub>JC</sub> are measured in the natural convection at T<sub>A</sub> = 25 °C on a high effective four-layer thermal conductivity test board of JEDEC 51-5 and 51-7 thermal measurement standard.

**Note 3:** Power dissipation and thermal limits must be observed.

## Typical performance characteristics

Operation Waveform  
(VCC=VM=5V, I<sub>o</sub>=0.5A, IN1=High)

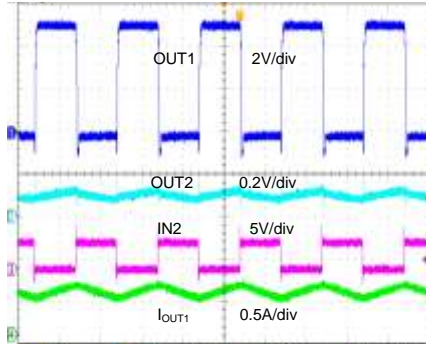

Time (2µs/div)

Operation Waveform  
(VCC=VM=5V, I<sub>o</sub>=1.8A, IN1=High)

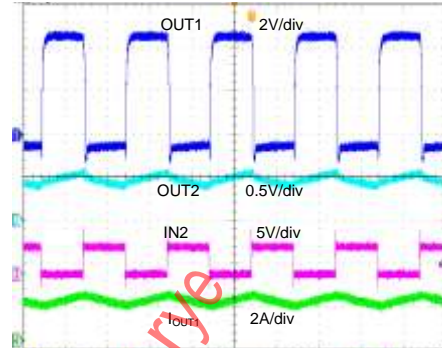

Time (2µs/div)

Operation Waveform  
(VCC=VM=16V, I<sub>o</sub>=0.5A, IN1=High)

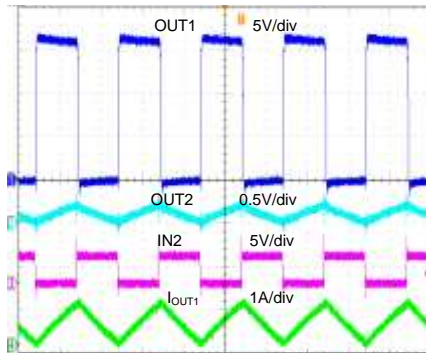

Time (2µs/div)

Operation Waveform  
(VCC=VM=16V, I<sub>o</sub>=1.8A, IN1=High)

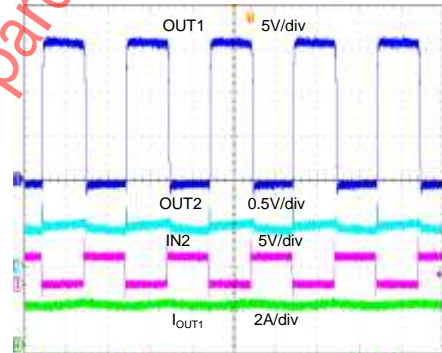

Time (2µs/div)

Operation Waveform  
(VCC=VM=5V, I<sub>o</sub>=0.5A, IN2=IN1)

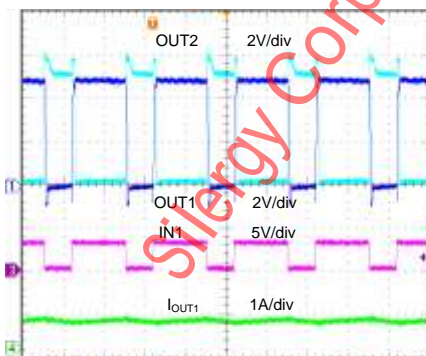

Time (2µs/div)

Operation Waveform  
(VCC=VM=16V, I<sub>o</sub>=0.5A, IN2=IN1)

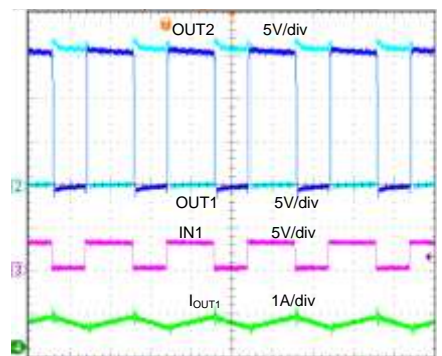

Time (2µs/div)

## Operation

### Timing Requirements

( $T_A = 25\text{ }^\circ\text{C}$ ,  $V_{CC}=3\text{V}$ ,  $V_M=5\text{V}$ ,  $R_L=20\Omega$ , unless otherwise specified)

|   |       |                                  | Min | Max | Unit |
|---|-------|----------------------------------|-----|-----|------|
| 1 | $t_1$ | Output Enable Time               |     | 120 | ns   |
| 2 | $t_2$ | Output Disable Time              |     | 120 | ns   |
| 3 | $t_3$ | Delay Time, INx High to OUTy Low |     | 120 | ns   |
| 4 | $t_4$ | Delay Time, INy Low to OUTx High |     | 120 | ns   |
| 5 | $t_5$ | Output Rise Time                 | 50  | 150 | ns   |
| 6 | $t_6$ | Output Fall Time                 | 50  | 150 | ns   |

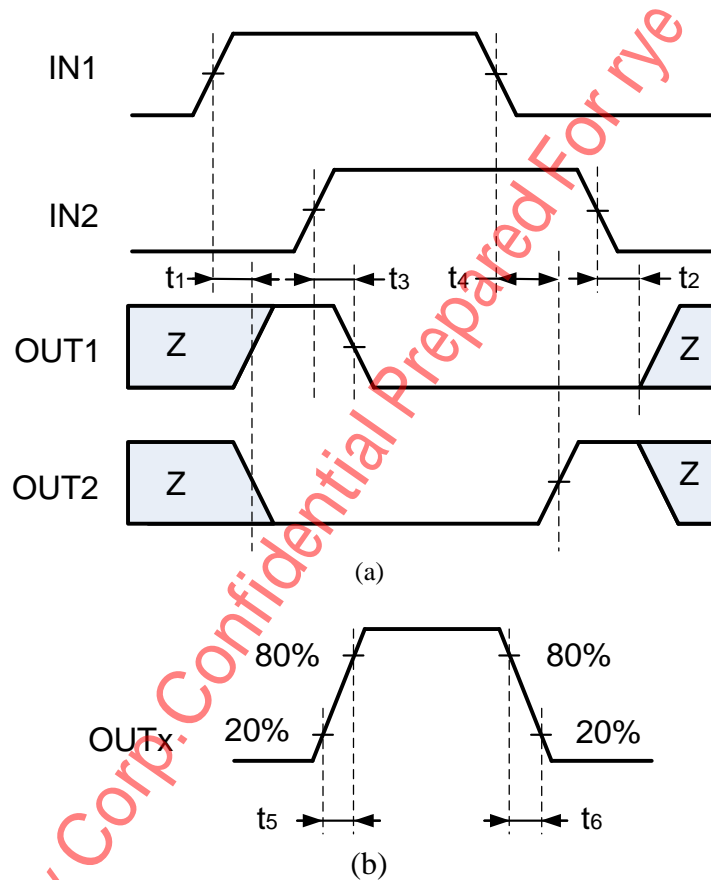

Figure 3. Input/Output Timing

### H-Bridge Driving Control

The Bridge is controlled by a PWM input interface, also called IN/IN interface. The following table shows the control logic of the device:

| IN1 | IN2 | OUT1 | OUT2 | Function (DC Motor) |
|-----|-----|------|------|---------------------|
| 0   | 0   | Z    | Z    | Coast               |
| 0   | 1   | L    | H    | Reverse             |
| 1   | 0   | H    | L    | Forward             |
| 1   | 1   | L    | L    | Brake               |



## **Sleep Mode**

If the SLEEP pin is brought to a logic-low state, the device enters a low-power sleep mode. In this state, all unnecessary internal circuitry is powered down.

## **Over Current Protection (OCP)**

A current limit circuit on each MOSFET limits the current through the MOSFET by removing the gate drive. If this current limit persists for longer than the OCP time, all MOSFETs in the H-bridge are disabled. After approximately 1 ms, the bridge is re-enabled automatically.

Over current conditions on both high and low side devices, that is, a short to ground, supply, or across the motor winding all result in an over current shutdown.

## **Thermal Shutdown (TSD)**

If the die temperature exceeds safe limits, all MOSFETs in the H-bridge are disabled. Once the die temperature has fallen to a safe level, operation automatically resumes.

## **Under Voltage Lockout (UVLO)**

If at any time the voltage on the VCC pin falls below the undervoltage lockout threshold voltage, all circuitry in the device is disabled and internal logic is reset. Operation resumes when VCC rises above the UVLO threshold.

Silergy Corp. Confidential Prepared For Eye

## DFN2x2-8 Package Outline (Type C)

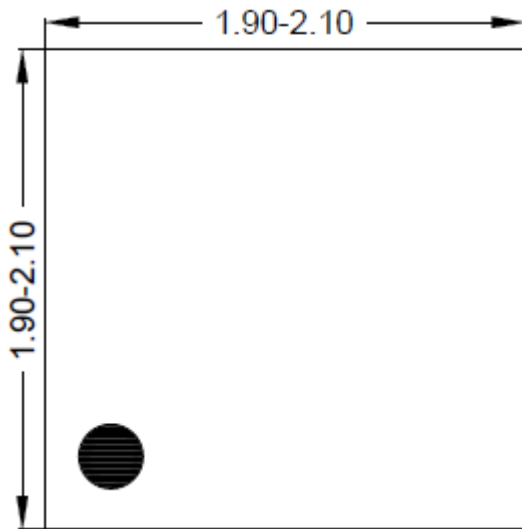

Top View

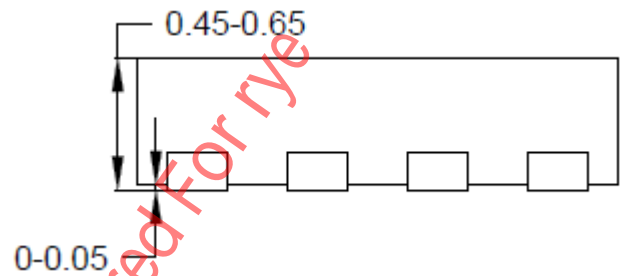

Side View

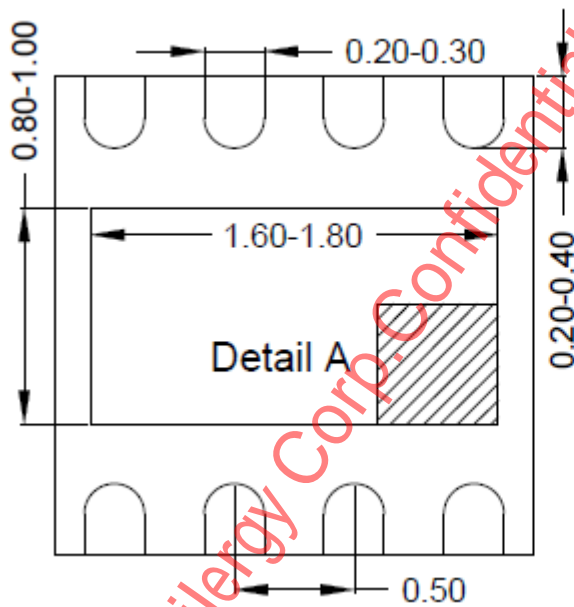

Bottom View

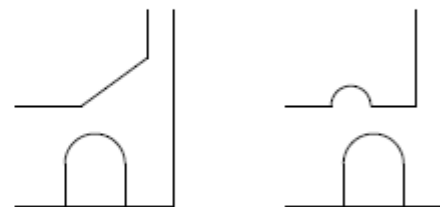

Detail A

Pin1 Identifier(Two options)



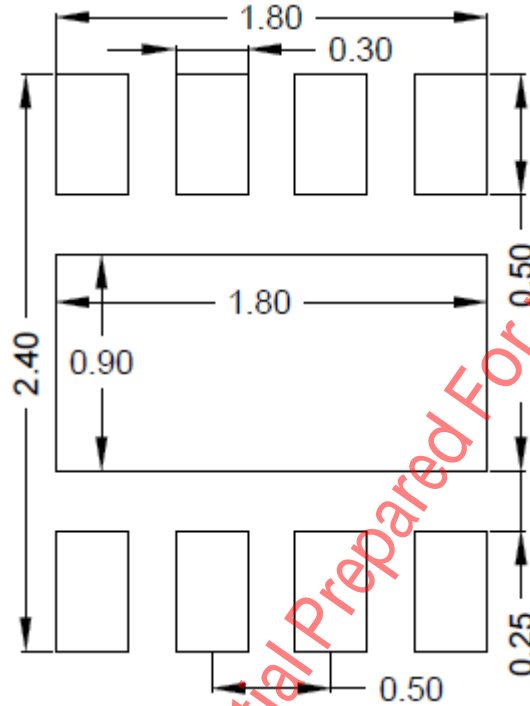

**Recommended PCB layout  
(Reference only)**

**Notes:** All dimension in millimeter and exclude mold flash & metal burr.

## Taping & Reel Specification

### 1. Taping orientation

DFN2x2-8

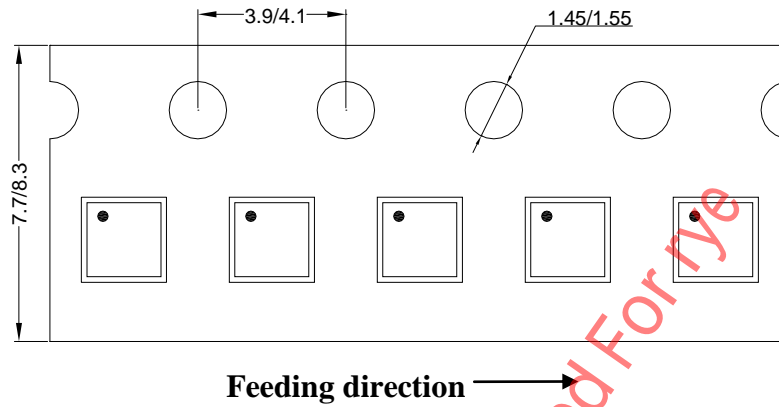

### 2. Carrier Tape & Reel specification for packages

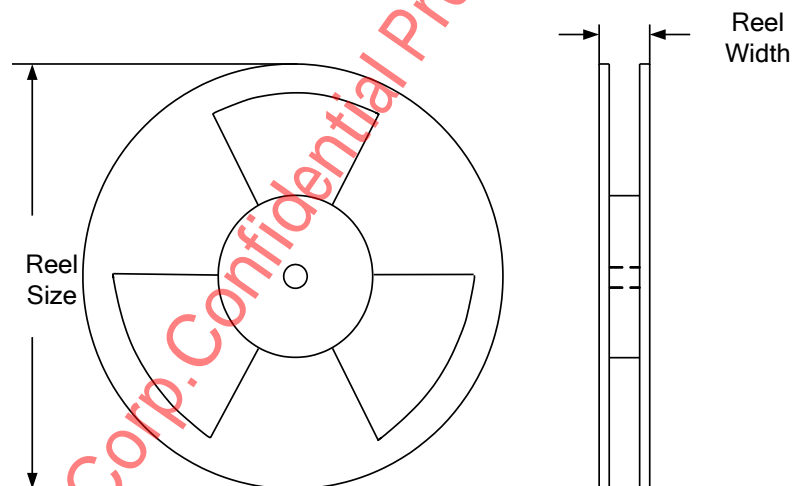

| Package types | Tape width (mm) | Pocket pitch(mm) | Reel size (Inch) | Reel width(mm) | Trailer length(mm) | Leader length (mm) | Qty per reel |
|---------------|-----------------|------------------|------------------|----------------|--------------------|--------------------|--------------|
| DFN2x2        | 8               | 4                | 7"               | 8.4            | 400                | 160                | 3000         |

### 3. Others: NA



## IMPORTANT NOTICE

- 1. Right to make changes.** Silergy and its subsidiaries (hereafter Silergy) reserve the right to change any information published in this document, including but not limited to circuitry, specification and/or product design, manufacturing or descriptions, at any time and without notice. This document supersedes and replaces all information supplied prior to the publication hereof. Buyers should obtain the latest relevant information before placing orders and should verify that such information is current and complete. All semiconductor products are sold subject to Silergy's standard terms and conditions of sale.
- 2. Applications.** Application examples that are described herein for any of these products are for illustrative purposes only. Silergy makes no representation or warranty that such applications will be suitable for the specified use without further testing or modification. Buyers are responsible for the design and operation of their applications and products using Silergy products. Silergy or its subsidiaries assume no liability for any application assistance or designs of customer products. It is customer's sole responsibility to determine whether the Silergy product is suitable and fit for the customer's applications and products planned. To minimize the risks associated with customer's products and applications, customer should provide adequate design and operating safeguards. Customer represents and agrees that it has all the necessary expertise to create and implement safeguards which anticipate dangerous consequences of failures, monitor failures and their consequences, lessen the likelihood of failures that might cause harm and take appropriate remedial actions. Silergy assumes no liability related to any default, damage, costs or problem in the customer's applications or products, or the application or use by customer's third-party buyers. Customer will fully indemnify Silergy, its subsidiaries, and their representatives against any damages arising out of the use of any Silergy components in safety-critical applications. It is also buyers' sole responsibility to warrant and guarantee that any intellectual property rights of a third party are not infringed upon when integrating Silergy products into any application. Silergy assumes no responsibility for any said applications or for any use of any circuitry other than circuitry entirely embodied in a Silergy product.
- 3. Limited warranty and liability.** Information furnished by Silergy in this document is believed to be accurate and reliable. However, Silergy makes no representation or warranty, expressed or implied, as to the accuracy or completeness of such information and shall have no liability for the consequences of use of such information. In no event shall Silergy be liable for any indirect, incidental, punitive, special or consequential damages, including but not limited to lost profits, lost savings, business interruption, costs related to the removal or replacement of any products or rework charges, whether or not such damages are based on tort or negligence, warranty, breach of contract or any other legal theory. Notwithstanding any damages that customer might incur for any reason whatsoever, Silergy' aggregate and cumulative liability towards customer for the products described herein shall be limited in accordance with the Standard Terms and Conditions of Sale of Silergy.
- 4. Suitability for use.** Customer acknowledges and agrees that it is solely responsible for compliance with all legal, regulatory and safety-related requirements concerning its products and any use of Silergy components in its applications, notwithstanding any applications-related information or support that may be provided by Silergy. Silergy products are not designed, authorized or warranted to be suitable for use in life support, life-critical or safety-critical systems or equipment, nor in applications where failure or malfunction of a Silergy product can reasonably be expected to result in personal injury, death or severe property or environmental damage. Silergy assumes no liability for inclusion and/or use of Silergy products in such equipment or applications and therefore such inclusion and/or use is at the customer's own risk.
- 5. Terms and conditions of commercial sale.** Silergy products are sold subject to the standard terms and conditions of commercial sale, as published at <http://www.silergy.com/stdterms>, unless otherwise agreed in a valid written individual agreement specifically agreed to in writing by an authorized officer of Silergy. In case an individual agreement is concluded only the terms and conditions of the respective agreement shall apply. Silergy hereby expressly objects to and denies the application of any customer's general terms and conditions with regard to the purchase of Silergy products by the customer.
- 6. No offer to sell or license.** Nothing in this document may be interpreted or construed as an offer to sell products that is open for acceptance or the grant, conveyance or implication of any license under any copyrights, patents or other industrial or intellectual property rights. Silergy makes no representation or warranty that any license, either express or implied, is granted under any patent right, copyright, mask work right, or other intellectual property right. Information published by Silergy regarding third-party products or services does not constitute a license to use such products or services or a warranty or endorsement thereof. Use of such information may require a license from a third party under the patents or other intellectual property of the third party, or a license from Silergy under the patents or other intellectual property of Silergy.

For more information, please visit: [www.silergy.com](http://www.silergy.com)

© 2018 Silergy Corp.

All Rights Reserved.