



高速光耦
High Speed Photo
Coupler

ATM6XX

Product Data Sheet

AOTE DCC
RELEASE

台湾奥特半导体科技有限公司

TAIWAN AOTE SEMICONDUCTOR TECHNOLOGY CO.,LTD

www.aotesemi.com

概述 Description

ATM600、ATM601、ATM611 内部有一个 850nm 的 AlGaAs LED，其光学耦合到具有选通输出的超高速集成光电检测器。这些器件采用 5 引脚外形封装，符合标准封装外形。

The ATM600 ATM601 ATM611 optocoupler consists of a 850 nm AlGaAs LED, optically coupled to a very high speed integrated photo-detector logic gate with a strobable output. The devices are packaged in a 5-pin small outline package which conforms to the standard footprint.

特性 Features

- 输入-输出隔离电压 ($V_{ISO}=3750\text{ Vrms}$)
High isolation voltage between input and output ($V_{ISO}=3750\text{ Vrms}$)
- 工作温度： $-40^{\circ}\text{C} \sim 85^{\circ}\text{C}$
Operating Temperature: $-40^{\circ}\text{C} \sim 85^{\circ}\text{C}$
- 符合加强绝缘标准
Meet reinforced insulation standards
- 符合安规标准： UL 1577, VDE DIN EN60747-5-5 (VDE 0884-5), CQC11-471543-2022
Meet Safety standard : UL 1577, VDE DIN EN60747-5-5 (VDE 0884-5), CQC11-471543-2022

应用 Applications

- 开关电源，智能电表
Switching power supply, intelligent meter
- 工业控制，测量仪器
Industrial control, measuring instruments
- 办公设备，比如复印机
Office equipment such as copiers
- 家用电器，比如空调、风扇、热水器等
Household appliances: such as air conditioners, fans, water heaters, etc.

真值表 Truth table

LED	VO
OFF	H
ON	L

封装和原理图 Package and Schematic Diagram



SOP5

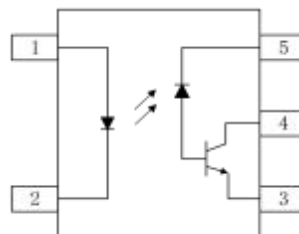

Pin Configuration

1. Anode
2. Cathode
3. GND
4. VO
5. VCC

注：在引脚 3 和 5 之间必须连接一个 0.1uF 的旁路电容器。



Note: 0.1uF bypass capacitor must be connected between pins 3 and 5.

产品型号命名规则 Order Code
AT M6XX - UN Y - W (V) (ZZ)

① ② ③ ④ ⑤ ⑥ ⑦

- ① 公司代码 Company Code (AT: 奥特 Aote)
- ② 产品系列 Product Series (XX: 00, 01, 11)
- ③ 框架类型 Lead Frame (Cu: 铜框架 Copper)
- ④ 树脂类型 Epoxy (H: 无卤 Halogen-free)
- ⑤ 封装形式 Package (S: SOP)
- ⑥ 器件工作温度范围 Device Operating Temperature Range (H:125°C)
- ⑦ 内部补充代码 Internal Supplementary Code (数字或者空白 Number or None)

印字信息 Marking Information

- 印字中 “” 为奥特品牌 LOGO
“” denotes LOGO
- 印字中的 “XX” 代表产品分档：00、01、11
“XX” denotes the classification：00、01、11
- 印字中 “Y” 代表年份；A(2018),B(2019),C(2020)
“Y” denotes YEAR：A(2018), B(2019), C(2020)
- 印字中 “WW” 代表周号
“WW” denotes week’s number
- 印字中 “N” 代表星期几
“N” denotes day of the week
- 印字中的 “H” 代表无卤
“H” denotes Halogen-free



绝缘和安规信息 Insulation and Safety related specifications

项目 Item	符号 Symbol	数值 Value	单位 Unit	备注 Remark
爬电距离 Creepage Distance	L	> 5.0	mm	从输入端到输出端，沿本体最短距离路径 Measured from input terminals to output terminals, shortest distance path along body
电气间隙 Clearance Distance	L	> 5.0	mm	从输入端到输出端，通过空气的最短距离 Measured from input terminals to output terminals, shortest distance through air
绝缘距离 Insulation Thickness	DTI	> 0.4	mm	发射器和探测器之间的绝缘厚度 Insulation thickness between emitter and detector
峰值隔离电压 Peak Isolation Voltage	V_{IORM}	600	V_{peak}	DIN/EN/IEC EN60747-5-5
瞬态隔离电压 Transient isolation voltage	V_{IOTM}	5000	V_{peak}	DIN/EN/IEC EN60747-5-5
隔离电压 Isolation Voltage	V_{iso}	> 3750	Vrms	For 1 min

极限参数 Absolute Maximum Ratings (Ta = 25°C)

参数 Parameter		符号 Symbol	额定值 Rating	单位 Unit
发射端 Input	正向电流 Forward Current	I_F	50	mA
	反向电压 Reverse Voltage	V_R	5	V
	功耗 Power Dissipation	P_D	100	mW
接收端 Output	电源电压 Supply Voltage	V_{CC}	7.0	V
	输出电流 Output Current	I_O	50	mA
	输出电压 Output Voltage	V_O	7.0	V
	集电极功耗 Collector Power Dissipation	P_C	85	mW
工作温度 Operating Temperature		T_{opr}	-40 ~ +125	°C
存储温度 Storage Temperature		T_{stg}	-55 ~ +125	°C
焊接温度 Soldering Temperature		T_{sol}	260	°C

推荐工作条件 Recommended Operating Conditions

参数 Parameter	符号 Symbol	最小值 Min.	最大值 Max.	单位 Unit
电源电压 Supply Voltages	V _{CC}	4.5	5.5	V
高电平输入电流 Input Current , High level	I _{FH}	5	10.0	mA
低电平输入电流 Input Current , Low level	I _{FL}	0	250	μA
操作温度 Operating Temperature	T _a	-40	125	°C

产品特性参数 Electro-optical Characteristics (T_a = 25°C)

参数 Parameter	符号 Symbol	条件 Condition	最小 Min.	典型 Typ.	最大 Max.	单位 Unit	
发射端 Input	正向电压 Forward Voltage	V _F	I _F =10mA	-	1.33	1.8	V
	反向击穿电压 Reverse Breakdown Voltage	BV _R	I _R =10μA	5	-	-	V
	电容 Capacitance	C _{IN}	V=0,f=1MHz	-	70	-	pF
	正向电压的温度系数 Diode Temperature Coefficient	ΔV _F /ΔT _A	I _F =10mA	-	-1.9	-	mV/°C
接收端 Output	高电平电源电流 High Level Supply Current	I _{CCH}	V _{CC} =5.5V ,I _F =0mA	-	6.0	9	mA
	低电平电源电流 Low Level Supply Current	I _{CCL}	V _{CC} =5.5V ,I _F =0mA	-	7.5	10	mA
传输特性 Transfer Characteristics	高电平输出电流 HIGH Level Output Current	I _{OH}	V _{CC} =5.5V V _O =5.5V I _F =250μA	-	2.1	30	μA
	低电平输出电压 LOW Level Output Voltage	V _{OL}	V _{CC} =5.5V I _F =5mA I _{CL} =13mA	-	0.4	0.6	V
	输入阈值电流 Input Threshold Current	I _{TH}	V _{CC} =5.5V V _O =0.6V I _{OL} =13mA	-	2.4	5	mA
隔离电压 Isolation Voltage	V _{ISO}	R _H < 50% T _A = 25°C I _{IO} ≤ 50μA	3750	-	-	V _{RMS}	
电阻 (输入到输出) Resistance (Input to Output)	R _{I-O}	V _{I-O} =500V	-	10 ¹²	-	Ω	
电容 (输入到输出) Resistance (Input to Output)	C _{I-O}	f=1MHz	-	0.6	-	pF	

开关特性 Switching Specification (Ta = 25°C, I_F = 7.5 mA, V_{CC} = 5.0V)

参数 Parameter	符号 Symbol	条件 Condition	最小 Min.	典型 Typ.	最大 Max.	单位 Unit
输出高电平传播延迟 Propagation Delay Time to High Output Level	T _{PLH}	C _L = 15pF R _L = 350Ω T _A = 25°C	-	41	100	ns
输出低电平传播延迟 Propagation Delay Time to Low Output Level	T _{PHL}		-	50	100	ns
脉宽失真 Pulse Width Distortion	T _{PHL} - T _{PLH}		-	9	35	ns
输出上升时间(10% - 90%) Output Rise Time (10 to 90%)	tr		-	40	-	ns
输出下降时间(90% - 10%) Output Fall Time (90 to 10%)	tf		-	10	-	ns
传播延迟偏斜 Propagation Delay Skew	t _{psk}		-	-	40	ns
输出高电平共模瞬态抑制 Common Mode Transient Immunity at High Output Level	M600		T _A = 25°C, I _F = 0mA V _{CM} = 10V(Peak) V _{OH} = 2.0V, R _L = 350Ω	-	-	-
	M601	T _A = 25°C, I _F = 0mA V _{CM} = 50V(Peak) V _{OH} = 2.0V, R _L = 350Ω	5000	-	-	
	M611	T _A = 25°C, I _F = 0mA V _{CM} = 1000V(Peak) V _{OH} = 2.0V, R _L = 350Ω	20000	-	-	
输出低电平共模瞬态抑制 Common Mode Transient Immunity at Low Output Level	M600	I _F = 7.5mA, V _{OL} = 0.8V R _L = 350Ω, T _A = 25°C V _{CM} = 10V(Peak)	-	-	-	V/μs
	M601	I _F = 7.5mA, V _{OL} = 0.8V R _L = 350Ω, T _A = 25°C V _{CM} = 50V(Peak)	5000	-	-	
	M611	I _F = 7.5mA, V _{OL} = 0.8V R _L = 350Ω, T _A = 25°C V _{CM} = 1000V(Peak)	20000	-	-	

典型光电特性曲线 Typical Electro-Optical Characteristics Curves

Fig.1 Low-level voltage vs. Ambient temperature

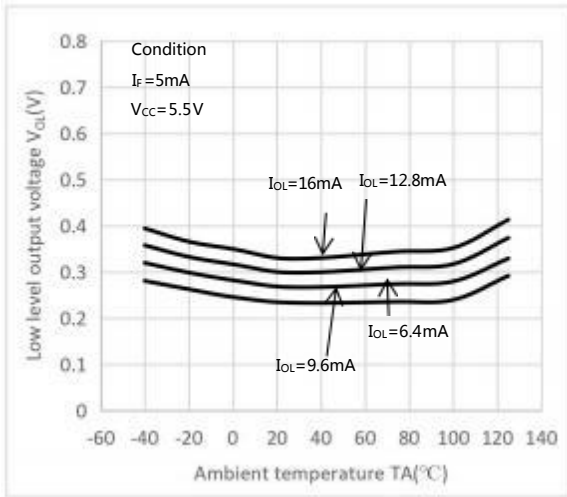

Fig.2 Forward current voltage vs. Forward voltage

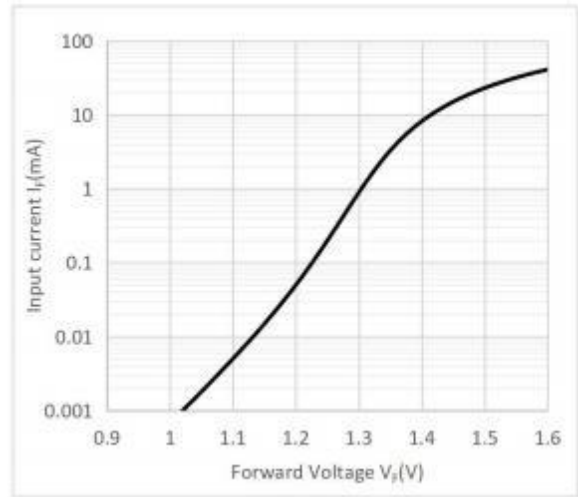

Fig.3 Switch time vs. Forward current

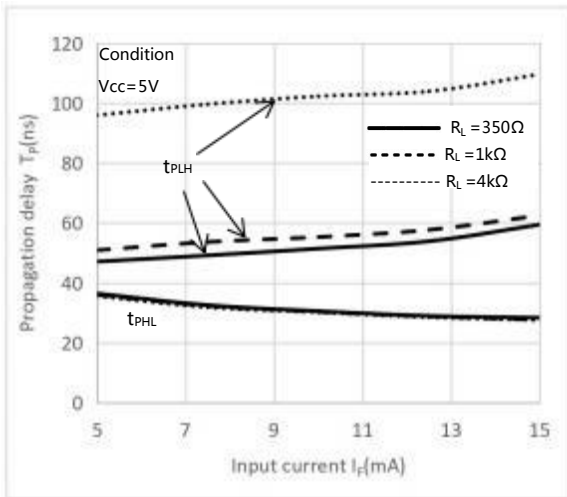

Fig.4 Low-level output current vs. Ambient temperature

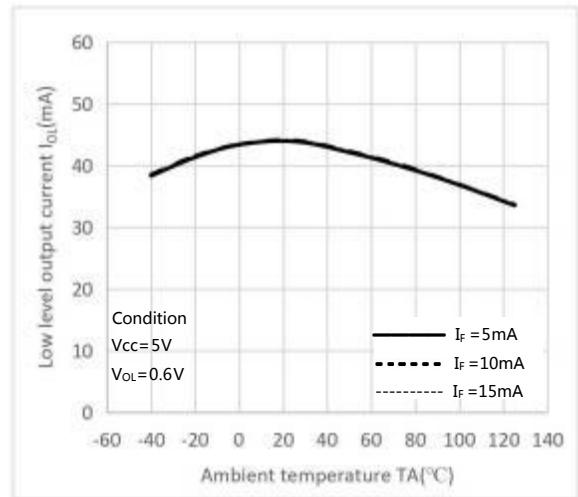

Fig.5 Starting current vs. Ambient temperature

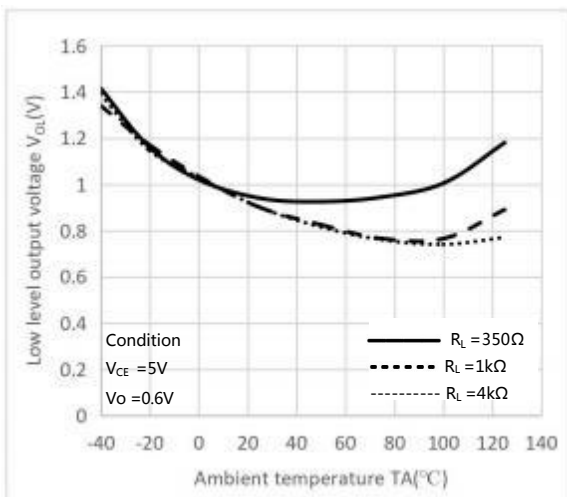

Fig.6 Output voltage vs. Input Forward current

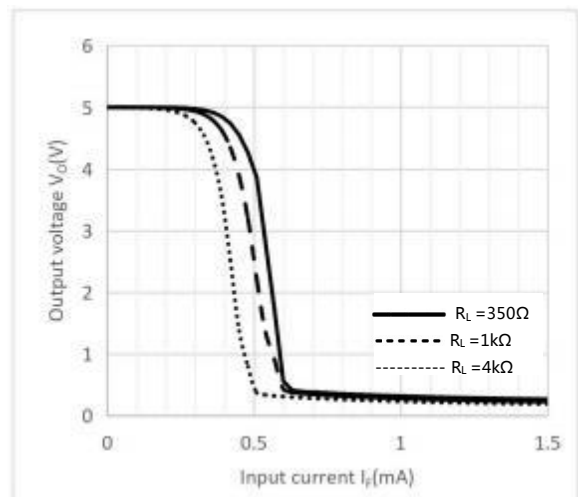

Fig.7 Pulse-width distortion vs. Ambient temperature

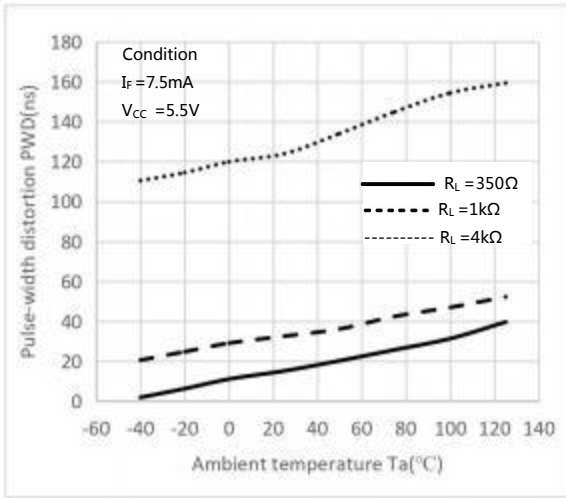

Fig.8 Switch time vs. Ambient temperature

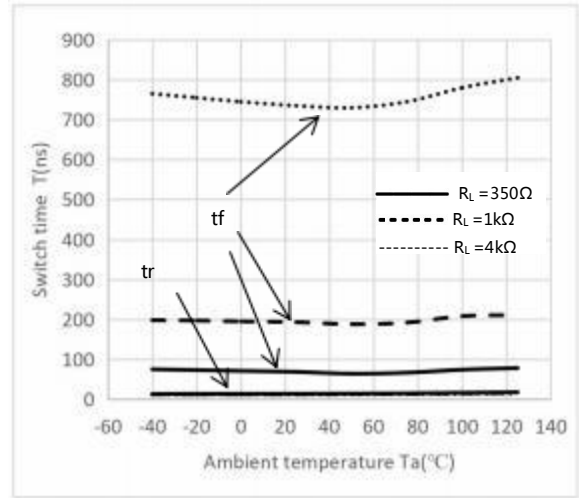

Fig.9 Propagation delay vs. Ambient temperature

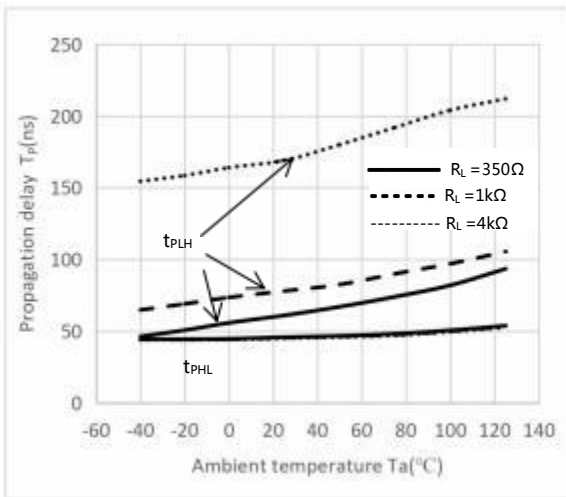
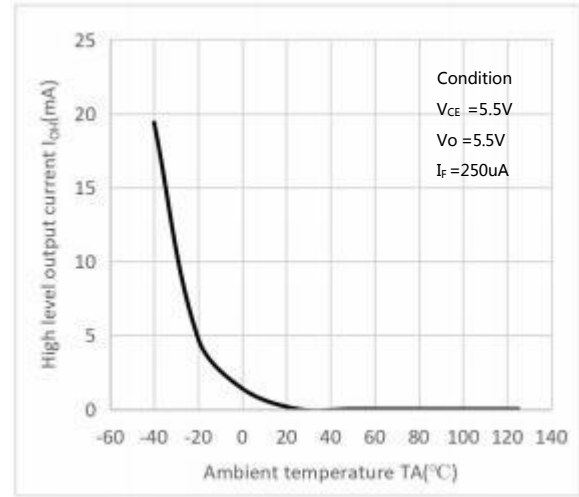
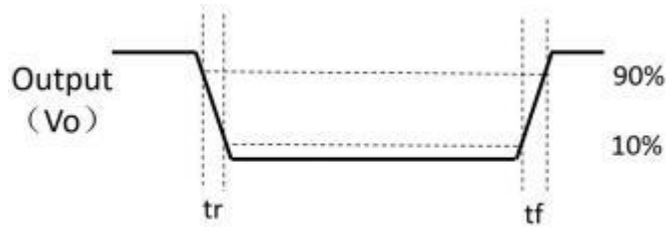
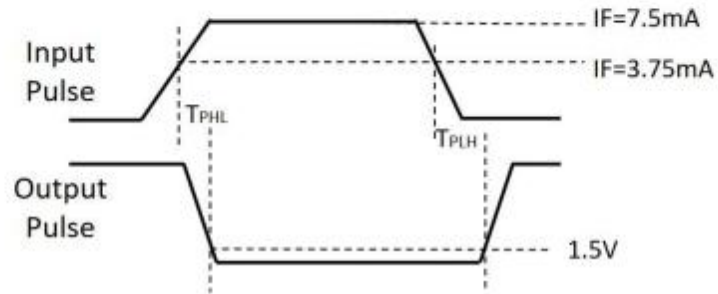
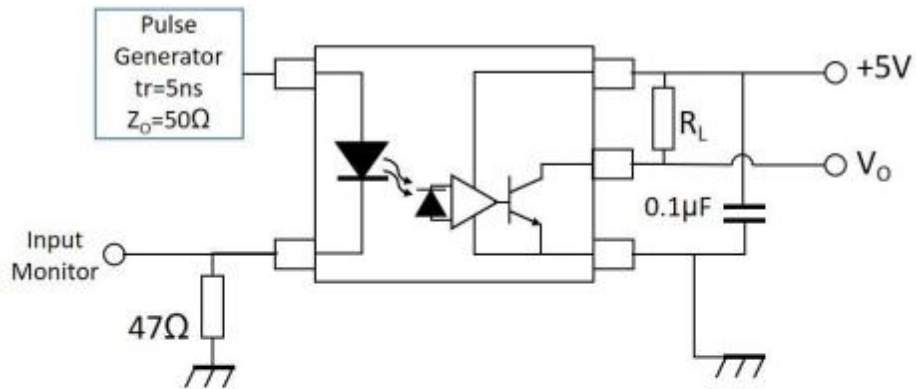

Fig.10 High-level output current vs. Ambient temperature



开关时间测试电路 Witch Time Test Circuit



CMR 测试电路 Test Circuit for Common Mode Transient Immunity

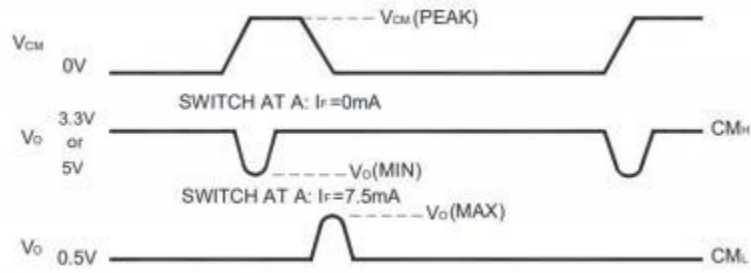
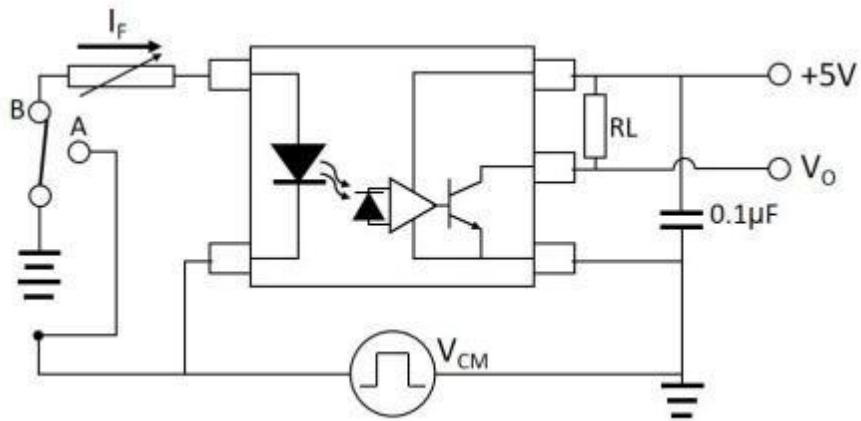

外形尺寸 Outline Dimensions

SOP5

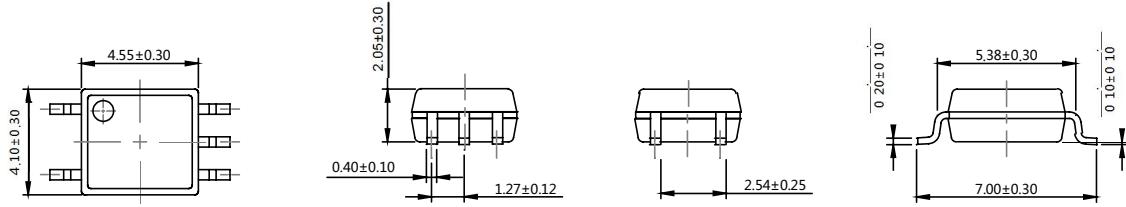

单位 Unit: mm

建议焊盘布局 Recommended Pad Layout

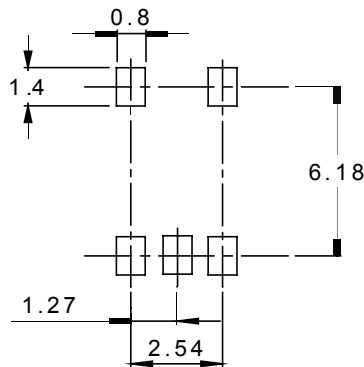

单位 Unit: mm

注：上图为产品正视图。

Note: The picture above is the front view of the product.

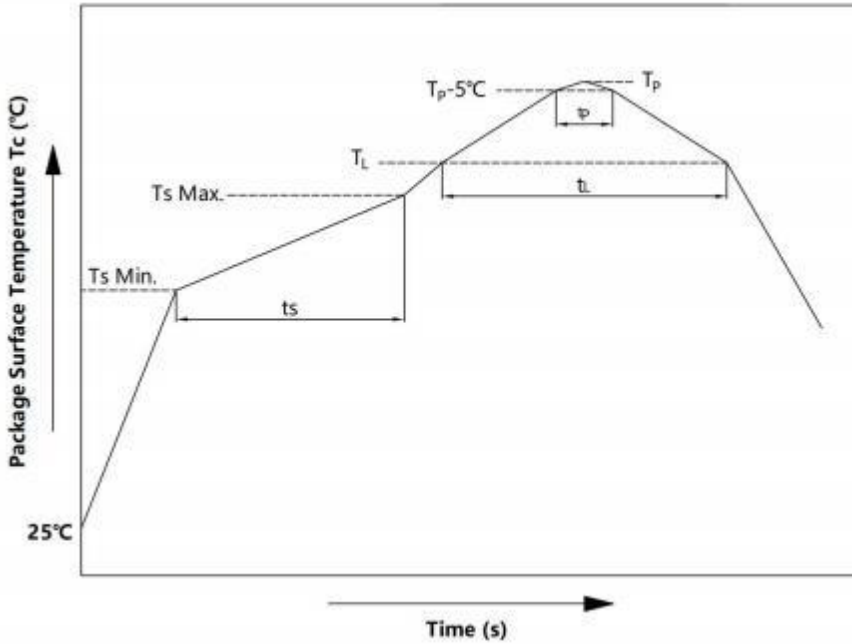
回流焊温度曲线图 Solder Reflow Profile

项目 Item	符号 Symbol	最小值 Min.	最大值 Max.	单位 Unit
预热温度 Preheat Temperature	Ts	150	200	°C
预热时间 Preheat Time	ts	60	120	s
升温速率 Ramp-Up Rate (T _L to T _p)	-	-	3	°C/s
液相线温度 Liquidus Temperature	T _L	217		°C
时间高于 T _L Time Above T _L	t _L	60	150	s
峰值温度 Peak Temperature	T _p	-	260	°C
Tc 在(T _p -5)和 T _p 之间的时间 Time During Which Tc Is Between (T _p -5) and T _p	t _p	-	30	s
降温速率 Ramp-down Rate(T _p to T _L)	-	-	6	°C/s

注 Note :

建议在所示的温度和时间条件下进行回流焊，最多不能超过三次；

Reflow soldering is recommended at the temperatures and times shown, no more than three times;

波峰焊温度曲线图 Wave Soldering Profile

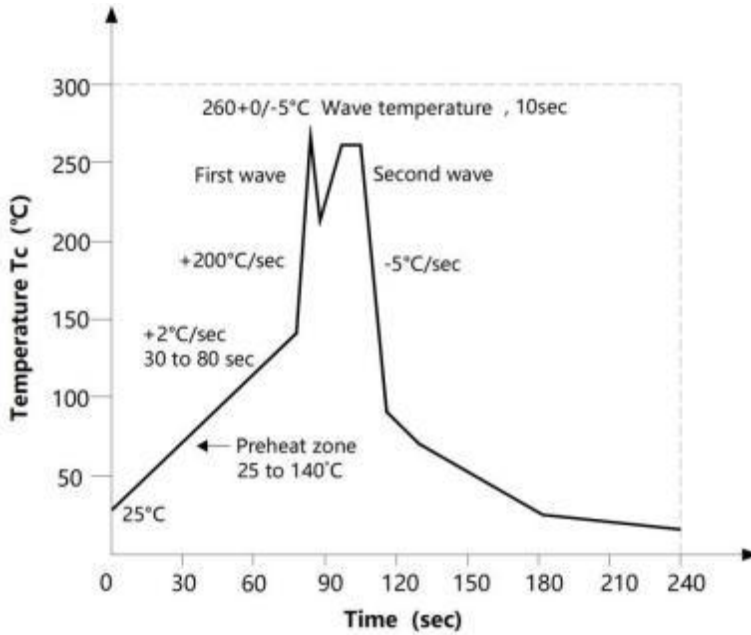

手工烙铁焊接 Soldering with hand soldering iron

- A. 手工烙铁焊仅用于产品返修或样品测试；
Hand soldering iron is only used for product rework or sample testing;
- B. 手工烙铁焊要求：温度 $360^{\circ}\text{C} \pm 5^{\circ}\text{C}$ ，时间 $\leq 3\text{s}$ 。
Hand soldering iron requirements：Temperature： $360^{\circ}\text{C} \pm 5^{\circ}\text{C}$, within 3s.

包装 Packing

■ 汇总表 Summary table

封装形式	包装方式	盘数量	盒数量	箱数量	静电袋规格	盒规格	箱(双瓦楞)规格	备注
SOP5	编带 (φ330mm 蓝)	3k /盘	2 盘/盒	10 盒/箱	450*390*0.1mm	340*60*340mm	620*360*365mm	保护带 200mm (min)
Package Type	Packing Form	Quantity per Reel	Quantity per Box	Quantity per Carton	Antistatic Bag Specification	Box Specification	Carton Specification	Note
SOP5	Reel(φ330mm Blue)	3k pcs/reel	2 reels /box	10 boxes /ctn	450*390*0.1mm	340*60*340mm	620*360*365mm	Guard band 200mm min.

■ 编带包装 Tape & Reel

- 1) 每卷数量：3000 只。
Qty/reel：3000 pcs.
- 2) 每箱数量：60000 只。
Qty/ctn：60000 pcs.
- 3) 内包装：每盒 2 盘。
Inner packing：2 reels/box.
- 4) 示意图 Schematic：

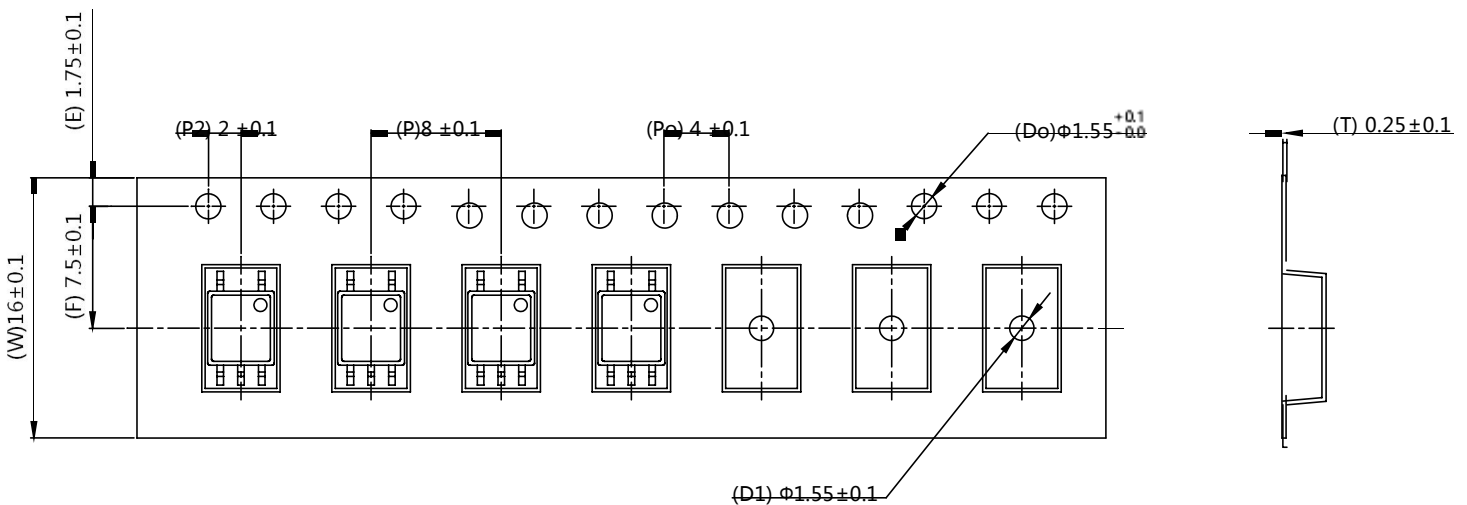

单位 Unit：mm

注意 Attention

- 奥特持续不断改进质量、可靠性、功能或设计，保留此文件更改的权利恕不另行通知。
AOTE continuously improve quality, reliability, function and design. We reserve the right to change this document without prior notice.
- 请遵守产品规格书使用，奥特不对使用时不符合产品规格书条件而导致的质量问题负责。
Please use in accordance with the product specification. AOTE is not responsible for the quality problems caused by non-compliance with the product specifications.
- 对于需要高可靠性或安全性的设备/装置需求，请联系我们的销售人员。
For equipment/devices requiring high reliability or safety, please contact our sales representatives.
- 当需要用于任何“特定”应用时，请咨询我们的销售人员。
When requiring a device for any “specific” application, please contact our sales in advice.
- 如对文件中表述的内容有疑问，欢迎联系我们。
If you have any questions about the contents of the document, please contact us.