

Icron USB 3-2-1 Starling™ 3251C

1-Port USB 3-2-1 Fixed Range Point-to-Point
Extender System

User Guide



Thank you for purchasing the Icron USB 3-2-1 Starling™ 3251C.

Please read this guide thoroughly.

This document applies to the following part numbers:

Model	Distance	Fire Rating	Part Number
Icron USB 3-2-1 Starling 3251C-10	10 meters, 32.8 feet	CM	00-00456
Icron USB 3-2-1 Starling 3251C-10-PL	10 meters, 32.8 feet	Plenum	00-00457

FCC Radio Frequency Interference Statement Warning

This device complies with Part 15 of the FCC rules. Operation is subject to the following two conditions: (1) this device may not cause harmful interference, and (2) this device must accept any interference received including interference that may cause undesired operation.

CE Statement

We, Icron Technologies Corporation, a Maxim Integrated brand, declare under our sole responsibility that the USB 3-2-1 Starling™ 3251C, to which this declaration relates, is in conformity with European Standards EN 55024, EN 55032, EN 61000, EN 62368-1 and RoHS Directive 2011/65/EU + 2015/863/EU.

IC Statement

This Class A digital apparatus complies with Canadian ICES-003 Issue 7.

WEEE Statement

The European Union has established regulations for the collection and recycling of all waste electrical and electronic equipment (WEEE). Implementation of WEEE regulations may vary slightly by individual EU member states. Please check with your local and state government guidelines for safe disposal and recycling or contact your national WEEE recycling agency for more information.

Product Operation and Storage

Please read and follow all instructions provided with this product and operate for intended use only. Do not attempt to open the product casing as this may cause damage and will void warranty. Use only the power supply provided with this product (if applicable). When not in use, product should be stored in a dry location between -20°C and 70°C.

©2021 All rights reserved.
Document #90-01798-A01

Contents

4 Introduction

Product Contents 4

Features 4

The LEX Unit 5

The REX Unit 6

7 Installation Guide

Installing the USB 3-2-1 Starling 3251C Extender System 7

Installing the LEX Unit 7

Connecting the LEX to the REX 7

Installing the REX Unit 8

Checking the Installation 8

Connecting a USB Device 8

Compatibility 8

11 Troubleshooting

13 Warranty Information

14 Specifications

15 Power Supply and Accessories

15 Contacting Technical Support

16 Technical Glossary

Introduction

This guide provides product information for the Icron USB 3-2-1 Starling™ 3251C, installation instructions and troubleshooting guidelines. The instructions in this guide assume a general knowledge of computer installation procedures, familiarity with cabling requirements and some understanding of USB devices.

 NOTE: Notes provide additional information that could be useful.

 CAUTION: Cautions provide important information about an operational requirement.

Product Contents

Your Starling 3251C extender system contains:

- LEX (Local Extender)
- REX (Remote Extender)
- USB 3.2 Gen 1 USB-C Cable (USB only)
- Custom Link Cable (10m, CM or Plenum Rated)
- Cable Pulling Eye
- Quick Start Guide

Features

The Starling 3251C incorporates ExtremeUSB-C™ technology, enabling users to extend USB 3.2 beyond the standard 3m cable limit for USB 3.2 peripheral devices. This extender system is composed of two individual units, the LEX and the REX, and has the following key features:

- 10m extension using included Cable
- Support for new USB 3.2 Gen 1/2 host controllers and devices (up to 5Gbps)
- Bus Powered Operation
- Supports all device types
- Backwards compatible to USB 2.0 devices

 Starling 3251C does NOT support DisplayPort ALT mode functionality through the USB-C connection.

 The Starling models 3251C-10 with CM Cable and 32510C-10-PL with Plenum Cable are not interchangeable. The Plenum model does not work with the CM Cable. The CM model does not work with the Plenum Cable.

The Starling 3251C includes the ExtremeUSB-C™ suite of features:



- Transparent USB extension supporting USB 3, 2 and 1
- True plug and play; no software drivers required
- Works with all major operating systems: Windows®, macOS™, Linux® and Chrome OS™

The LEX Unit

The LEX unit connects to the computer using a standard USB 3.2 Gen 1 cable. Power is provided by the USB Host/Hub or optional DC input.

Front View

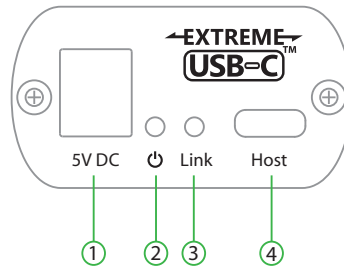

Rear View

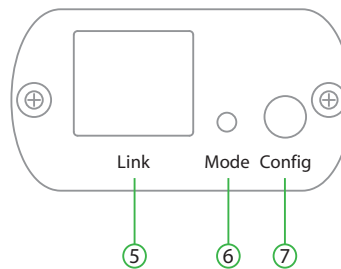

ITEM	TYPE	DESCRIPTION
1	DC Power Port	Optional DC power input, accepts 5V 3A. (Sold separately) Icron PN 21-00111 5V 3A Power Supply (LVL VI) 1.7mm ID.
2	Power LED * <i>Refer to note below</i>	LED is SOLID GREEN When sufficient power is provided by host. LED is SOLID AMBER when less than optimal power is not guaranteed by host.
3	Link LED	LED is SOLID GREEN ON when LEX is linked to an opposite REX. LED is OFF or BLINKING when there is no connection between the LEX and REX units.
4	USB Host Port	USB 3 Type-C receptacle used to connect LEX to USB 3 Host computer.
5	Link Port (ARJ45)	Accepts custom ARJ45 Cable included with product.
6	Mode	Reserved for manufacturer use.
7	Config	Reserved for manufacturer use.



* Guaranteed sufficient power via USB Bus power requires a USB-C connection to a USB-C power upstream capable of 5V 3A configuration. When using a USB-A to USB-C or similar legacy connection, LED will be AMBER. It is recommended in situations where the LED is AMBER that sufficient testing be performed to guarantee system stability.

The REX Unit

The REX unit provides a USB 3.2 Gen 1 Type-C port for standard USB devices and allows you to connect one USB device directly.

Front View

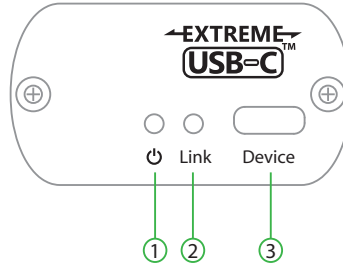

Rear View

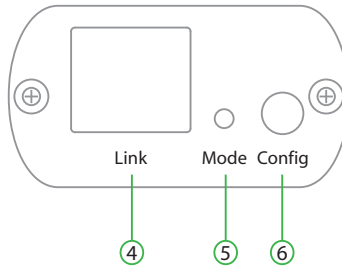

ITEM	TYPE	DESCRIPTION
1	Power LED	LED Is SOLID GREEN when sufficient power is supplied by LEX. LED is SOLID AMBER when less than optimal power is not guaranteed by host.
2	Link LED	LED is SOLID GREEN ON when REX is linked to an opposite LEX. LED is OFF or BLINKING when there is no connection between the LEX and REX units.
3	Device Port	USB 3 Type-C receptacle used to connect REX to USB device.
4	Link Port (ARJ45)	Accepts custom ARJ45 Cable included with product.
5	Mode	Reserved for manufacturer use.
6	Config	Reserved for manufacturer use.



* Guaranteed sufficient power via USB Bus power requires a USB-C connection to a USB-C power upstream capable of 5V 3A configuration. When using a USB-A to USB-C or similar legacy connection, LED will be AMBER. It is recommended in situations where the LED is AMBER that sufficient testing be performed to guarantee system stability.

Installation Guide

Installing the USB 3-2-1 Starling 3251C Extender System

To complete the installation, you will also require the following items that are not included with this system:

- USB compatible computer (host computer) with a USB compliant operating system
- USB compatible device(s)

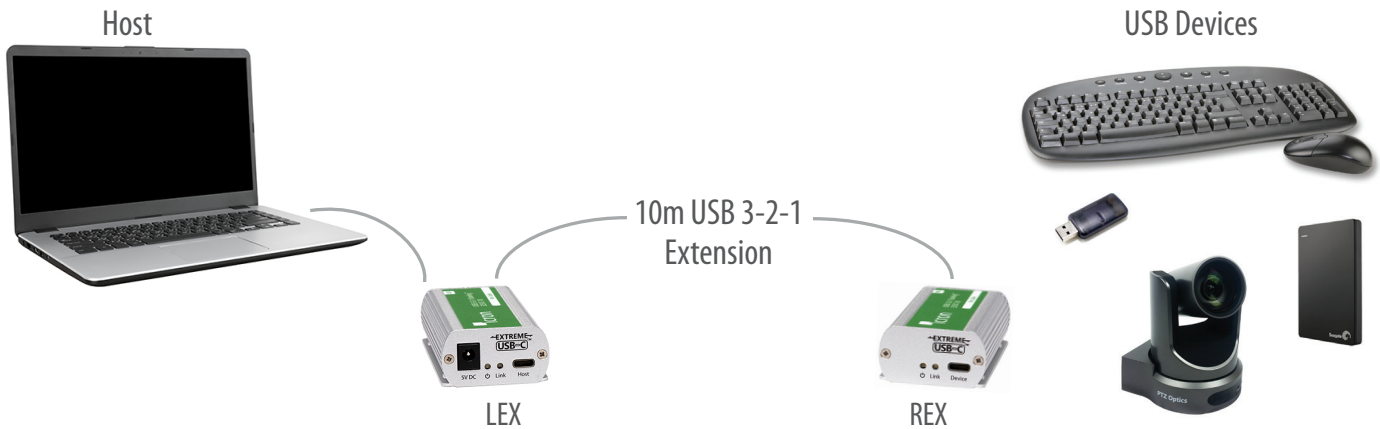

Preparing Your Site

Before installing the Starling 3251C extender, you will need to prepare your site:

1. Place the computer where desired and set it up.
2. Ensure to locate your USB device(s) within the cable-length of the computer. If not, adjust the location of your device(s) and/or computer accordingly.

! Cable installation is important, particularly if high throughput applications are used. When installing, ensure the cable is installed away from, or isolated from potential sources of interference such as electrical wiring, fluorescent lighting, etc.

note Use the included ARJ45 Cable Pulling Eye tool when installing included cable through conduits or other tight spaces.

note Use only the included cable with this product; do not cut or re-size the included cable.

Installing the LEX Unit

1. Place the LEX unit near the computer.
2. Optional: Apply 5V 3A AC power supply to unit. (Sold separately)
3. Connect the supplied USB 3.2 Gen 1 cable between the LEX host port and a USB 3 port on the host computer.
4. If the Power LED is AMBER, test the system with the connected device(s) to ensure system is stable. If not a 5V 3A power supply may be required.

Connecting the LEX to the REX

1. Plug one end of the included Cable into the Link port on the LEX.
2. Plug the other end of the included cable into the Link port on the REX.

Installing the REX Unit

1. Place the REX near and connect it to the USB device.

Checking the Installation

1. On the LEX and REX units, check that the Power and Link LEDs are on. If the Link LEDs are permanently off or blinking, then the cable between the LEX and REX units may not be installed properly or is defective.
2. For Windows users (7, 8, 8.1, 10), open Device Manager to confirm that the extender system has been installed correctly. Expand the entry for Universal Serial Bus controllers by clicking the "+" sign. If the extender system has been installed correctly, you should find only one instance of "Generic SuperSpeed USB Hub" listed.

To open Device Manager in Windows 7:

Open the Start Menu, right click on "Computer" then select: Manage >> Device Manager

To open Device Manager in Windows 8, 8.1 or 10:

Right click the Start Menu and then select: Device Manager

3. For macOS users, open the System Profiler to confirm that the extender system has installed correctly. In the left-hand column under Hardware, select "USB" and inspect the right-hand panel. If the extender has been installed correctly, you should find it listed as one instance of "Hub" under the USB SuperSpeed Bus.



To open System Profiler in macOS:

Open the Finder, select Applications, then open the Utilities folder and double click on the System Profiler icon.

4. If the extender system is not detected correctly or fails to detect, please consult the Troubleshooting section in this guide.

Connecting a USB Device

1. Install any software required to operate the USB device. Refer to the documentation for the USB device, as required.
2. Connect the USB device to the device port on the REX.
3. Check that the device is detected and installed properly in the operating system.

Compatibility

The USB 3-2-1 Starling 3251C complies with USB 1.1, USB 2.0 and USB 3.2 Gen 1 specifications governing the design of USB devices. However, there is no guarantee that all USB devices or hosts will be compatible as there are a number of different characteristics that may impact the operation of USB devices over extended distances. USB Bus power operation is only guaranteed with USB-C Upstream facing port connections with a USB-C cable.

Optional USB Extender Mounting Options

The bottom of the Starling 3251C enclosure features four convenient pre-drilled holes for optional direct surface mounting and four mounting slots for easy cable-ties. Based on your requirements, choose from three available mounting options:

1. **USB Extender Mounting Kit**
2. **USB Extender Direct Surface Mounting**
3. **USB Extender Cable-Tie Mounting**

Option 1: USB Extender Mounting Kit

Order Part #21-00155 for **Starling Starling USB Mounting Kit** is available for purchase separately, and only one kit is required per extender system.

Each kit includes:

- 4 mounting brackets
- 8 (M2.5x4.5mm) Phillips raised cheese head screws with lock and flat washers
- Mounting bracket installation guide (*refer to diagram below*)

Using a Phillips screwdriver, in the order as illustrated below, fasten and secure the provided screws into place.

Installing the Mounting Brackets

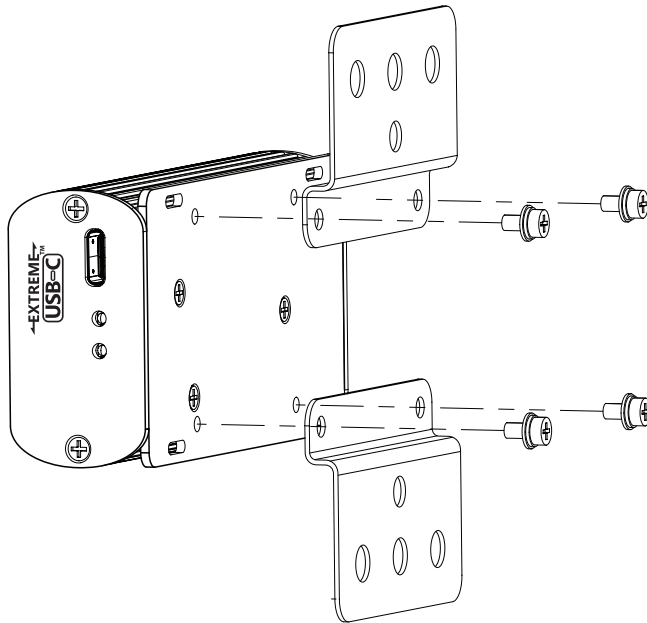

OPTION 2: USB Extender Direct Surface Mounting (using your own hardware)

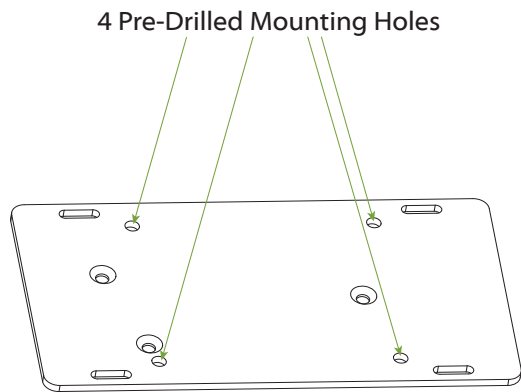

The bottom of the Starling 3251C enclosure features four pre-drilled holes for optional direct surface mounting. Using the stencil below, along with your own hardware you can directly mount your USB Extender on a surface.

Distance between the enclosure mounting holes:
42.00 x 33.70mm

1. Mark the center point of each of the four holes on your mounting surface either by directly measuring or using a printout of the stencil below.
2. Hardware recommendation: M2.5 locking washers and M2.5 screws (4 of each per extender) noting screw length will depend upon thickness of mounting surface.
3. Drill through each of the four-hole markings on the mounting surface using a 3.70mm (0.1457") drill bit.
4. Align the bottom enclosure holes to the newly drilled out holes on the mounting surface.
5. Place a locking washer on each of the four screws and using a screwdriver, fasten the extender into place.

note To ensure the stencil below prints to scale be sure to set the page scaling setting to "none".

Direct Surface Mounting Measurement Stencil

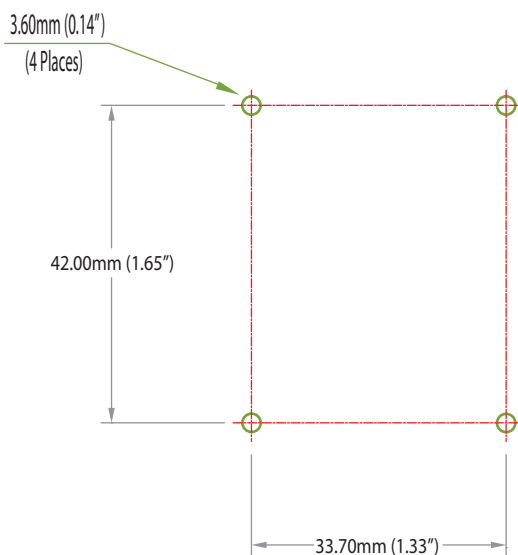

Option 3: Cable-Tie Mounting

The bottom of the Starling 3251C enclosure also features four convenient slots for cable mounting. Simply thread a cable tie, (also called tie-wrap or zip tie), into the mounting slot and through the cable tie head and secure it to a pole or other surface by pulling it tight. Cable ties are not included with this system due to varying lengths dependent upon the application.

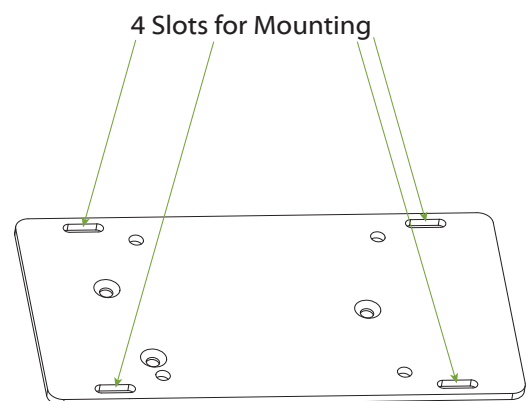

Troubleshooting

The following table provides troubleshooting tips. The topics are arranged in the order in which they should be executed in most situations. If you are unable to resolve the problem after following these instructions, please contact Icron [Technical Support](#) for further assistance.

PROBLEM	CAUSE	SOLUTION
ALL LEDs are OFF on the LEX and/or REX.	<ol style="list-style-type: none"> 1. The LEX and/or REX is not receiving power from the AC power adapter. 2. The LEX is not connected to a host. 	<ol style="list-style-type: none"> 1. Ensure that the AC power adapter is properly connected to the LEX and/or REX. 2. Check that the AC adapter is connected to a live source of AC power. Check that the LEX and/or REX Power LED is illuminated.
Link LEDs on the LEX and REX are OFF or BLINKING.	<ol style="list-style-type: none"> 1. There is no connection between the LEX and REX units. 	<ol style="list-style-type: none"> 1. Ensure that the included cable is connected securely between the LEX and REX.
ALL LEDs on both the LEX and REX units are SOLID ON, but the USB device is not operating correctly, or is detected as an "Unknown Device" in the operating system.	<ol style="list-style-type: none"> 1. The USB device is malfunctioning. 2. The computer does not recognize the USB device. 3. The application software for the USB device is not operating. 4. The USB extender is malfunctioning. 	<ol style="list-style-type: none"> 1. Disconnect the extender from the computer. 2. Connect the USB device directly to the host computer. 3. If the device does not operate as expected, consult the user documentation for the device. 4. Update the host computer BIOS, chipset, or USB controller drivers from the manufacturer's website. 5. If the device operates as expected when directly connected to the computer, connect another device to the extender and reconnect it to the host computer. If the device still does not work, please contact Technical Support for assistance.
A USB 3 device is not enumerating as USB 3, or the operating system is notifying the user that the device can "Perform Faster if connected to a USB 3 port".	<ol style="list-style-type: none"> 1. The USB device is malfunctioning. 2. The computer does not recognize the USB device. 3. The application software for the USB device is not operating. 4. The USB 3 port on the computer is malfunctioning. 5. The USB extender is malfunctioning. 	<ol style="list-style-type: none"> 1. Disconnect the extender from the computer. 2. Connect the USB 3 device directly to the host computer. 3. If the device does not operate as expected as a USB 3 device, consult the user documentation for that device or try a different USB port on the host computer. 4. Update the host computer BIOS, chipset or USB controller drivers from the manufacturer's website. 5. If the device operates as USB 3 device when directly connected to the computer, connect another USB 3 device to the extender and reconnect it to the host computer. If the device still does not work, please contact Technical Support for assistance.

PROBLEM	CAUSE	SOLUTION
Power LED is Solid Amber.	1. Upstream USB connection does not advertise 5V 3A connectivity.	<ol style="list-style-type: none">1. Ensure connection is made to an upstream USB-C port (Not Type A or B).2. Switch to a different port.3. Solution may not require all 900mA to operate. Test complete setup.4. Install Optional Power Supply. (Sold separately)5. If not working, please contact Technical Support for assistance.

Warranty Information

Limited Hardware Warranty

Icron Technologies Corporation, a Maxim Integrated brand, warrants that any hardware products accompanying this documentation shall be free from significant defects in material and workmanship for a period of **two years from the date of purchase**. Icron's hardware warranty extends to Licensee, its customers and end users.

The Warranty does not include repair of failures caused by misuse, neglect, accident, modification, operation outside a normal operating environment, failure caused by service of the device by non-authorized servicers, or failure caused by a product for which Icron is not responsible. Opening the enclosures will void warranty.

Hardware Remedies

Icron's entire liability and the Licensee's exclusive remedy for any breach of warranty shall be, at Icron's option, either (a) return of the price paid or (b) repair or replacement of hardware, which will be warranted for the remainder of the original warranty period or 30 days, whichever is longer. These remedies are void if failure of the hardware has resulted from accident, abuse, or misapplication.

Limitation of Liability

The hardware warranty set forth in this agreement replaces all other warranties. Icron expressly disclaims all other merchantability and fitness for a particular purpose and noninfringement of third-party rights with respect to the hardware.

Icron dealer, agent, or employee is not authorized to make any modification extension or addition to this warranty. Under no circumstances will Icron, its suppliers or licensors be liable for any costs of procurement or substitute products or services, lost profits, loss of information or data, or any other special, indirect, consequential, or incidental damages arising in any way out of the sale of, use of, or inability to use Icron product or service, even if Icron, its suppliers or licensors have been advised of the possibility of such damages. In no case shall Icron, its suppliers and licensors' liability exceed the actual money paid for the products at issue.

Since some jurisdictions do not allow the limitation of implied warranties of liability for incidental, consequential, special, or indirect damages, the above limitation may not always apply. The above limitation will not apply in case of personal injury where and to the extent that applicable law requires such liability.

Obtaining Warranty Service

To obtain warranty service, you must first contact Icron within the warranty period for a Return Material Authorization (RMA) number. Icron will not accept returns without an authorized RMA number. Prior to contacting Icron, be sure you have recorded the serial numbers of the LEX and REX. Package the product appropriately for safe shipment and mark the RMA number on the outside of the package. The package must be sent prepaid to Icron Technologies Corporation. We recommend that you insure it or send it by a method that provides package tracking. The repaired or replaced item will be shipped to you, at Icron's expense, not later than thirty days after Icron receives the defective product.

Specifications

RANGE	
Point-to-Point	10m using included Cable
USB DEVICE SUPPORT	
Maximum Throughput	5Gbps
Traffic Types	All Traffic Types
Device Types	All Device Types
Maximum Number of Devices and/or Hubs	30, including Hubs
LOCAL EXTENDER (LEX)	
USB Connector	1 x USB 3.2 Gen 1 Type-C Receptacle
Link Connector	1 x ARJ45 "LINK"
Dimensions	86.0 x 45.0 x 24.0mm (3.4" x 1.8" x 0.9")
Enclosure Material	Silver Anodized Aluminum
Power Supply	Optional 5V 3A (not included, sold separately)
Maximum Wattage	15W (5V 3A) USB or Self-Powered
REMOTE EXTENDER (REX)	
USB Connector	1x USB 3.2 Gen 1 Type-C Receptacle
Link Connector	1 x ARJ45 "LINK"
Dimensions	86.0 x 45.0 x 24.0mm (3.4" x 1.8" x 0.9")
Enclosure Material	Silver Anodized Aluminum
Available Current	Up to 900mA
ENVIRONMENTAL	
Operating Temperature Range	0°C – 50°C (32°F – 122°F)
Storage Temperature Range	-20°C – 70°C (-4°F – 158°F)
Operating Humidity	20% to 80% relative humidity, non-condensing
Storage Humidity	10% to 90% relative humidity, non-condensing
COMPLIANCE	
EMC	FCC (Class A), CE (Class A)
Environmental	RoHS2/3 (CE)
SUPPORT	
Warranty	2-year

Power Supply and Accessories

Ordering Information:

PART #	NAME	DESCRIPTION
21-00111	5V 3A Power Adapter (Level VI) 1.7mm ID	AC Desktop Adapter, 5V 3A, Lvl6, Intl, 1.7mm (ID) plug, IEC320-C7/C8 2-pin
21-00115	NA Ungrounded Power Cord	Cable Power IEC320-C7/C8 1.83m 2-pin NA
21-00116	EU Ungrounded Power Cord	Cable Power IEC320-C7/C8 1.83m 2-pin EU
21-00117	UK Ungrounded Power Cord	Cable Power IEC320-C7/C8 1.83m 2-pin UK
21-00118	AU Ungrounded Power Cord	Cable Power IEC320-C7/C8 1.83m 2-pin AU
21-00109	JP Ungrounded Power Cord	Cable Power IEC320-C7/C8 1.5m 2-pin JP

Contacting Technical Support

If you are experiencing problems not referenced in the Troubleshooting section, contact **Icron Technical Support**:

www.icron.com/support

Tel: +1 604 638 3939

To help us serve you better, please include the following information with your technical support request:

- Host computers make and model
- Type of Operating System installed (e.g. Windows 10, macOS 11.1, etc.)
- Part number and serial number for both the LEX and REX units
- Make and model of any USB device(s) attached to this extender system
- Description of the installation such as Host computer model, transmission media used and information about the USB device(s)
- Description of the problem

Address the returned product to:

RMA Coordinator
Icron Technologies Corporation
4664 Lougheed Highway, Suite 221
Burnaby, BC Canada
V5C 5T5

Contacting Sales

Email: IcronSales@MaximIntegrated.com

Tel: +1 604 638 3920

Technical Glossary

USB 3 and USB 2.0 Cables

USB cables have two distinct full-sized connectors. The Type A connector is used to connect the cable from a USB device to the Type A port on a computer or hub. The Type B connector is used to attach the USB cable to a USB device.

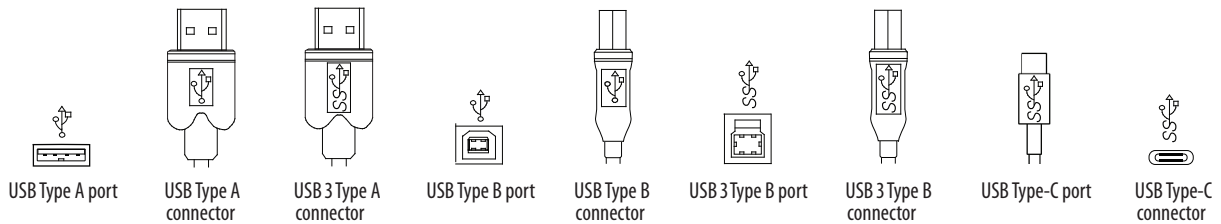

USB-C Cable

The Type-C Connector is used to connect to both USB Hosts and Devices.

ARJ45 Cables

Starling 3251C uses a custom cable assembly based on CAT 7 Cable and leverages an ARJ45 Connection. ARJ45 is a high speed (40Gbps) connection that provides superior cross talk performance when compared to a standard RJ45. The ARJ45 Receptacle is keyed and does not allow RJ45 connections.

- ! ARJ45 Cables cannot be terminated in the field and must be done at the factory. Icron does not recommend or guarantee operation with any cable other than the one included with this product.



A Maxim Integrated Brand

Icron Technologies Corporation
4664 Lougheed Highway, Suite 221
Burnaby, BC Canada
V5C 5T5

Tel: +1 604 638 3920
www.icron.com/contact
www.icron.com