

***8-Bit Bidirectional Voltage-Level Translator with
Auto Direction Sensing and $\pm 15\text{kV}$ ESD Protection***

UM3308/UM3308H CSP20 2.4×1.9

UM3308UK TSSOP20

UM3308QA QFN20 4.5×3.5

UM3308QB QFN20 3.0×3.0

General Description

UM3308/UM3308H/UM3308UK/UM3308QA/UM3308QB is an 8-channel bidirectional voltage level translator with auto direction sensing and $\pm 15\text{kV}$ ESD protection. This 8-channel non-inverting translator uses two separate configurable power-supply rails. The A port is designed to track V_{CCA} . V_{CCA} accepts any supply voltage from 1.2V to 3.6V. The B port is designed to track V_{CCB} . V_{CCB} accepts any supply voltage from 1.65V to 5.5V. This allows for universal low-voltage bidirectional translation between any of the 1.2V, 1.5V, 1.8V, 2.5V, 3.3V, and 5V voltage nodes. Both I/O ports are auto-sensing; thus, no direction pin is required, making it ideal for data transfer between low-voltage ASICs/PLDs and higher voltage systems.

The UM3308/UM3308H/UM3308UK/UM3308QA/UM3308QB operates at a guaranteed data rate of 20Mbps over the entire specified operating voltage range. Within specific voltage domains, higher data rates are up to 100Mbps.

When the output-enable (OE) input is low, all outputs are placed in the high-impedance state. The UM3308/UM3308H/UM3308UK/UM3308QA/UM3308QB is designed so that the OE input circuit is supplied by V_{CCA} .

To ensure the high-impedance state during power up or power down, OE should be tied to GND through a pull down resistor; the minimum value of the resistor is determined by the current-sourcing capability of the driver.

The UM3308 and UM3308H are both available in CSP20 2.4×1.9 BGA package while the UM3308H specially features in wafer backside coating process, minimize chip breakage risk. The UM3308UK is available in TSSOP20 package, the UM3308QA is available in QFN20 4.5×3.5 package and the UM3308QB is available in QFN20 3.0×3.0 package.

Applications

- Low-Voltage ASIC Level Translation
- Cell-Phone Cradles
- Portable POS Systems
- Portable Communication Devices
- Low-Cost Serial Interfaces
- Cell-Phones
- GPS
- Telecommunications Equipment

Features

- 1.2V to 3.6V on A Port and 1.65V to 5.5V on B Port ($V_{CCA} \leq V_{CCB}$)
- V_{CC} Isolation Feature – If Either V_{CC} Input is at GND, All Outputs are in the High-Impedance State
- OE Input Circuit Referenced to V_{CCA}
- Low Power Consumption
- Latch-Up Performance Exceeds 100mA
- $\pm 15\text{kV}$ ESD Protection on B Ports

Pin Configurations

Top View

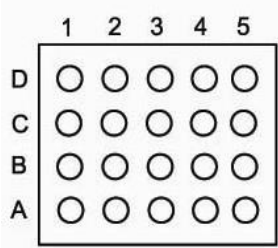
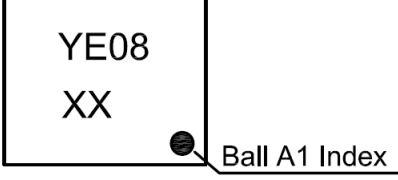
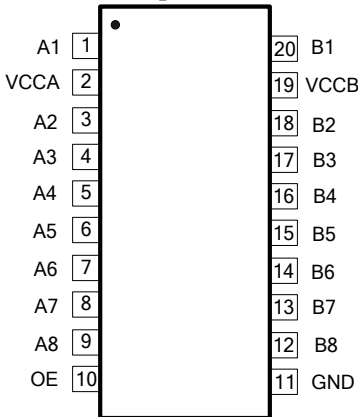
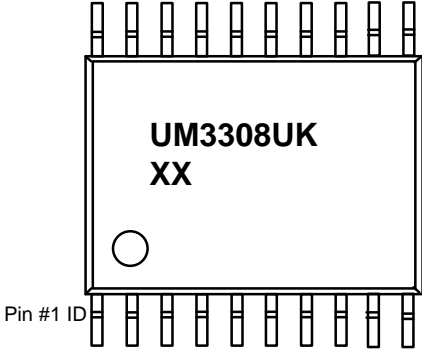
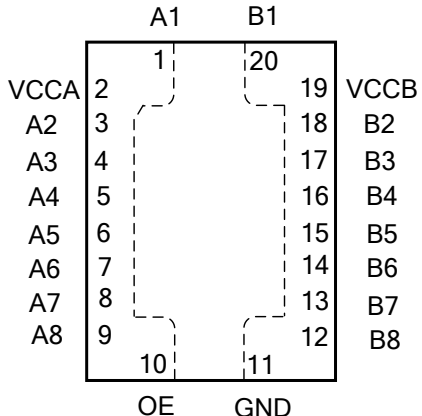
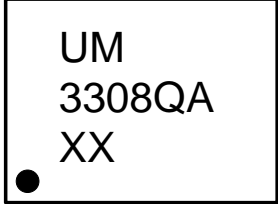
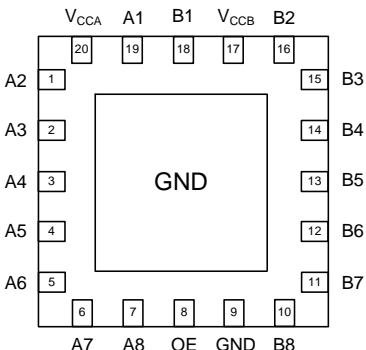
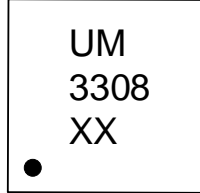
<p align="center">(Bottom View)</p> 	 <p align="center">XX: Date Code UM3308/UM3308H CSP20 2.4x1.9</p>
<p align="center">(Top View)</p> 	 <p align="center">XX: Week Code UM3308UK TSSOP20</p>
<p align="center">(Top View)</p> 	 <p align="center">XX: Week Code UM3308QA QFN20 4.5x3.5</p>
<p align="center">(Top View)</p> 	 <p align="center">XX: Week Code UM3308QB QFN20 3.0x3.0</p>

Ball Mapping for UM3308/UM3308H

	5	4	3	2	1
D	B8	B6	B4	B2	V _{CCB}
C	GND	B7	B5	B3	B1
B	OE	A7	A5	A3	A1
A	A8	A6	A4	A2	V _{CCA}

Transparent Top View
Pin Description

Pin Name	Function
A1	Input/Output 1. Referenced to V _{CCA}
V _{CCA}	A-Port Supply Voltage. $1.1V \leq V_{CCA} \leq 3.6V$ and $V_{CCA} \leq V_{CCB}$
A2	Input/Output 2. Referenced to V _{CCA}
A3	Input/Output 3. Referenced to V _{CCA}
A4	Input/Output 4. Referenced to V _{CCA}
A5	Input/Output 5. Referenced to V _{CCA}
A6	Input/Output 6. Referenced to V _{CCA}
A7	Input/Output 7. Referenced to V _{CCA}
A8	Input/Output 8. Referenced to V _{CCA}
OE	3-State Output Enable. Pull OE low to place all outputs in 3-state mode. Referenced to V _{CCA}
GND	Ground
B8	Input/Output 8. Referenced to V _{CCB}
B7	Input/Output 7. Referenced to V _{CCB}
B6	Input/Output 6. Referenced to V _{CCB}
B5	Input/Output 5. Referenced to V _{CCB}
B4	Input/Output 4. Referenced to V _{CCB}
B3	Input/Output 3. Referenced to V _{CCB}
B2	Input/Output 2. Referenced to V _{CCB}
V _{CCB}	B-Port Supply Voltage. $1.65V \leq V_{CCB} \leq 5.5V$
B1	Input/Output 1. Referenced to V _{CCB}

Ordering Information

Part Number	Packaging Type	Marking Code	Shipping Qty
UM3308	CSP20 2.4×1.9	YE08	3000pcs/7Inch Tape & Reel
UM3308H			
UM3308UK	TSSOP20	UM3308UK	3000pcs/13Inch Tape & Reel
UM3308QA	QFN20 4.5×3.5	UM3308QA	3000pcs/13Inch Tape & Reel
UM3308QB	QFN20 3.0×3.0	UM3308QB	3000pcs/13Inch Tape & Reel

Absolute Maximum Ratings (Note 1)

Over operating free-air temperature range (unless otherwise noted)

Symbol	Parameter	Value	Unit
V _{CCA}	Supply Voltage Range	-0.5 to +4.5	V
V _{CCB}	Supply Voltage Range	-0.5 to +6.5	V
V _I	Input Voltage Range (Note 2)	A ports	-0.5 to +4.5
		B ports	-0.5 to +6.5
V _O	Voltage Range Applied to Any Output in the High-Impedance or Power-Off State (Note 2)	A ports	-0.5 to +4.5
		B ports	-0.5 to +6.5
V _O	Voltage Range Applied to Any Output in the High or Low State (Note 2, 3)	A ports	-0.5 to (V _{CCA} +0.5)
		B ports	-0.5 to (V _{CCB} +0.5)
I _{IK}	Input Clamp Current	V _I <0	-50
I _{OK}	Output Clamp Current	V _O <0	-50
I _O	Continuous Output Current		±50
	Continuous Current through V _{CCA} , V _{CCB} , or GND		±100
T _{OP}	Operating Temperature Range		-40 to +85
T _{STG}	Storage Temperature Range		-65 to +150

Note 1: Stresses beyond those listed under "absolute maximum ratings" may cause permanent damage to the device. These are stress ratings only, and functional operation of the device at these or any other conditions beyond those indicated under "recommended operating conditions" is not implied. Exposure to absolute-maximum-rated conditions for extended periods may affect device reliability.

Note 2: The input and output negative-voltage ratings may be exceeded if the input and output current ratings are observed.

Note 3: The value of V_{CCA} and V_{CCB} are provided in the recommended operating conditions table.

Recommended Operating Conditions (Note 1, 2)

Symbol	Parameter	V _{CCA}	V _{CCB}	Min	Max	Unit
V _{CCA}	Supply Voltage			1.2	3.6	V
V _{CCB}				1.65	5.5	V
V _{IH}	High Level Input Voltage	Data Inputs	1.2V to 3.6V	1.65V to 5.5V	V _{CCI} ×0.65(Note3)	V _{CCI}
		OE	1.2V to 3.6V	1.65V to 5.5V	V _{CCA} ×0.65	5.5
V _{IL}	Low Level Input Voltage	Data Inputs	1.2V to 5.5V	1.65V to 5.5V	0	V _{CCI} ×0.35
		OE	1.2V to 3.6V	1.65V to 5.5V	0	V _{CCA} ×0.35
Δt/ΔV	Input Transition Rise or Fall Time	A-Port Inputs	1.2V to 3.6V	1.65V to 5.5V		40
		B-Port Inputs	1.2V to 3.6V	1.65V to 3.6V		40
				4.5V to 5.5V		30

Note 1: The A and B sides of an unused data I/O pair must be held in the same state, i.e., both at V_{CCI} or both at GND.

Note 2: V_{CCA} must be less than or equal to V_{CCB} and must not exceed 3.6 V.

Note 3: V_{CCI} is the supply voltage associated with the input port.

Electrical Characteristics (Note 1, 2)

Over recommended operating free-air temperature range (unless otherwise noted)

Parameter	Test Conditions	V _{CCA}	V _{CCB}	T _A =25°C		-40°C to 85°C		Unit	
				Typ	Max	Min	Max		
V _{OHA}	I _{OH} =-20μA	1.2V		1.1				V	
		1.4V to 3.6V				V _{CCA} -0.4			
V _{OLA}	I _{OL} =20μA	1.2V		0.3				V	
		1.4V to 3.6V				0.4			
V _{OHB}	I _{OH} =-20μA		1.65V to 5.5V			V _{CCB} -0.4		V	
V _{OLB}	I _{OL} =20μA		1.65V to 5.5V			0.4		V	
I _I	OE	1.2V to 3.6V	1.65V to 5.5V	±1		±2		μA	
I _{off}	A Port	0V	0V to 5.5V	±1		±2		μA	
	B Port	0V to 3.6V	0V	±1		±2			
I _{OZ}	A or B Port	OE=GND	1.2V to 3.6V	1.65V to 5.5V	±1		±2		μA
I _{CCA}	V _I =V _{CCI} or GND I _O =0	1.2V	1.65V to 5.5V	0.06				μA	
		1.4V to 3.6V	1.65V to 5.5V			5			
		3.6V	0V			2			
		0V	5.5V			-2			
I _{CCB}	V _I =V _{CCI} or GND I _O =0	1.2V	1.65V to 5.5V	3.5				μA	
		1.4V to 3.6V	1.65V to 5.5V			5			
		3.6V	0V			-2			
		0V	5.5V			2			
I _{CCA} +I _{CCB}	V _I =V _{CCI} or GND I _O =0	1.2V	1.65V to 5.5V	3.5				μA	
		1.4V to 3.6V	1.65V to 5.5V			10			
I _{CCZA}	V _I =V _{CCI} or GND I _O =0, OE=GND	1.2V	1.65V to 5.5V	0.05				μA	
		1.4V to 3.6V	1.65V to 5.5V			5			
I _{CCZB}	V _I =V _{CCI} or GND I _O =0, OE=GND	1.2V	1.65V to 5.5V	3.5				μA	
		1.4V to 3.6V	1.65V to 5.5V			5			
C _i	OE	1.2V to 3.6V	1.65V to 5.5V	5		5.5		pF	
C _{io}	A Port	1.2V to 3.6V	1.65V to 5.5V	5		6.5		pF	
	B Port			8		10			

 Note 1: V_{CCI} is the supply voltage associated with the input port.

 Note 2: V_{CCO} is the supply voltage associated with the output port.

Switching Characteristics
 $T_A=+25^{\circ}\text{C}$, $V_{CCA}=1.2\text{V}$

Parameter	From (Input)	To (Output)	$V_{CCB}=1.8\text{V}$	$V_{CCB}=2.5\text{V}$	$V_{CCB}=3.3\text{V}$	$V_{CCB}=5\text{V}$	Unit
			Typ	Typ	Typ	Typ	
t_{pd}	A	B	7	6	5.3	5.5	ns
	B	A	7.5	6.5	6	6	
t_{en}	OE	A	1	1	1	1	μs
		B	1	1	1	1	
t_{dis}	OE	A	18	16	14	14	ns
		B	19	17	15	15	
t_{rA}, t_{fA}	A Port Rise and Fall Time		5	5	5	5	ns
t_{rB}, t_{fB}	B Port Rise and Fall Time		2.5	1.5	1.2	1	ns
$t_{SK(O)}$	Channel-to-Channel		0.5	0.5	0.5	1.5	ns
Max Data Rate			20	20	20	20	Mbps

Switching Characteristics

 Over recommended operating free-air temperature range, $V_{CCA}=1.5\text{V}\pm 0.1\text{V}$ (unless otherwise noted)

Parameter	From (Input)	To (Output)	$V_{CCB}=1.8\text{V}\pm 0.15\text{V}$		$V_{CCB}=2.5\text{V}\pm 0.2\text{V}$		$V_{CCB}=3.3\text{V}\pm 0.3\text{V}$		$V_{CCB}=5\text{V}\pm 0.5\text{V}$		Unit
			Min	Max	Min	Max	Min	Max	Min	Max	
t_{pd}	A	B	2	15	1.2	11	1.1	10	1	10	ns
	B	A	1	15	0.9	12	0.5	12	0.3	13	
t_{en}	OE	A		1		1		1		1	μs
		B		1		1		1		1	
t_{dis}	OE	A	6	30	5.5	28	5.5	25	5.5	23	ns
		B	5.5	30	5	25	5	20	5	20	
t_{rA}, t_{fA}	A Port Rise and Fall Time		1.5	5.0	1.5	5.0	1.5	5.0	1.5	5.0	ns
t_{rB}, t_{fB}	B Port Rise and Fall Time		0.9	4.5	0.6	3.5	0.5	3	0.4	2.5	ns
$t_{SK(O)}$	Channel-to-Channel			0.5		0.5		0.5		0.5	ns
Max Data Rate			40		40		40		40		Mbps

Switching Characteristics

Over recommended operating free-air temperature range, $V_{CCA}=1.8V\pm 0.15V$ (unless otherwise noted)

Parameter	From (Input)	To (Output)	$V_{CCB}=1.8V \pm 0.15V$		$V_{CCB}=2.5V \pm 0.2V$		$V_{CCB}=3.3V \pm 0.3V$		$V_{CCB}=5V \pm 0.5V$		Unit
			Min	Max	Min	Max	Min	Max	Min	Max	
t_{pd}	A	B	1.6	10	1.4	9	1.3	7	1.2	6.5	ns
	B	A	1.5	12	1.3	8.5	1	8	0.9	8	
t_{en}	OE	A		1		1		1		1	μs
		B		1		1		1		1	
t_{dis}	OE	A	6	34	5.5	23	5	20	5	17.6	ns
		B	5.5	33	4.5	22	4.2	16.8	4.4	16.3	
t_{rA}, t_{fA}	A Port Rise and Fall Time		1	4.2	1.1	4.0	1.1	4.0	1.1	4.0	ns
t_{rB}, t_{fB}	B Port Rise and Fall Time		0.9	4	0.6	3.2	0.5	2.8	0.4	2.8	ns
$t_{SK(O)}$	Channel-to-Channel			0.5		0.5		0.5		0.5	ns
Max Data Rate			60		60		60		60		Mbps

Switching Characteristics

Over recommended operating free-air temperature range, $V_{CCA}=2.5V\pm 0.2V$ (unless otherwise noted)

Parameter	From (Input)	To (Output)	$V_{CCB}=2.5V \pm 0.2V$		$V_{CCB}=3.3V \pm 0.3V$		$V_{CCB}=5V \pm 0.5V$		Unit
			Min	Max	Min	Max	Min	Max	
t_{pd}	A	B	1.1	6.5	1	5.2	0.9	5	ns
	B	A	1.2	6.6	1.1	5.1	0.9	4.4	
t_{en}	OE	A		1		1		1	μs
		B		1		1		1	
t_{dis}	OE	A	5.0	23	4.6	15.2	4.6	13	ns
		B	4.4	22	3.8	16	3.9	13.3	
t_{rA}, t_{fA}	A Port Rise and Fall Time		0.8	3	0.8	3	0.8	3	ns
t_{rB}, t_{fB}	B Port Rise and Fall Time		0.7	2.7	0.5	2.8	0.4	2.7	ns
$t_{SK(O)}$	Channel-to-Channel			0.5		0.5		0.5	ns
Max Data Rate			100		100		100		Mbps

Switching Characteristics

Over recommended operating free-air temperature range, $V_{CCA}=3.3V\pm 0.3V$ (unless otherwise noted)

Parameter	From (Input)	To (Output)	$V_{CCB}=3.3V \pm 0.3V$		$V_{CCB}=5V \pm 0.5V$		Unit
			Min	Max	Min	Max	
t_{pd}	A	B	0.9	5	0.8	4	ns
	B	A	1	5.1	0.9	4	
t_{en}	OE	A		1		1	μs
		B		1		1	
t_{dis}	OE	A	5	15	4	13	ns
		B	4	16	3.4	13.8	
t_{rA}, t_{fA}	A Port Rise and Fall Time		0.7	2.5	0.7	2.5	ns
t_{rB}, t_{fB}	B Port Rise and Fall Time		0.5	2.1	0.4	2.8	ns
$t_{SK(O)}$	Channel-to-Channel			0.5		0.5	ns
Max Data Rate			100		100		Mbps

Applications Information

UM3308/UM3308H/UM3308UK/UM3308QA/UM3308QB ESD protected level translator provides level shifting necessary to allow data transfer in a multi-voltage system. Externally applied voltages, V_{CCA} and V_{CCB} set the logic levels on either side of device. A high voltage signal present on V_{CCA} side of the device appears as a high voltage logic signal on the V_{CCB} side of the device, and vice-versa.

Block Diagram

The UM3308/UM3308H/UM3308UK/UM3308QA/UM3308QB (block diagram see Figure 1) does not require a direction-control signal to control the direction of data flow from A to B or from B to A. In a dc state, the output drivers of the UM3308/UM3308H/UM3308UK/UM3308QA/UM3308QB can maintain a high or low, but are designed to be weak, so that they can be overdriven by an external driver when data on the bus starts flowing to the opposite direction.

The output one shot detects rising or falling edges on the A or B ports. During a rising edge, the one shot turns on the PMOS transistors (T1, T3) for a short duration, which speeds up the low-to-high transition. Similarly, during a falling edge, the one shot turns on the NMOS transistors (T2, T4) for a short duration, which speeds up the high-to-low transition.

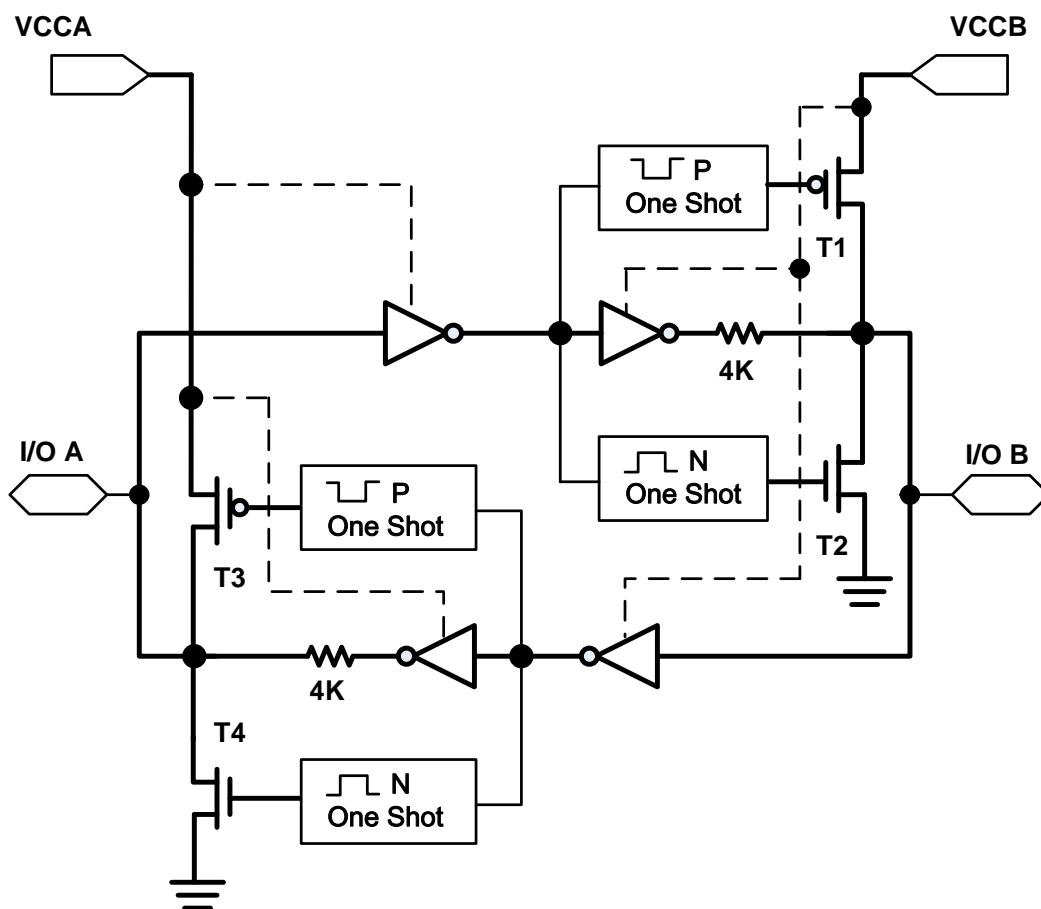
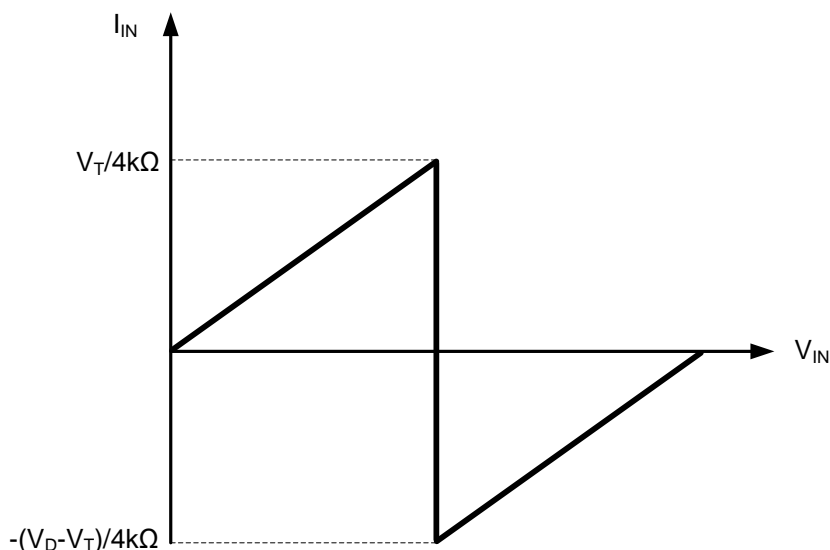

Figure 1 Block Diagram of UM3308/UM3308H/UM3308UK/UM3308QA/UM3308QB I/O Cell

Input Driver Requirements

Typical I_{IN} vs V_{IN} characteristics of the UM3308/UM3308H/UM3308UK/UM3308QA/UM3308QB are shown in Figure 2. For proper operation, the device driving the data I/Os of the UM3308/UM3308H/UM3308UK/UM3308QA/UM3308QB must have driven strength of at least $\pm 2\text{mA}$.



- A: V_T is the input threshold voltage of the UM3308/UM3308H/UM3308UK/UM3308QA/UM3308QB (typical $V_{CC1}/2$).
 B: V_D is the supply voltage of the external driver.

Figure 2 Typical I_{IN} vs. V_{IN} Curve

Power Up

During operation, ensure that $V_{CCA} \leq V_{CCB}$ at all times. During power-up sequencing, $V_{CCA} \geq V_{CCB}$ does not damage the device, so any power supply can be ramped up first. The UM3308/UM3308H/UM3308UK/UM3308QA/UM3308QB has circuitry that disables all output ports when either V_{CC} is switched off ($V_{CCA/B} = 0\text{ V}$).

Enable and Disable

The UM3308/UM3308H/UM3308UK/UM3308QA/UM3308QB has an OE input that is used to disable the device by setting OE=low, which places all I/Os in the high-impedance (Hi-Z) state. The disable time (t_{dis}) indicates the delay between when OE goes low and when the outputs actually get disabled (Hi-Z). The enable time (t_{en}) indicates the amount of time the user must allow for the one-shot circuitry to become operational after OE is taken high.

Pull-up or Pull-down Resistors on I/O Lines

The UM3308/UM3308H/UM3308UK/UM3308QA/UM3308QB is designed to drive capacitive loads of up to 50pF. The output drivers of the UM3308/UM3308H/UM3308UK/UM3308QA/UM3308QB have low dc drive strength. If pull-up or pull-down resistors are connected externally to the data I/Os, their values must be kept higher than 50k Ω to ensure that they do not contend with the output drivers of the UM3308/UM3308H/UM3308UK/UM3308QA/UM3308QB.

For the same reason, the UM3308/UM3308H/UM3308UK/UM3308QA/UM3308QB should not be used in applications such as I²C or 1-Wire where an open-drain driver is connected on the bidirectional data I/O.

Typical Operating Circuit

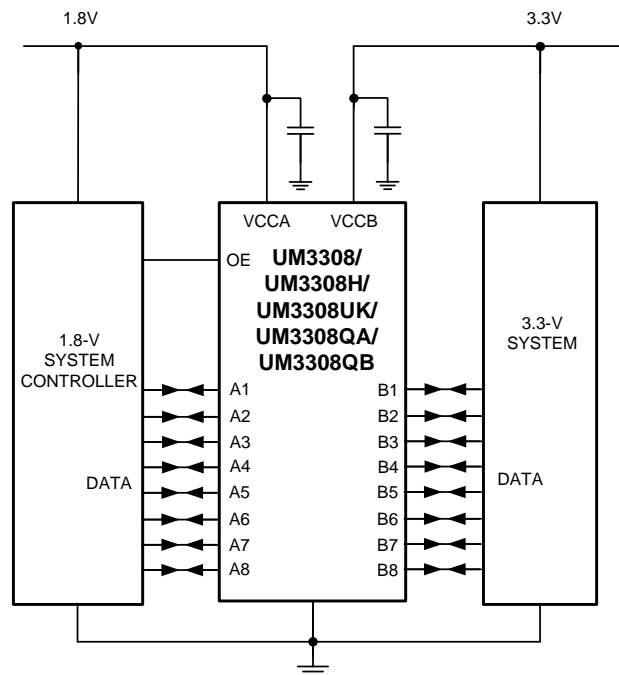
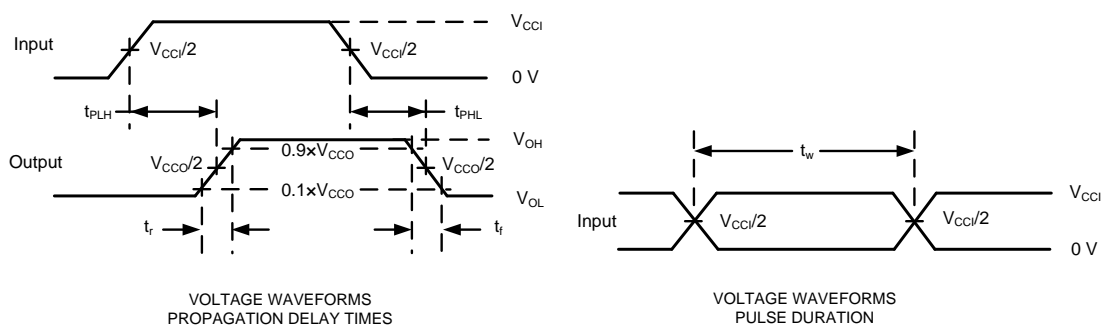
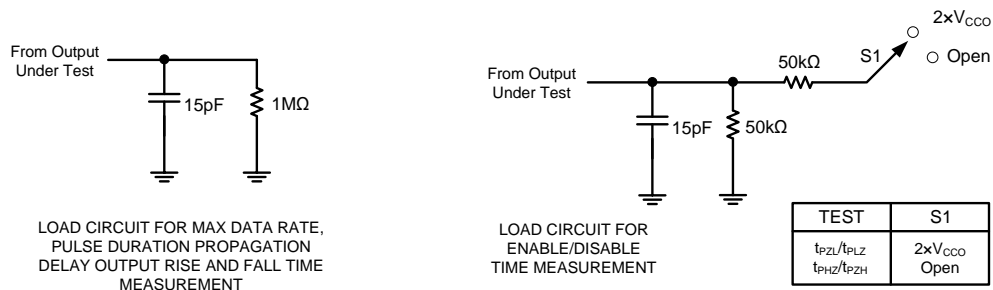

Figure 3 Typical Operating Circuit

Test Circuits



- A. C_L includes probe and jig capacitance.
- B. All input pulses are supplied by generators having the following characteristics: $PRR \leq 10\text{MHz}$, $Z_o = 50\Omega$, $dv/dt \geq 1\text{V/ns}$.
- C. The outputs are measured one at a time, with one transition per measurement.
- D. t_{PLH} and t_{PHL} are the same as t_{pd} .
- E. V_{CCI} is the V_{CC} associated with the input port.
- F. V_{CCO} is the V_{CC} associated with the output port.
- G. All parameters and waveforms are not applicable to all devices.

Figure 4 Load Circuits and Voltage Waveforms

Package Information

UM3308/ UM3308H: CSP20 2.4×1.9

Outline Drawing

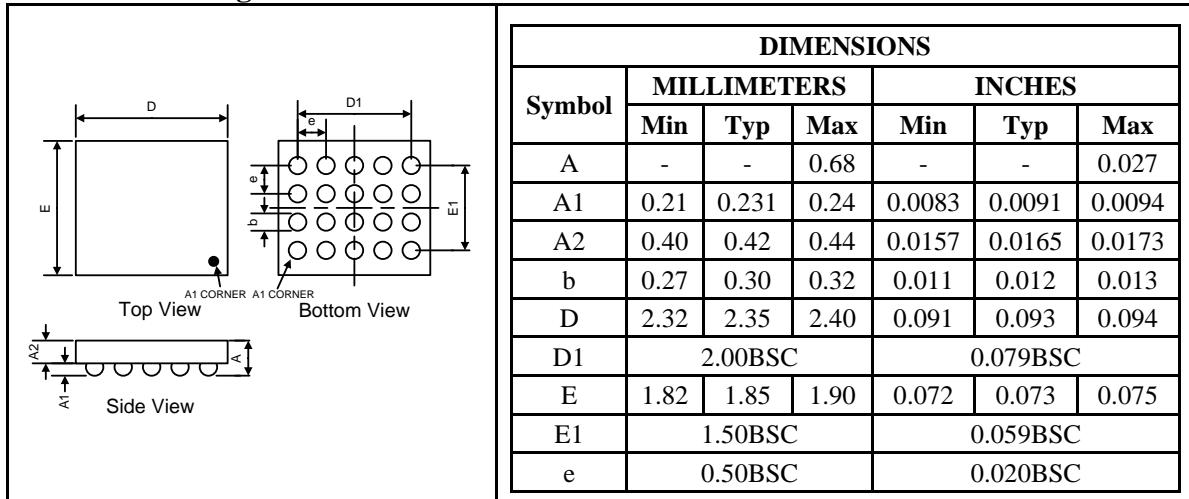

Land Pattern

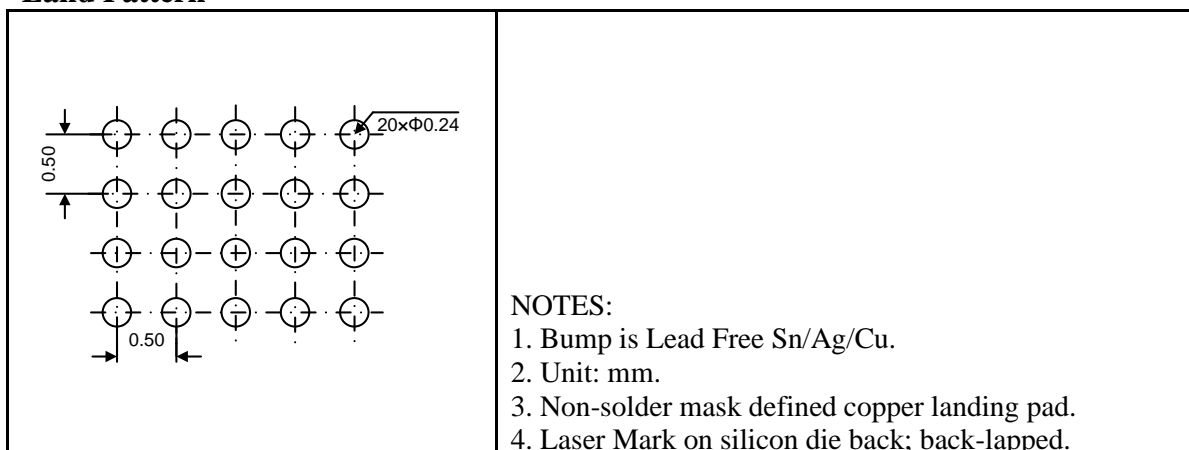

Tape and Reel Orientation



UM3308UK TSSOP20

Outline Drawing

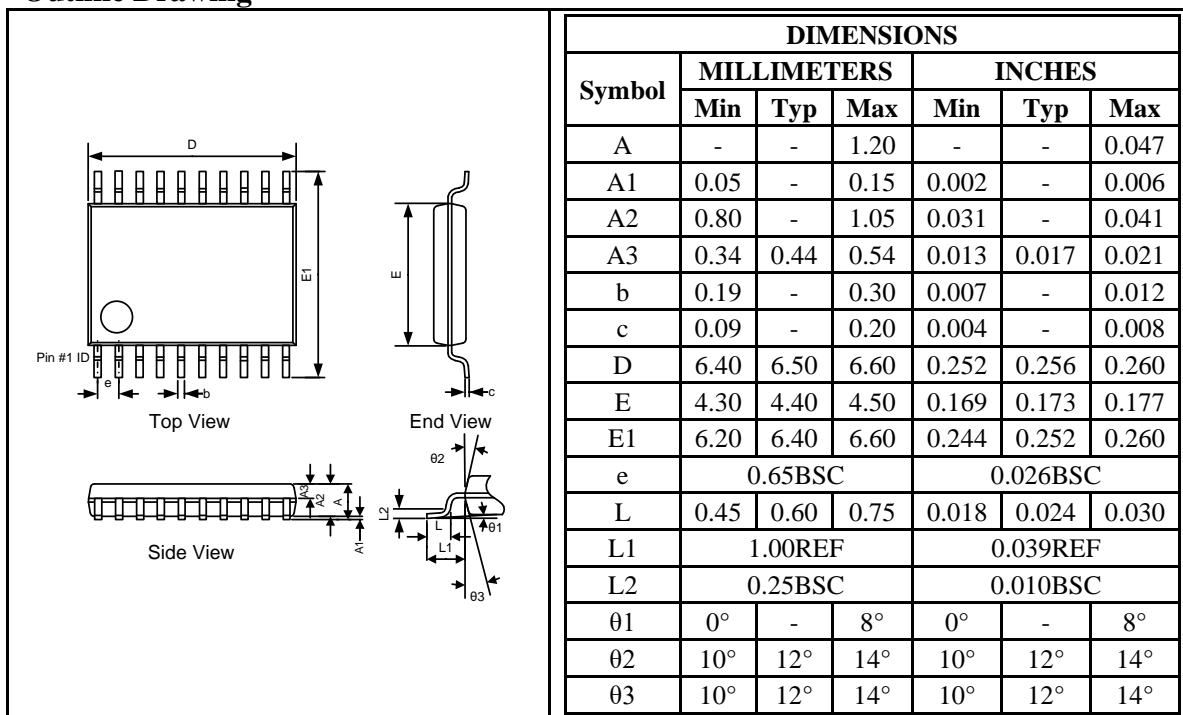

Land Pattern

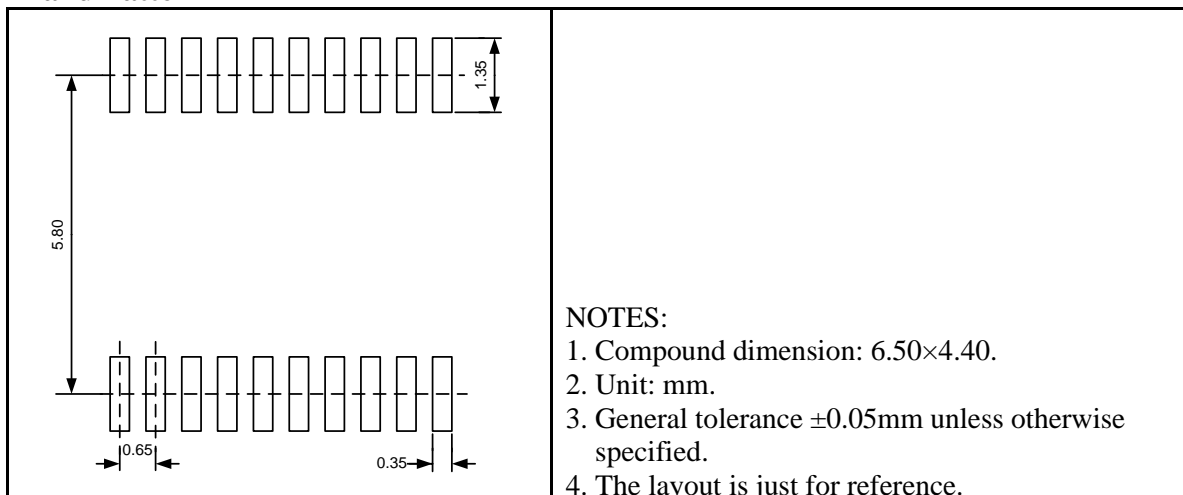

Tape and Reel Orientation

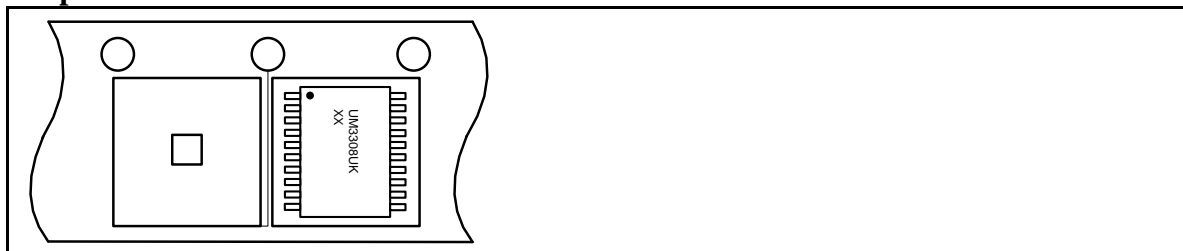

UM3308QA QFN20 4.5×3.5

Outline Drawing

DIMENSIONS						
Symbol	MILLIMETERS			INCHES		
	Min	Typ	Max	Min	Typ	Max
A	0.70	0.75	0.80	0.028	0.030	0.032
A1	-	0.01	0.05	-	0.0004	0.002
A3	0.18	0.20	0.25	0.007	0.008	0.010
b	0.18	0.25	0.30	0.007	0.010	0.012
D	4.40	4.50	4.60	0.176	0.180	0.184
D2	3.10	3.20	3.30	0.124	0.128	0.132
D3	3.85REF			0.154REF		
E	3.40	3.50	3.60	0.136	0.140	0.144
E2	2.10	2.20	2.30	0.084	0.088	0.092
E3	0.35REF			0.014REF		
E4	0.75REF			0.030REF		
e	0.50BSC			0.020BSC		
e1	0.75BSC			0.030BSC		
L	0.35	0.40	0.45	0.014	0.016	0.018

Land Pattern

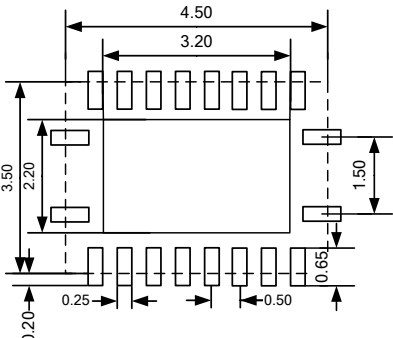
	<p>NOTES:</p> <ol style="list-style-type: none"> 1. Compound dimension: 4.50×3.50; 2. Unit: mm; 3. General tolerance $\pm 0.05\text{mm}$ unless otherwise specified; 4. The layout is just for reference.
---	--

Tape and Reel Orientation

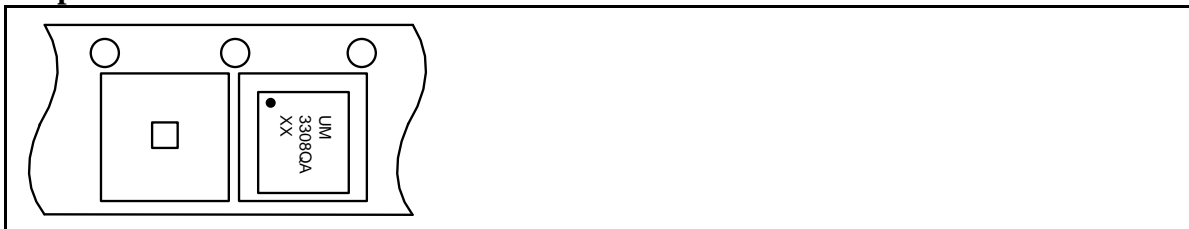

UM3308QB QFN20 3.0×3.0

Outline Drawing

DIMENSIONS						
Symbol	MILLIMETERS			INCHES		
	Min	Typ	Max	Min	Typ	Max
A	0.70	0.75	0.80	0.028	0.030	0.031
A1	0	0.02	0.05	0	0.001	0.002
A3	0.20REF			0.008REF		
b	0.15	0.20	0.25	0.006	0.008	0.010
D	2.90	3.00	3.10	0.114	0.118	0.122
E	2.90	3.00	3.10	0.114	0.118	0.122
D2	1.40	1.50	1.60	0.055	0.059	0.063
E2	1.40	1.50	1.60	0.055	0.059	0.063
e	0.30	0.40	0.50	0.012	0.016	0.020
H	0.35REF			0.014REF		
K	0.35REF			0.014REF		
L	0.35	0.40	0.45	0.014	0.016	0.018

Land Pattern

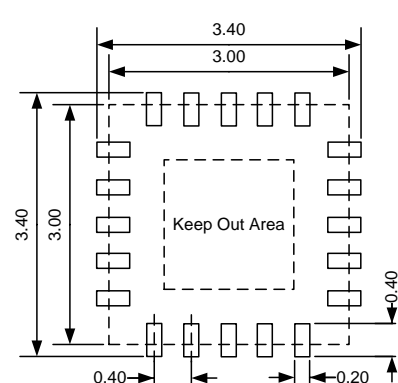
	<p>NOTES:</p> <ol style="list-style-type: none"> 1. Compound dimension: 3.0×3.0; 2. Unit: mm; 3. General tolerance $\pm 0.05\text{mm}$ unless otherwise specified; 4. The layout is just for reference.
---	--

Tape and Reel Orientation



GREEN COMPLIANCE

Union Semiconductor is committed to environmental excellence in all aspects of its operations including meeting or exceeding regulatory requirements with respect to the use of hazardous substances. Numerous successful programs have been implemented to reduce the use of hazardous substances and/or emissions.

All Union components are compliant with the RoHS directive, which helps to support customers in their compliance with environmental directives. For more green compliance information, please visit:

http://www.union-ic.com/index.aspx?cat_code=RoHSDeclaration

IMPORTANT NOTICE

The information in this document has been carefully reviewed and is believed to be accurate. Nonetheless, this document is subject to change without notice. Union assumes no responsibility for any inaccuracies that may be contained in this document, and makes no commitment to update or to keep current the contained information, or to notify a person or organization of any update. Union reserves the right to make changes, at any time, in order to improve reliability, function or design and to attempt to supply the best product possible.



Union Semiconductor, Inc

Add: Unit 606, No.570 Shengxia Road, Shanghai 201210

Tel: 021-51093966

Fax: 021-51026018

Website: www.union-ic.com