

C3M0075120K

Silicon Carbide Power MOSFET

C3M™ MOSFET Technology

N-Channel Enhancement Mode

Features

- 3rd generation SiC MOSFET technology
- Optimized package with separate driver source pin
- 8mm of creepage distance between drain and source
- High blocking voltage with low on-resistance
- High-speed switching with low capacitances
- Fast intrinsic diode with low reverse recovery (Q_{rr})
- Halogen free, RoHS compliant

Benefits

- Reduce switching losses and minimize gate ringing
- Higher system efficiency
- Reduce cooling requirements
- Increase power density
- Increase system switching frequency

Applications

- Renewable energy
- EV battery chargers
- High voltage DC/DC converters
- Switch Mode Power Supplies

V_{DS}	1200 V
$I_D @ 25^\circ\text{C}$	32 A
$R_{DS(on)}$	75 m Ω

Package

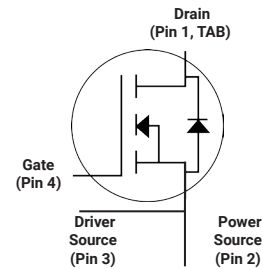

Ordering Part Number	Package	Marking	T_J, T_{stg} Range
C3M0075120K	TO 247-4	C3M0075120K	-55 - 150 °C
C3M0075120K-A	TO 247-4	C3M0075120K-A	-40 - 175 °C

Maximum Ratings ($T_C = 25^\circ\text{C}$ unless otherwise specified)

Symbol	Parameter	Value	Unit	Test Conditions	Note
V_{DSmax}	Drain - Source Voltage	1200	V	$V_{GS} = 0\text{ V}, I_D = 100\ \mu\text{A}$	
V_{GSmax}	Gate - Source Voltage (dynamic)	-8/+19	V	AC ($f > 1\text{ Hz}$)	Note: 1
V_{GSop}	Gate - Source Voltage (static)	-4/+15	V	Static	Note: 2
I_D	Continuous Drain Current	32	A	$V_{GS} = 15\text{ V}, T_C = 25^\circ\text{C}$	Fig. 19
		23		$V_{GS} = 15\text{ V}, T_C = 100^\circ\text{C}$	
$I_{D(pulse)}$	Pulsed Drain Current	80	A	Pulse width t_p limited by T_{jmax}	Fig. 22
P_D	Power Dissipation	136	W	$T_C = 25^\circ\text{C}, T_J = 175^\circ\text{C}$	Fig. 20
T_J, T_{stg}	Operating Junction and Storage Temperature	-40 to +175	°C		
T_L	Solder Temperature	260	°C	1.6mm (0.063") from case for 10s	

Note (1): When using MOSFET Body Diode $V_{GSmax} = -4\text{V}/+19\text{V}$

Note (2): MOSFET can also safely operate at $0/+15\text{ V}$



Electrical Characteristics ($T_c = 25^\circ\text{C}$ unless otherwise specified)

Symbol	Parameter	Min.	Typ.	Max.	Unit	Test Conditions	Note
$V_{(BR)DSS}$	Drain-Source Breakdown Voltage	1200			V	$V_{GS} = 0\text{ V}, I_D = 100\ \mu\text{A}$	
$V_{GS(th)}$	Gate Threshold Voltage	1.8	2.5	3.6	V	$V_{DS} = V_{GS}, I_D = 5\text{ mA}$	Fig. 11
			2.2		V	$V_{DS} = V_{GS}, I_D = 5\text{ mA}, T_J = 175^\circ\text{C}$	
I_{DSS}	Zero Gate Voltage Drain Current		1	50	μA	$V_{DS} = 1200\text{ V}, V_{GS} = 0\text{ V}$	
I_{GSS}	Gate-Source Leakage Current		10	250	nA	$V_{GS} = 15\text{ V}, V_{DS} = 0\text{ V}$	
$R_{DS(on)}$	Drain-Source On-State Resistance		75	90	m Ω	$V_{GS} = 15\text{ V}, I_D = 20\text{ A}$	Fig. 4, 5, 6
			120			$V_{GS} = 15\text{ V}, I_D = 20\text{ A}, T_J = 175^\circ\text{C}$	
g_{fs}	Transconductance		12		S	$V_{DS} = 20\text{ V}, I_{DS} = 20\text{ A}$	Fig. 7
			13			$V_{DS} = 20\text{ V}, I_{DS} = 20\text{ A}, T_J = 175^\circ\text{C}$	
C_{iss}	Input Capacitance		1390		pF	$V_{GS} = 0\text{ V}, V_{DS} = 1000\text{ V}$ $f = 1\text{ MHz}$ $V_{AC} = 25\text{ mV}$	Fig. 17, 18
C_{oss}	Output Capacitance		58				
C_{rss}	Reverse Transfer Capacitance		2				
E_{oss}	C_{oss} Stored Energy		33		μJ		Fig. 16
E_{ON}	Turn-On Switching Energy (Body Diode FWD)		270		μJ	$V_{DS} = 800\text{ V}, V_{GS} = -4\text{ V}/15\text{ V}, I_D = 20\text{ A},$ $R_{G(ext)} = 0\ \Omega, L = 156\ \mu\text{H}, T_J = 150^\circ\text{C}$	Fig. 26, 29
E_{OFF}	Turn-Off Switching Energy (Body Diode FWD)		77				
$t_{d(on)}$	Turn-On Delay Time		30		ns	$V_{DD} = 800\text{ V}, V_{GS} = -4\text{ V}/15\text{ V}$ $I_D = 20\text{ A}, R_{G(ext)} = 0\ \Omega,$ Timing relative to V_{DS} Inductive load	Fig. 27, 28
t_r	Rise Time		14				
$t_{d(off)}$	Turn-Off Delay Time		38				
t_f	Fall Time		10				
$R_{G(int)}$	Internal Gate Resistance		9.0		Ω	$f = 1\text{ MHz}, V_{AC} = 25\text{ mV}$	
Q_{gs}	Gate to Source Charge		17		nC	$V_{DS} = 800\text{ V}, V_{GS} = -4\text{ V}/15\text{ V}$ $I_D = 20\text{ A}$ Per IEC60747-8-4 pg 21	Fig. 12
Q_{gd}	Gate to Drain Charge		18				
Q_g	Total Gate Charge		53				

Reverse Diode Characteristics ($T_c = 25^\circ\text{C}$ unless otherwise specified)

Symbol	Parameter	Typ.	Max.	Unit	Test Conditions	Note
V_{SD}	Diode Forward Voltage	4.5		V	$V_{GS} = -4\text{ V}, I_{SD} = 10\text{ A}$	Fig. 8, 9, 10
		4.0		V	$V_{GS} = -4\text{ V}, I_{SD} = 10\text{ A}, T_J = 175^\circ\text{C}$	
I_S	Continuous Diode Forward Current		26	A	$V_{GS} = -4\text{ V}, T_J = 25^\circ\text{C}$	Note 1
$I_{S,pulse}$	Diode pulse Current	80		A	$V_{GS} = -4\text{ V},$ pulse width t_p limited by T_{jmax}	Note 1
t_{rr}	Reverse Recover time	20		ns	$V_{GS} = -4\text{ V}, I_{SD} = 20\text{ A}, V_R = 800\text{ V}$ $dif/dt = 3600\text{ A}/\mu\text{s}, T_J = 150^\circ\text{C}$	Note 1
Q_{rr}	Reverse Recovery Charge	254		nC		
I_{rrm}	Peak Reverse Recovery Current	18		A		

Thermal Characteristics

Symbol	Parameter	Max.	Unit	Test Conditions	Note
$R_{\theta JC}$	Thermal Resistance from Junction to Case	1.1	$^\circ\text{C}/\text{W}$		Fig. 21
$R_{\theta JA}$	Thermal Resistance From Junction to Ambient	40			

Typical Performance

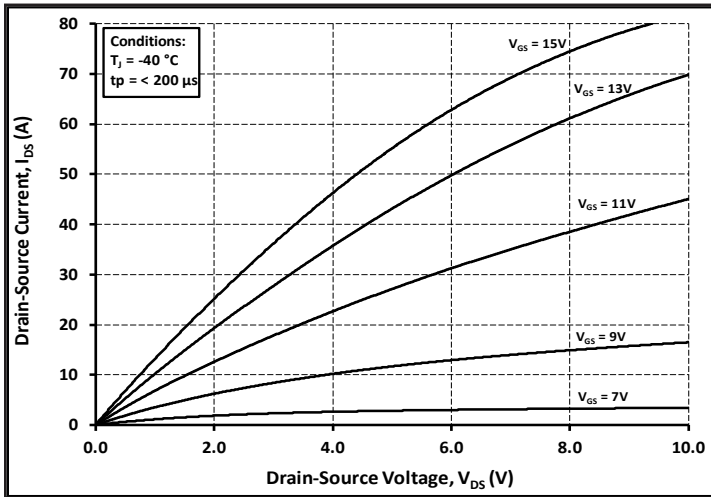

Figure 1. Output Characteristics $T_J = -40\text{ }^\circ\text{C}$

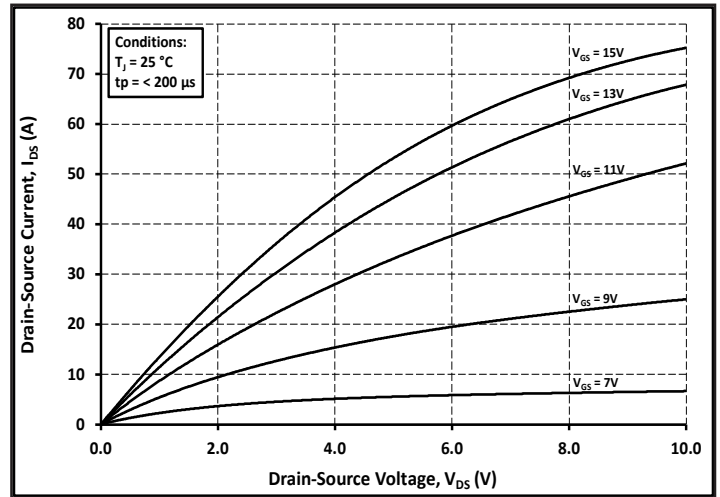

Figure 2. Output Characteristics $T_J = 25\text{ }^\circ\text{C}$

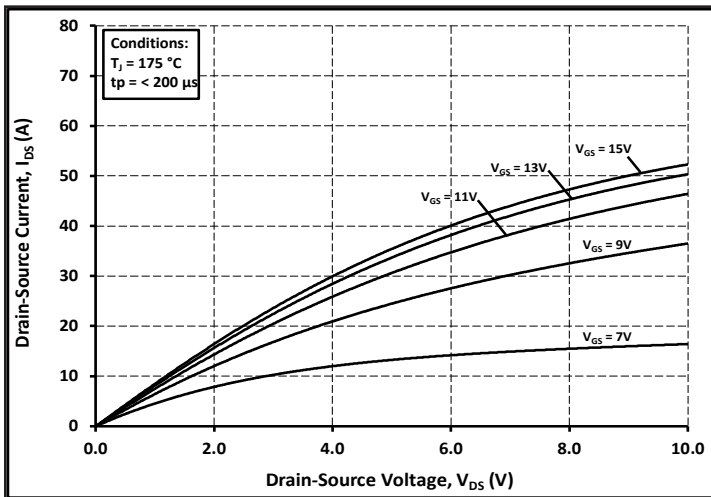

Figure 3. Output Characteristics $T_J = 175\text{ }^\circ\text{C}$

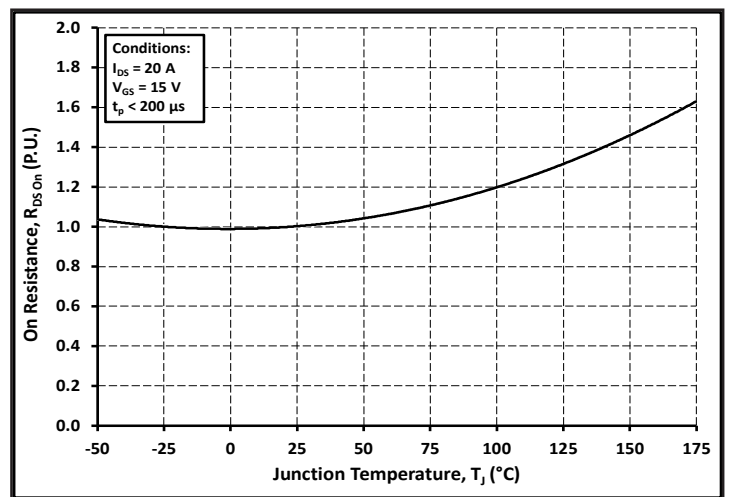

Figure 4. Normalized On-Resistance vs. Temperature

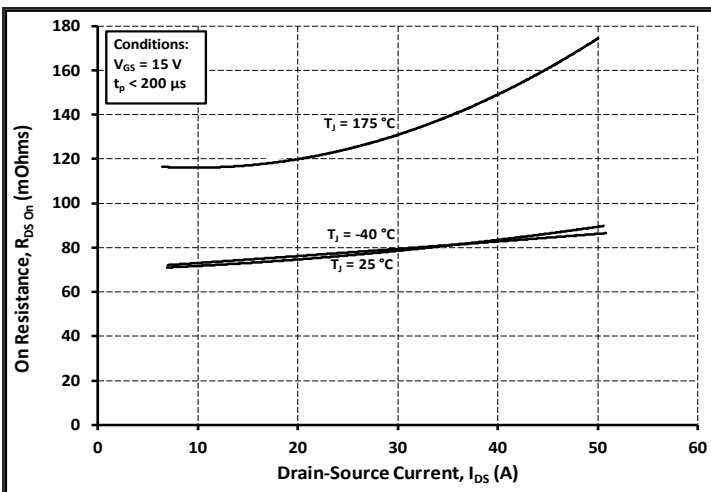

Figure 5. On-Resistance vs. Drain Current For Various Temperatures

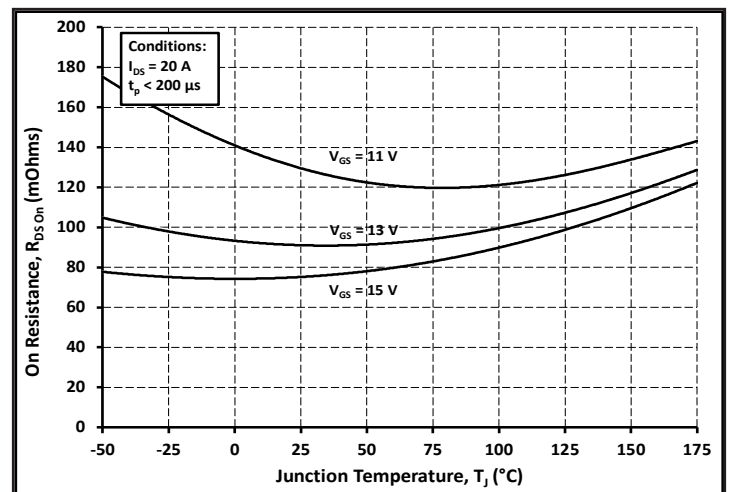

Figure 6. On-Resistance vs. Temperature For Various Gate Voltage

Typical Performance

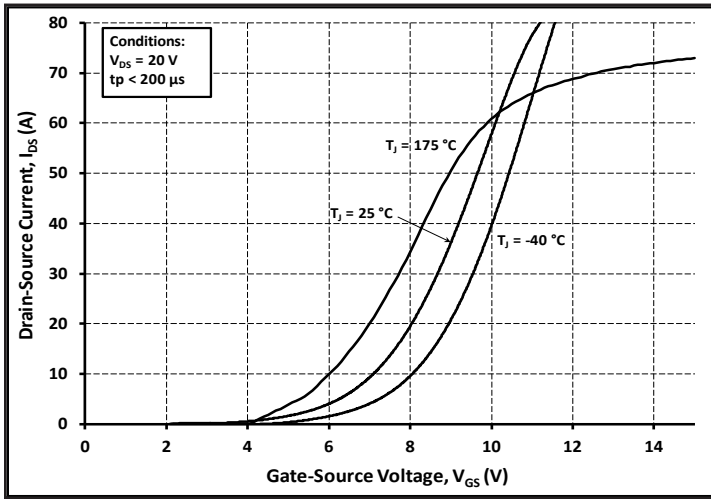

Figure 7. Transfer Characteristic for Various Junction Temperatures

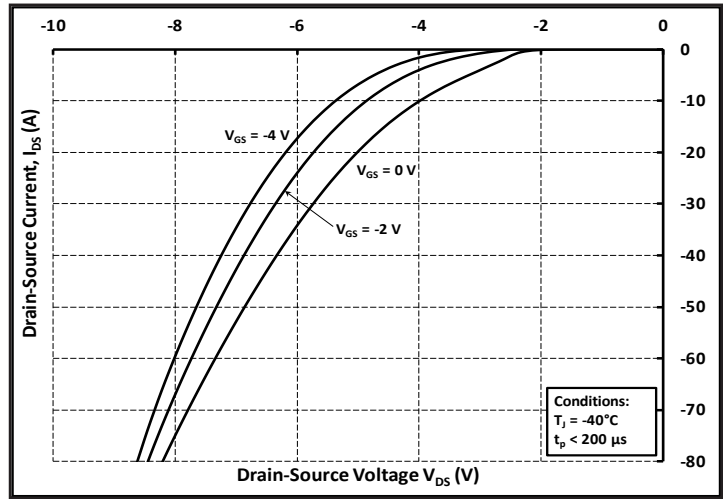

Figure 8. Body Diode Characteristic at $-40\text{ }^\circ\text{C}$

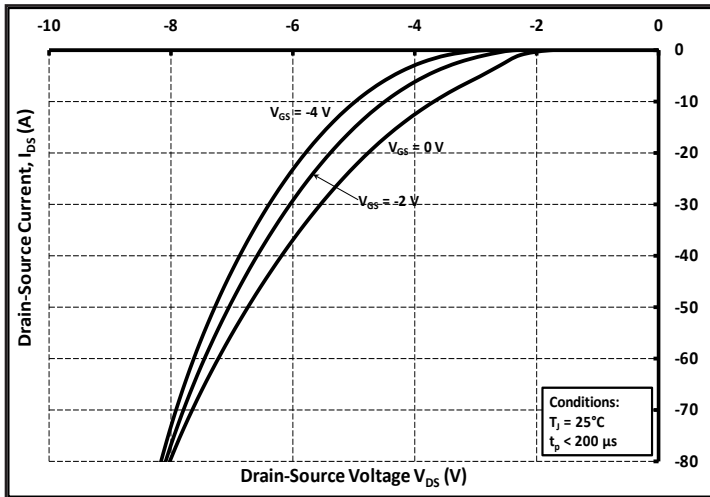

Figure 9. Body Diode Characteristic at $25\text{ }^\circ\text{C}$

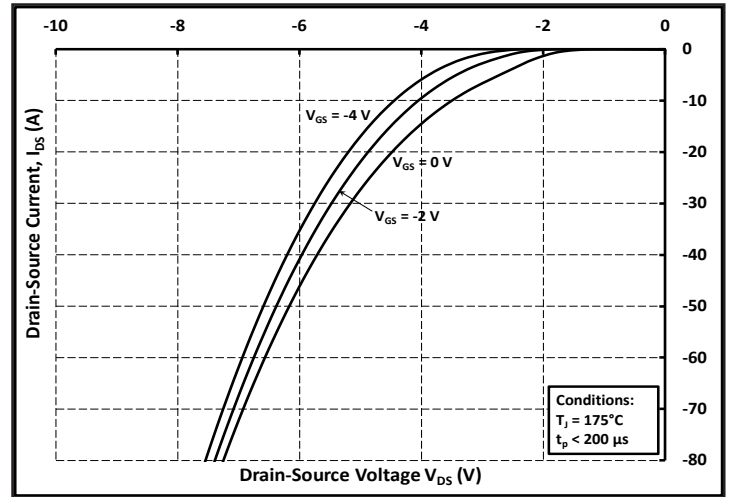

Figure 10. Body Diode Characteristic at $175\text{ }^\circ\text{C}$

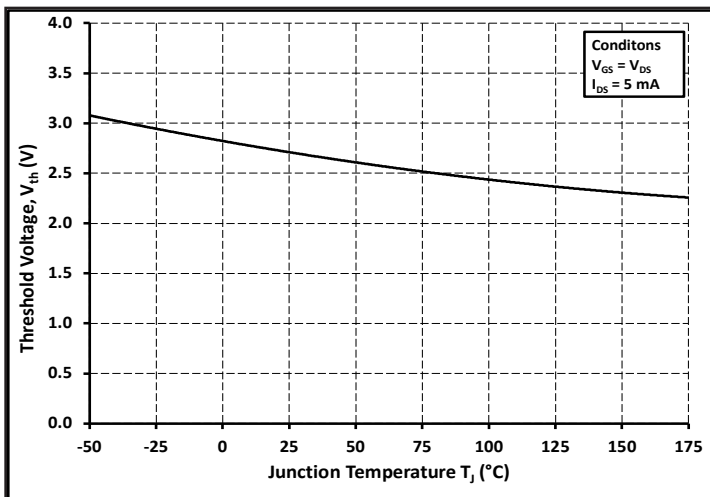

Figure 11. Threshold Voltage vs. Temperature

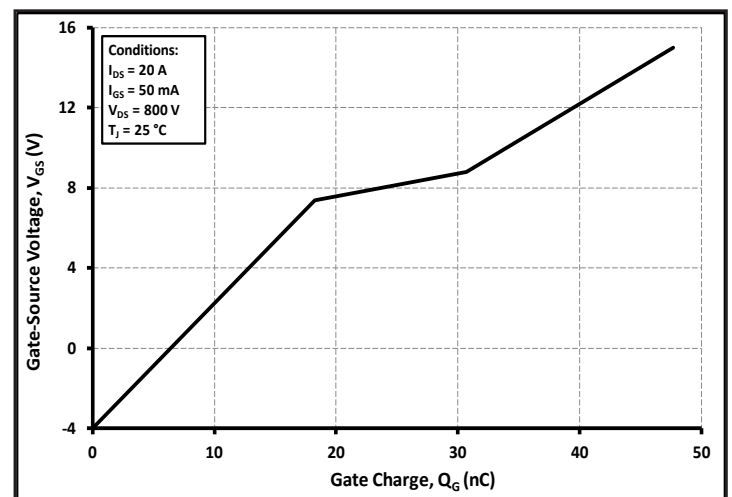

Figure 12. Gate Charge Characteristics

Typical Performance

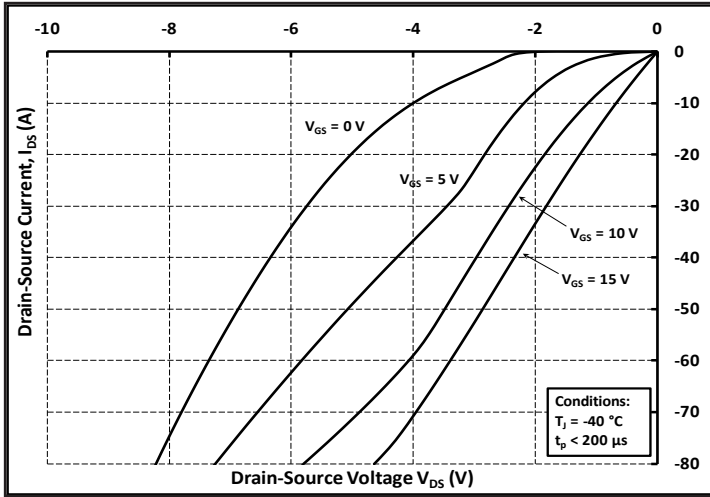

Figure 13. 3rd Quadrant Characteristic at -40 °C

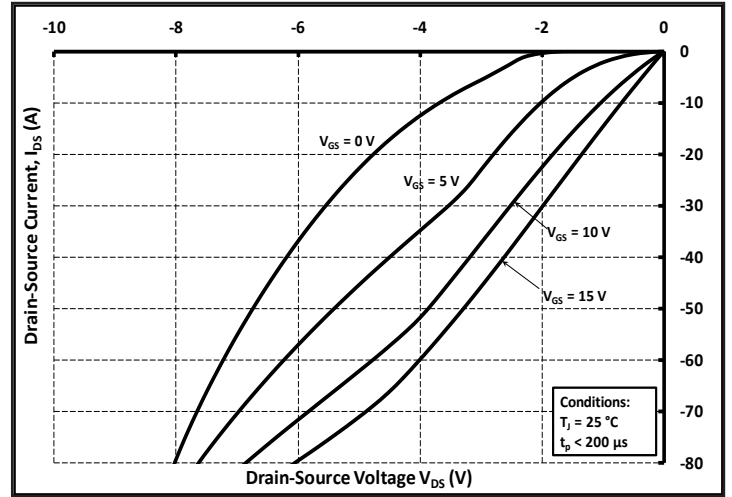

Figure 14. 3rd Quadrant Characteristic at 25 °C

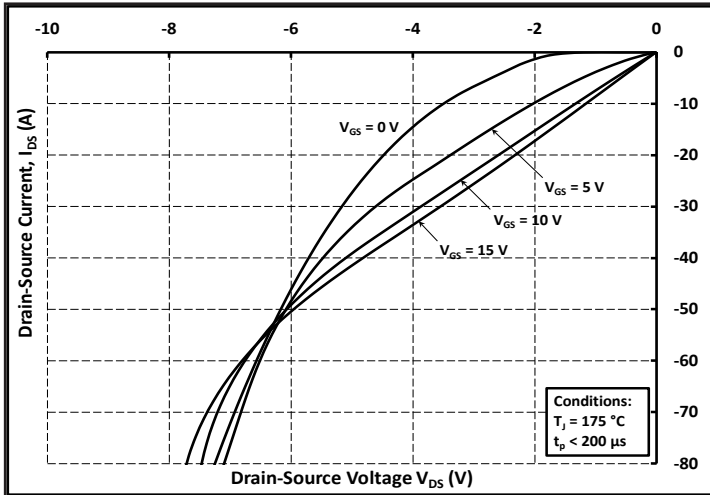

Figure 15. 3rd Quadrant Characteristic at 175 °C

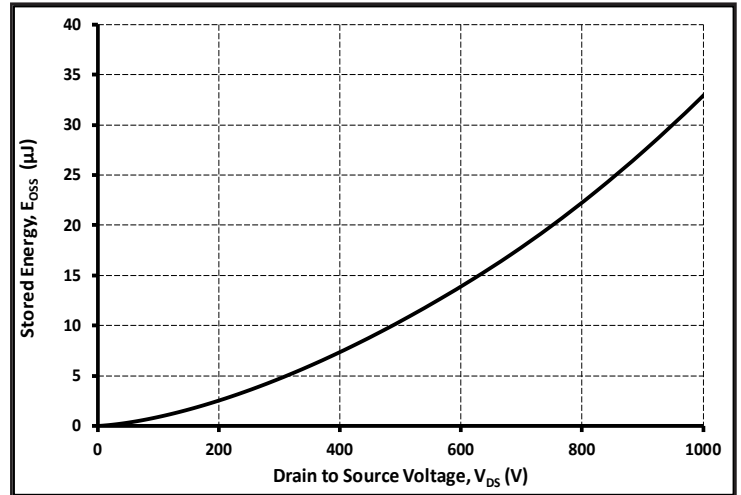

Figure 16. Output Capacitor Stored Energy

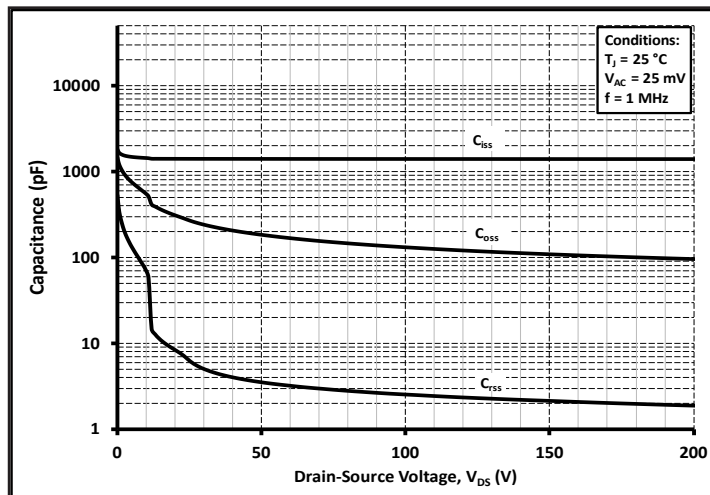

Figure 17. Capacitances vs. Drain-Source Voltage (0 - 200V)

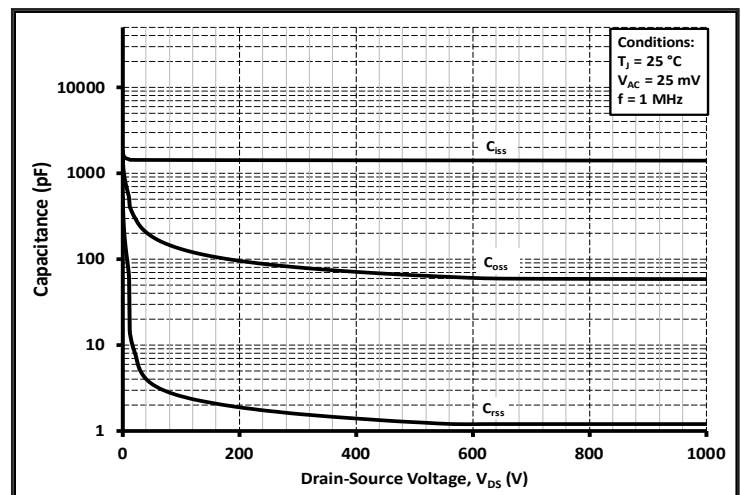

Figure 18. Capacitances vs. Drain-Source Voltage (0 - 1000V)

Typical Performance

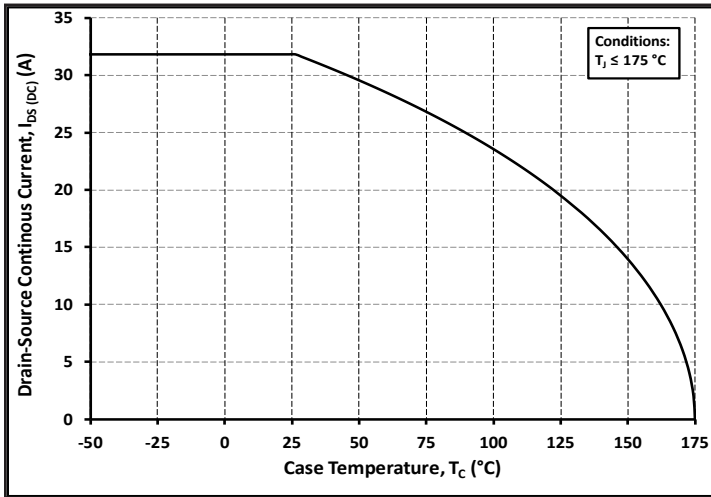

Figure 19. Continuous Drain Current Derating vs. Case Temperature

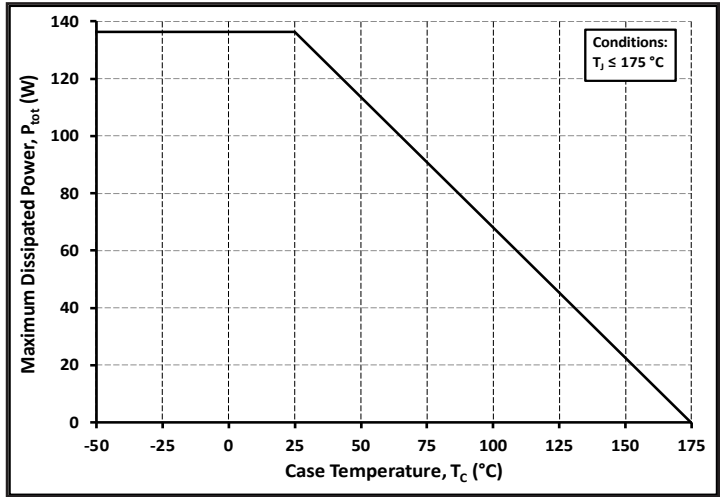

Figure 20. Maximum Power Dissipation Derating vs. Case Temperature

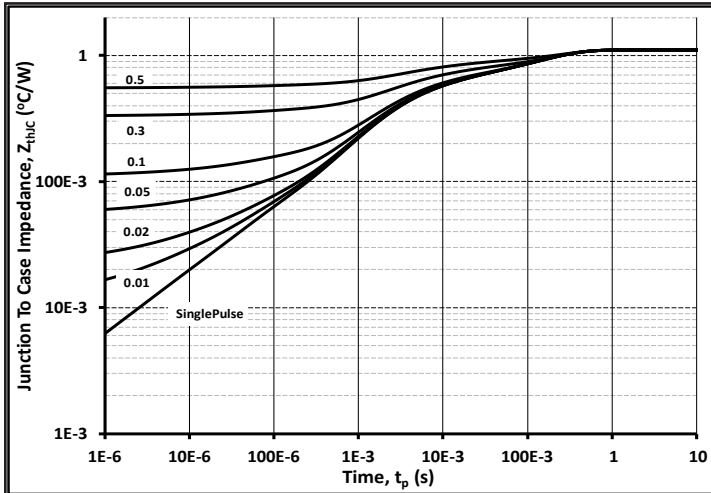

Figure 21. Transient Thermal Impedance (Junction - Case)

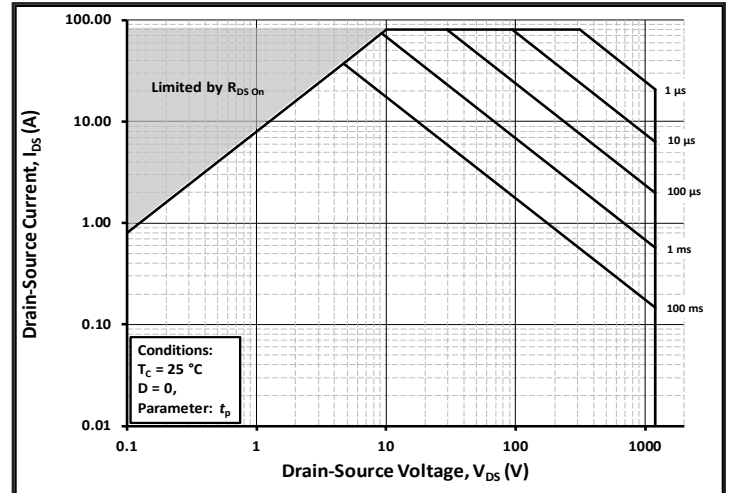

Figure 22. Safe Operating Area

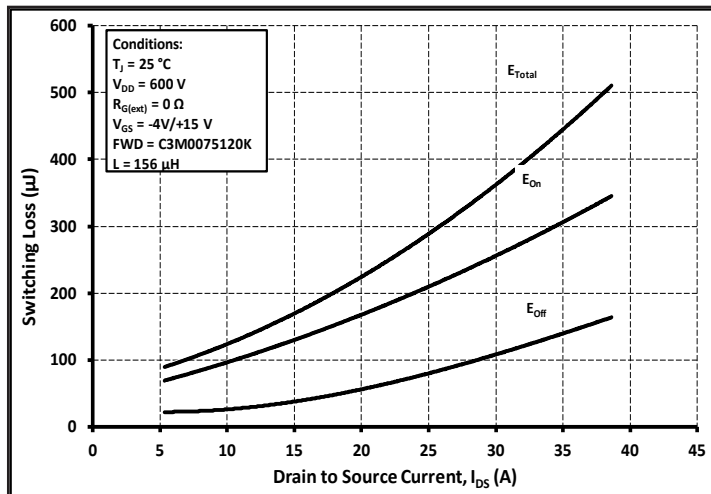

Figure 23. Clamped Inductive Switching Energy vs. Drain Current ($V_{DD} = 600V$)

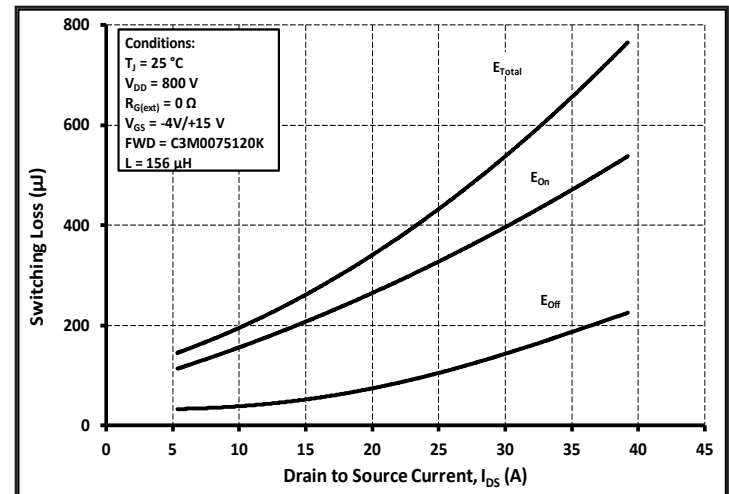

Figure 24. Clamped Inductive Switching Energy vs. Drain Current ($V_{DD} = 800V$)

Typical Performance

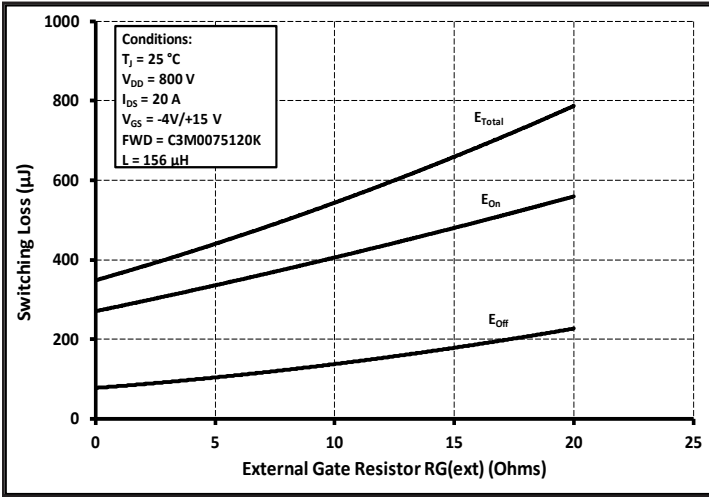

Figure 25. Clamped Inductive Switching Energy vs. $R_{G(\text{ext})}$

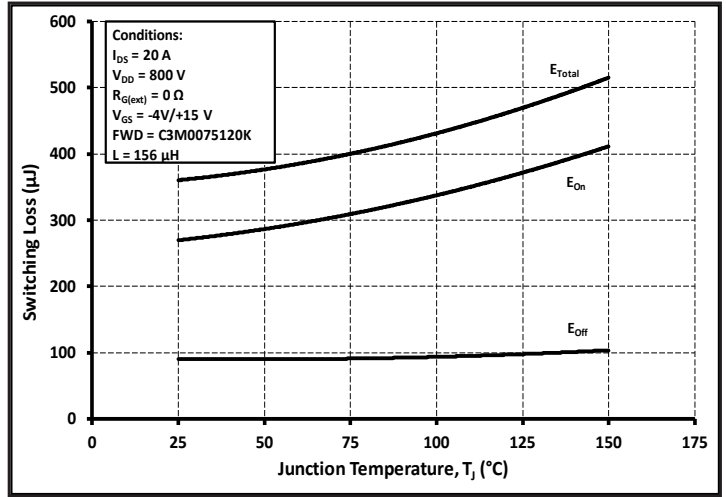

Figure 26. Clamped Inductive Switching Energy vs. Temperature

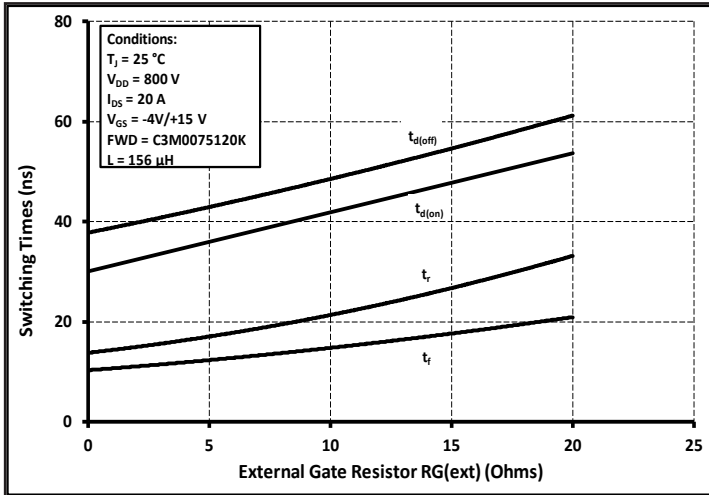

Figure 27. Switching Times vs. $R_{G(\text{ext})}$

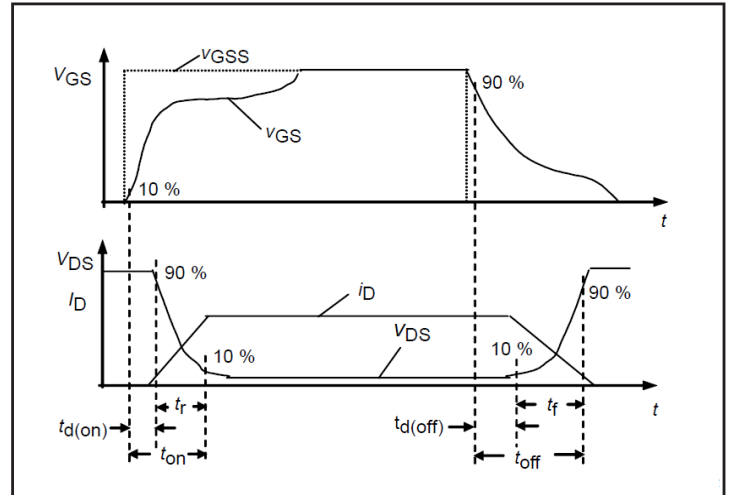

Figure 28. Switching Times Definition

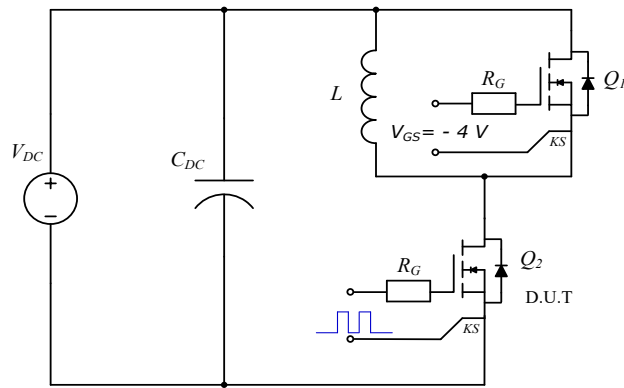
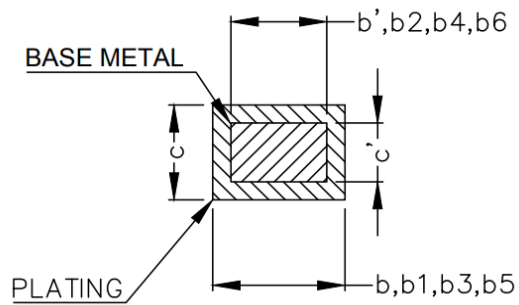
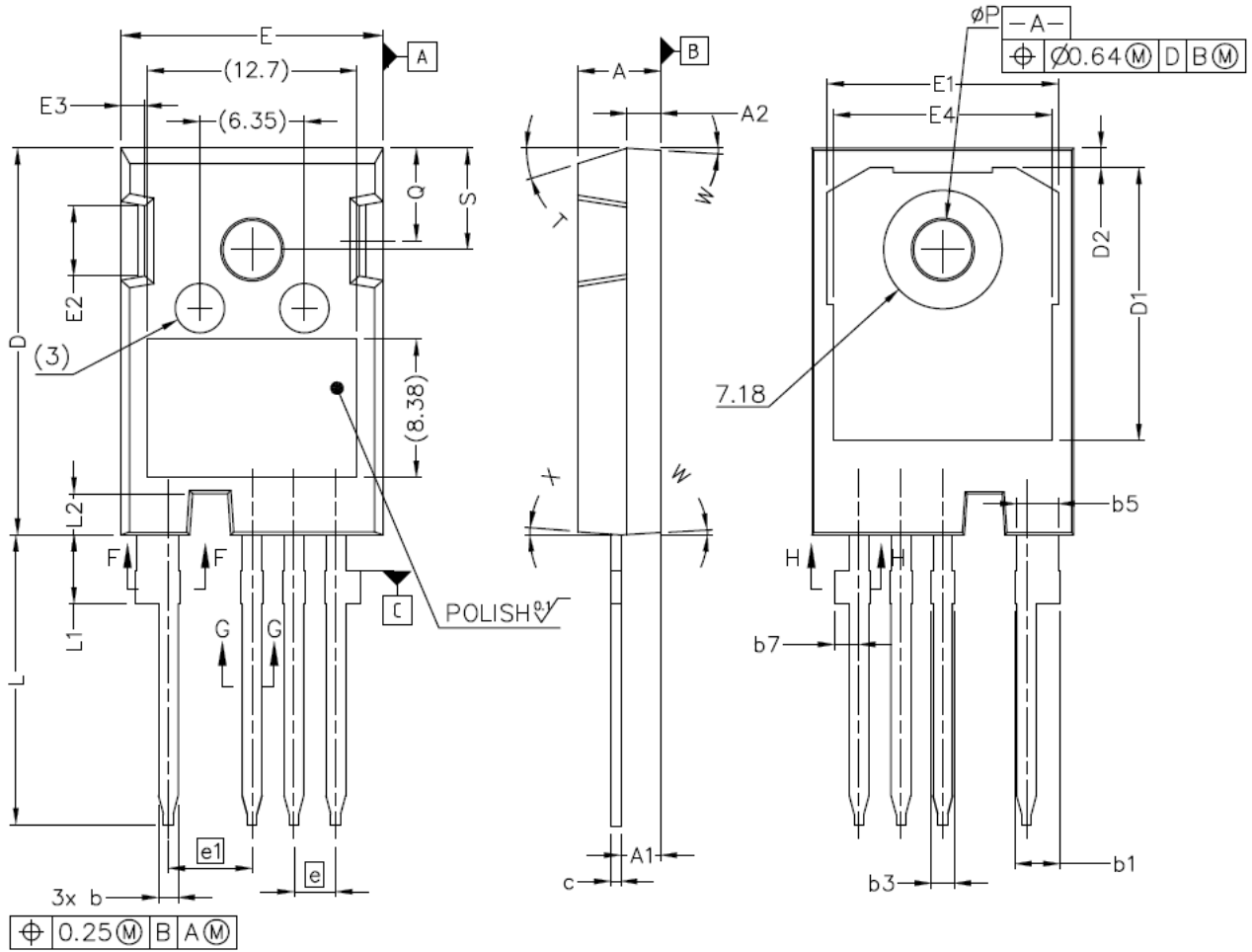

Figure 29. Clamped Inductive Switching
Waveform Test Circuit

Note (3): Turn-off and Turn-on switching energy and timing values measured using SiC MOSFET Body Diode as shown above.

Package Dimensions

Package TO-247-4L



SECTION "F-F", "G-G" AND "H-H"
SCALE: NONE

Package Dimensions

Package TO-247-4L

NOTE ;

1. ALL METAL SURFACES: TIN PLATED, EXCEPT AREA OF CUT
2. DIMENSIONING & TOLERANCEING CONFIRM TO ASME Y14.5M-1994.
3. ALL DIMENSIONS ARE IN MILLIMETERS.
ANGLES ARE IN DEGREES.
4. 'N' IS THE NUMBER OF TERMINAL POSITIONS

SYM	MILLIMETERS	
	MIN	MAX
A	4.83	5.21
A1	2.29	2.54
A2	1.91	2.16
b`	1.07	1.28
b	1.07	1.33
b1	2.39	2.94
b2	2.39	2.84
b3	1.07	1.60
b4	1.07	1.50
b5	2.39	2.69
b6	2.39	2.64
b7	1.30	1.70
c`	0.55	0.65
c	0.55	0.68
D	23.30	23.60
D1	16.25	17.65
D2	0.95	1.25
E	15.75	16.13

SYM	MILLIMETERS	
	MIN	MAX
E1	13.10	14.15
E2	3.68	5.10
E3	1.00	1.90
E4	12.38	13.43
e	2.54 BSC	
e1	5.08 BSC	
N*	4	
L	17.31	17.82
L1	3.97	4.37
L2	2.35	2.65
Ø P	3.51	3.65
Q	5.49	6.00
S	6.04	6.30
T	17.5° REF.	
W	3.5° REF.	
X	4° REF.	

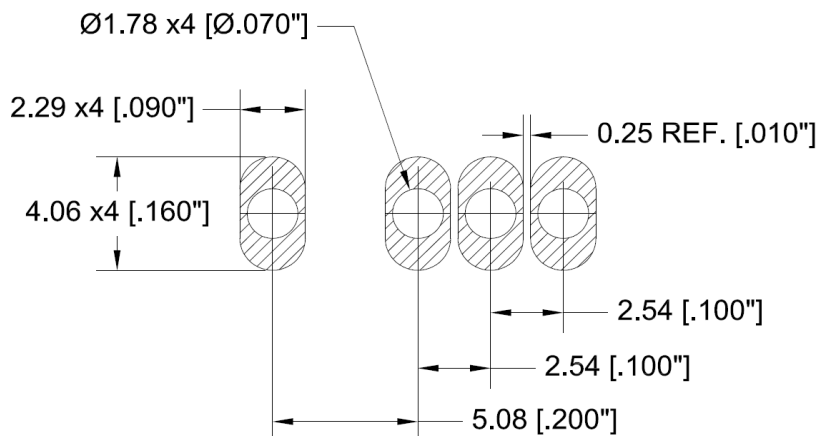

Notes

- **RoHS Compliance**
The levels of RoHS restricted materials in this product are below the maximum concentration values (also referred to as the threshold limits) permitted for such substances, or are used in an exempted application, in accordance with EU Directive 2011/65/EC (RoHS2), as implemented January 2, 2013. RoHS Declarations for this product can be obtained from your Cree representative or from the Product Documentation sections of www.cree.com.
- **REACH Compliance**
REACH substances of high concern (SVHCs) information is available for this product. Since the European Chemical Agency (ECHA) has published notice of their intent to frequently revise the SVHC listing for the foreseeable future, please contact a Cree representative to insure you get the most up-to-date REACH SVHC Declaration. REACH banned substance information (REACH Article 67) is also available upon request.
- This product has not been designed or tested for use in, and is not intended for use in, applications implanted into the human body nor in applications in which failure of the product could lead to death, personal injury or property damage, including but not limited to equipment used in the operation of nuclear facilities, life-support machines, cardiac defibrillators or similar emergency medical equipment, aircraft navigation or communication or control systems, air traffic control systems.

Related Links

- **SPIICE Models:** <http://wolfspeed.com/power/tools-and-support>
- **SiC MOSFET Isolated Gate Driver reference design:** <http://wolfspeed.com/power/tools-and-support>
- **SiC MOSFET Evaluation Board:** <http://wolfspeed.com/power/tools-and-support>