

Low-noise JFET quad operational amplifier

Datasheet - production data

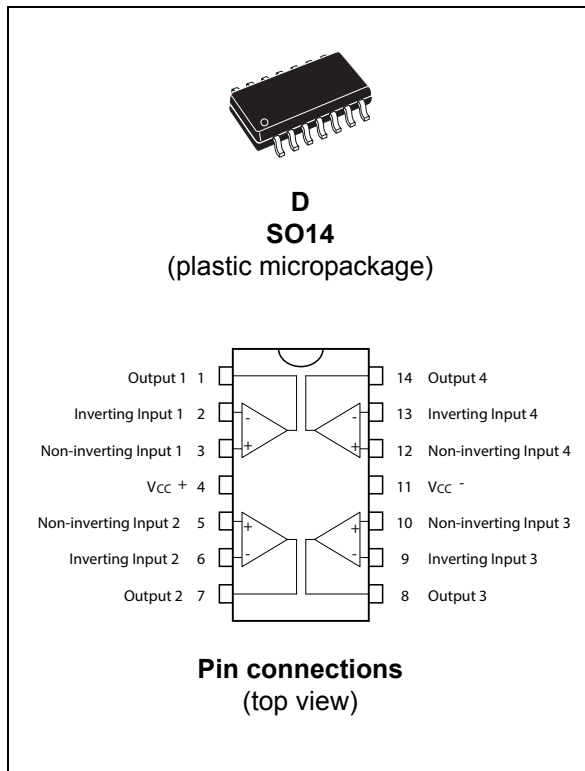

Related products

- See TL071 for single version
- See TL072 for dual version

Description

The TL074, TL074A, and TL074B are high-speed JFET input single operational amplifiers. Each of these JFET input operational amplifiers incorporates well matched, high-voltage JFET and bipolar transistors in a monolithic integrated circuit.

The devices feature high slew rates, low input bias and offset currents, and low offset voltage temperature coefficient.

Features

- Wide common-mode (up to V_{CC}^+) and differential voltage range
- Low input bias and offset current
- Low noise $e_n = 15 \text{ nV}/\sqrt{\text{Hz}}$ (typ)
- Output short-circuit protection
- High input impedance JFET input stage
- Low harmonic distortion: 0.01% (typical)
- Internal frequency compensation
- Latch up free operation
- High slew rate: $16 \text{ V}/\mu\text{s}$ (typical)

Contents

1	Schematic diagram	3
2	Absolute maximum ratings and operating conditions	4
3	Electrical characteristics	5
4	Parameter measurement information	10
5	Typical applications	11
6	Package information	13
6.1	SO14 package information	14
7	Ordering information	16
8	Revision history	17

1 Schematic diagram

Figure 1. Circuit schematic

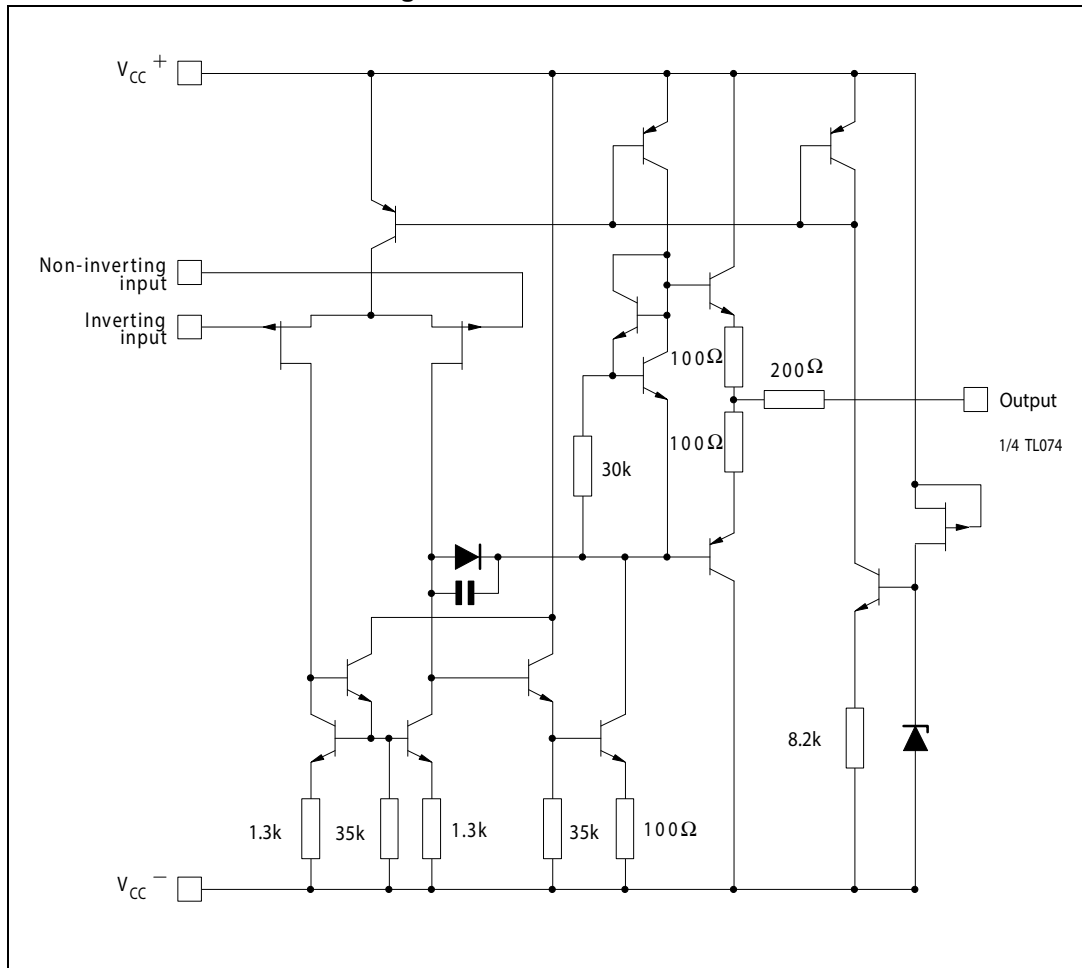

2 Absolute maximum ratings and operating conditions

Table 1. Absolute maximum ratings

Symbol	Parameter	Value		Unit
		TL074I, AI, BI	TL074C, AC, BC	
V _{CC}	Supply voltage ⁽¹⁾	±18		V
V _i	Input voltage ⁽²⁾	±15		
V _{id}	Differential input voltage ⁽³⁾	±30		
P _{tot}	Power dissipation	680		mW
R _{thja}	Thermal resistance junction to ambient ⁽⁴⁾⁽⁵⁾ SO14	105		°C/W
R _{thjc}	Thermal resistance junction to case ⁽⁴⁾⁽⁵⁾ SO14	31		
	Output short-circuit duration ⁽⁶⁾	Infinite		
T _{oper}	Operating free-air temperature range	-40 to +125	0 to +70	°C
T _{stg}	Storage temperature range	-65 to +150		
ESD	HBM: human body model ⁽⁷⁾	1		kV
	MM: machine model ⁽⁸⁾	200		V
	CDM: charged device model ⁽⁹⁾	1.5		kV

- All voltage values, except differential voltage, are with respect to the zero reference level (ground) of the supply voltages where the zero reference level is the midpoint between V_{CC}⁺ and V_{CC}⁻.
- The magnitude of the input voltage must never exceed the magnitude of the supply voltage or 15 volts, whichever is less.
- Differential voltages are the non-inverting input terminal with respect to the inverting input terminal.
- Short-circuits can cause excessive heating. Destructive dissipation can result from simultaneous short-circuits on all amplifiers.
- R_{th} are typical values.
- The output may be shorted to ground or to either supply. Temperature and/or supply voltages must be limited to ensure that the dissipation rating is not exceeded.
- Human body model: 100pF discharged through a 1.5kΩ resistor between two pins of the device, done for all couples of pin combinations with other pins floating.
- Machine model: a 200pF cap is charged to the specified voltage, then discharged directly between two pins of the device with no external series resistor (internal resistor < 5Ω), done for all couples of pin combinations with other pins floating.
- Charged device model: all pins plus package are charged together to the specified voltage and then discharged directly to the ground.

Table 2. Operating conditions

Symbol	Parameter	TL074I, AI, BI	TL074C, AC, BC	Unit
V _{CC}	Supply voltage	6 to 36		V
T _{oper}	Operating free-air temperature range	-40 to +125	0 to +70	°C

3 Electrical characteristics

Table 3. $V_{CC} = \pm 15\text{ V}$, $T_{amb} = +25\text{ }^\circ\text{C}$ (unless otherwise specified)

Symbol	Parameter	TL074I,AC,AI, BC,BI			TL074C			Unit
		Min.	Typ.	Max.	Min.	Typ.	Max.	
V_{io}	Input offset voltage ($R_S = 50\Omega$)							mV
	$T_{amb} = +25^\circ\text{C}$ TL074		3	10		3	10	
	TL074A		3	6				
	TL074B		1	3				
	$T_{min} \leq T_{amb} \leq T_{max}$ TL074			13			13	
	TL074A			7				
	TL074B			5				
DV_{io}	Input offset voltage drift		10			10		$\mu\text{V}/^\circ\text{C}$
I_{io}	Input offset current							pA nA
	$T_{amb} = +25^\circ\text{C}$ $T_{min} \leq T_{amb} \leq T_{max}$		5	100 4		5	100 10	
I_{ib}	Input bias current -note ⁽¹⁾							pA nA
	$T_{amb} = +25^\circ\text{C}$ $T_{min} \leq T_{amb} \leq T_{max}$		20	200 20		30	200 20	
A_{vd}	Large signal voltage gain $R_L = 2\text{k}\Omega$, $V_o = \pm 10\text{V}$							V/mV
	$T_{amb} = +25^\circ\text{C}$ $T_{min} \leq T_{amb} \leq T_{max}$	50 25	200		25 15	200		
SVR	Supply voltage rejection ratio ($R_S = 50\Omega$)							dB
	$T_{amb} = +25^\circ\text{C}$ $T_{min} \leq T_{amb} \leq T_{max}$	80 80	86		70 70	86		
I_{CC}	Supply current, no load							mA
	$T_{amb} = +25^\circ\text{C}$ $T_{min} \leq T_{amb} \leq T_{max}$		1.4	2.5 2.5		1.4	2.5 2.5	
V_{icm}	Input common mode voltage range	± 11	+15 -12		± 11	+15 -12		V
CMR	Common mode rejection ratio ($R_S = 50\Omega$)							dB
	$T_{amb} = +25^\circ\text{C}$ $T_{min} \leq T_{amb} \leq T_{max}$	80 80	86		70 70	86		
I_{os}	Output short-circuit current							mA
	$T_{amb} = +25^\circ\text{C}$ $T_{min} \leq T_{amb} \leq T_{max}$	10 10	40	60 60	10 10	40	60 60	
$\pm V_{opp}$	Output voltage swing							V
	$T_{amb} = +25^\circ\text{C}$ $R_L = 2\text{k}\Omega$	10	12		10	12		
	$R_L = 10\text{k}\Omega$	12	13.5		12	13.5		
	$T_{min} \leq T_{amb} \leq T_{max}$ $R_L = 2\text{k}\Omega$	10			10			
	$R_L = 10\text{k}\Omega$	12			12			
SR	Slew rate $V_{in} = 10\text{V}$, $R_L = 2\text{k}\Omega$, $C_L = 100\text{pF}$, unity gain	8	13		8	13		V/ μs

Table 3. $V_{CC} = \pm 15\text{ V}$, $T_{amb} = +25\text{ }^\circ\text{C}$ (unless otherwise specified) (continued)

Symbol	Parameter	TL074I,AC,AI, BC,BI			TL074C			Unit
		Min.	Typ.	Max.	Min.	Typ.	Max.	
t_r	Rise time $V_{in} = 20\text{mV}$, $R_L = 2\text{k}\Omega$, $C_L = 100\text{pF}$, unity gain		0.1			0.1		μs
K_{ov}	Overshoot $V_{in} = 20\text{mV}$, $R_L = 2\text{k}\Omega$, $C_L = 100\text{pF}$, unity gain		10			10		%
GBP	Gain bandwidth product $V_{in} = 10\text{mV}$, $R_L = 2\text{k}\Omega$, $C_L = 100\text{pF}$, = 100kHz	2	3		2	3		MHz
R_i	Input resistance		10^{12}			10^{12}		Ω
THD	Total harmonic distortion $f = 1\text{kHz}$, $R_L = 2\text{k}\Omega$, $C_L = 100\text{pF}$, $A_v = 20\text{dB}$, $V_o = 2V_{pp}$		0.01			0.01		%
e_n	Equivalent input noise voltage $R_S = 100\Omega$, $f = 1\text{kHz}$		15			15		$\frac{\text{nV}}{\sqrt{\text{Hz}}}$
ϕ_m	Phase margin		45			45		degrees
V_{o1}/V_{o2}	Channel separation $A_v = 100$		120			120		dB

- The input bias currents are junction leakage currents which approximately double for every 10°C increase in the junction temperature.

Figure 2. Maximum peak-to-peak output voltage versus frequency

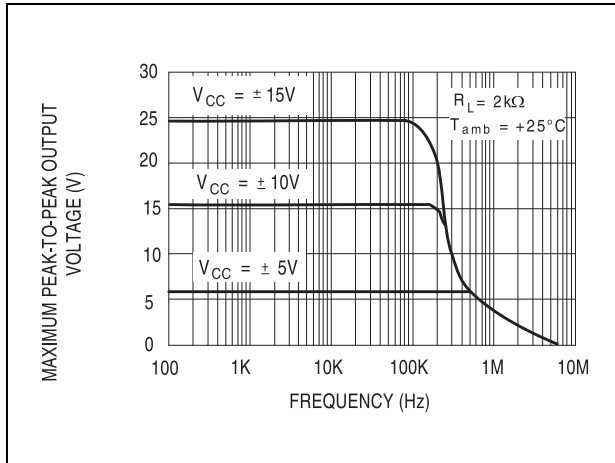

Figure 3. Maximum peak-to-peak output voltage versus frequency

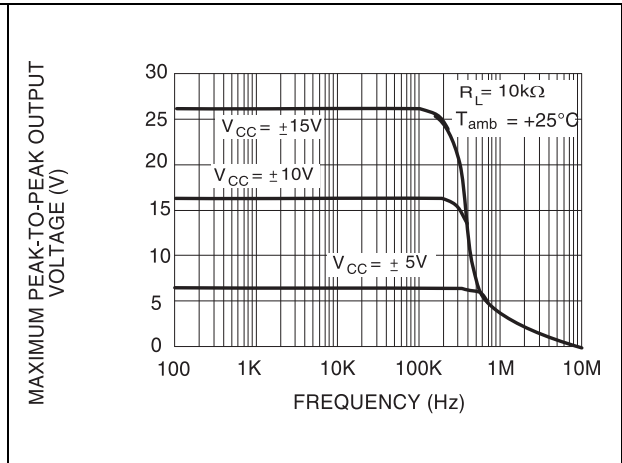

Figure 4. Maximum peak-to-peak output voltage versus frequency

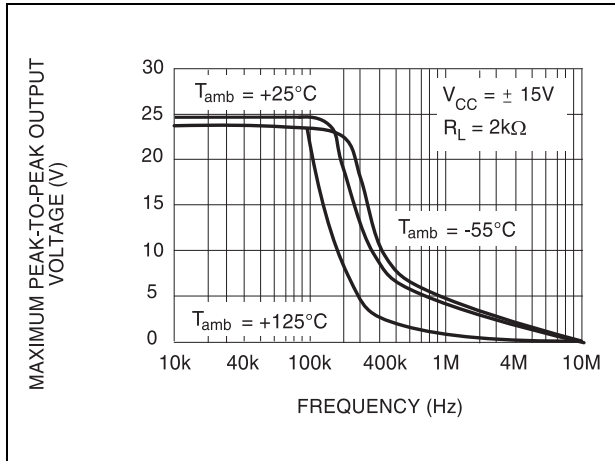

Figure 5. Maximum peak-to-peak output voltage versus free air temperature

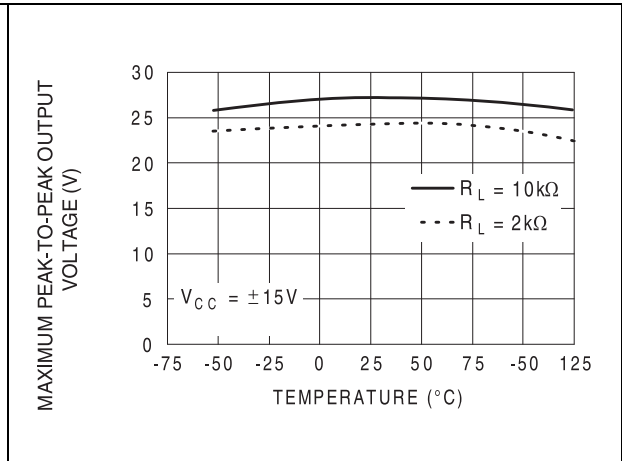

Figure 6. Maximum peak-to-peak output voltage versus load resistance

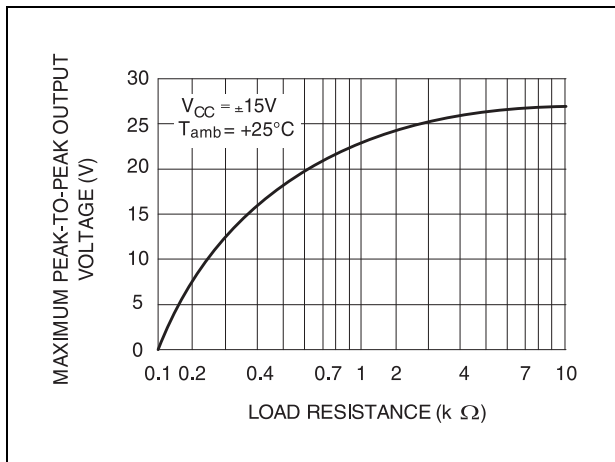

Figure 7. Maximum peak-to-peak output voltage versus supply voltage

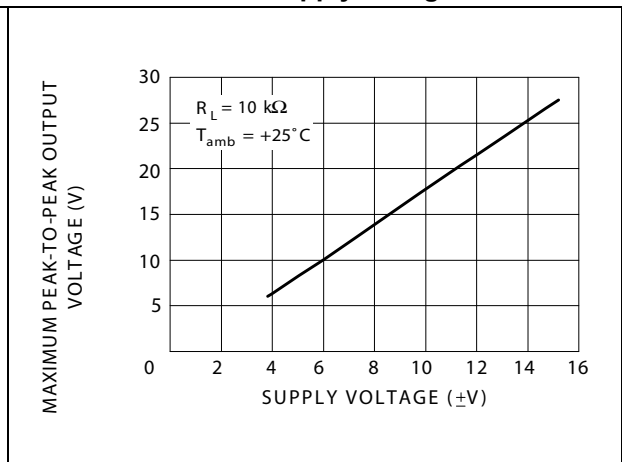

Figure 8. Input bias current versus free air temperature

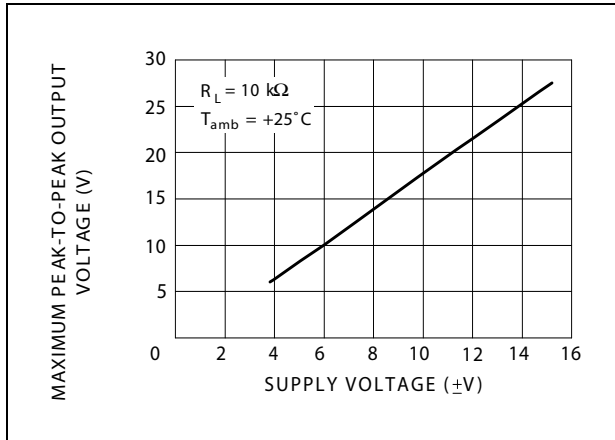

Figure 9. Large signal differential voltage amplification versus free air temperature

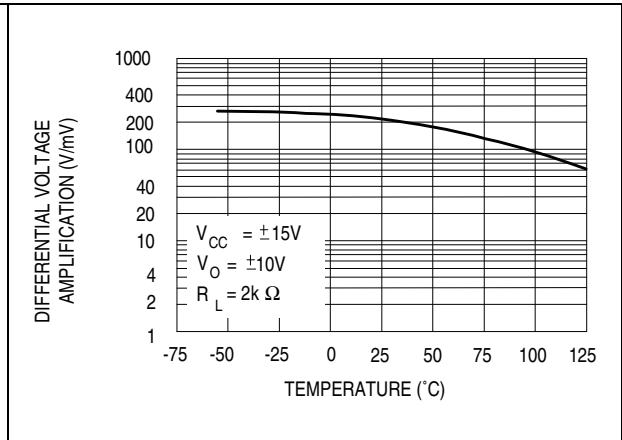

Figure 10. Large signal differential voltage amplification and phase shift versus frequency

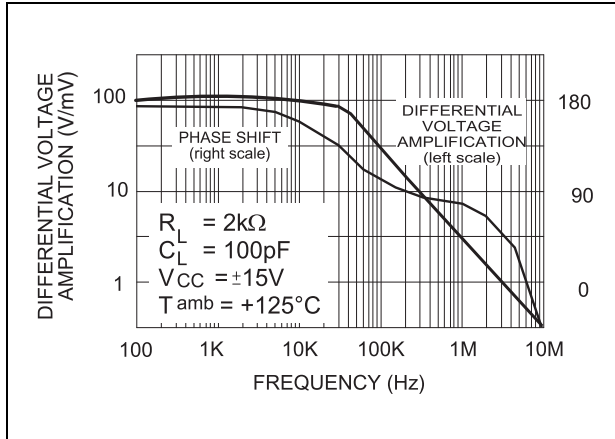

Figure 11. Total power dissipation versus free air temperature

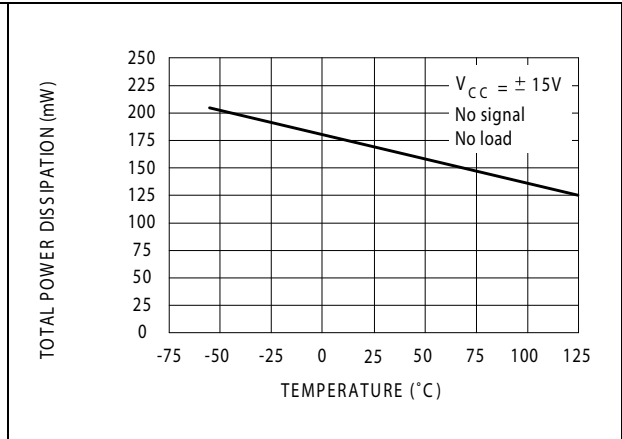

Figure 12. Supply current per amplifier versus free air temperature

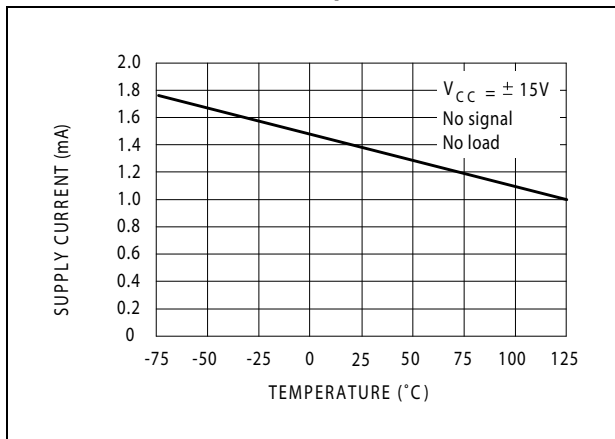

Figure 13. Common mode rejection ratio versus free air temperature

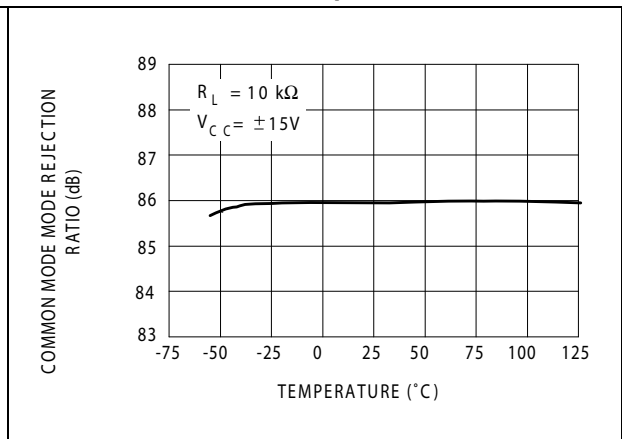

Figure 14. Voltage follower large signal pulse response

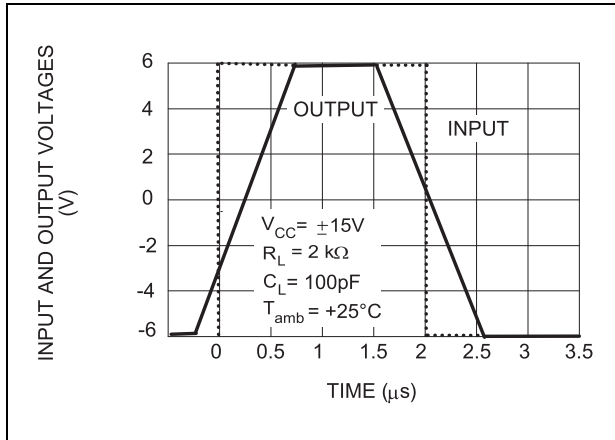

Figure 15. Output voltage versus elapsed time

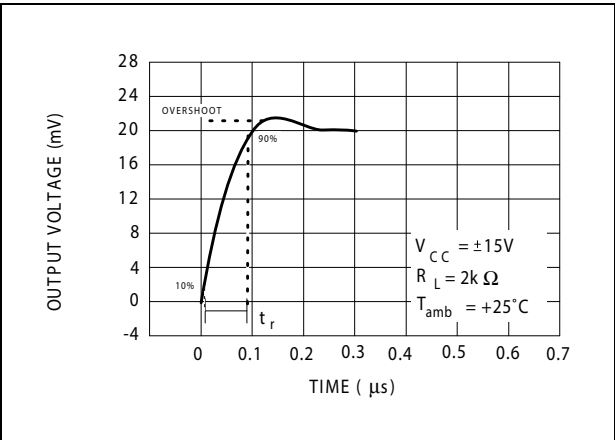

Figure 16. Equivalent input noise voltage versus frequency

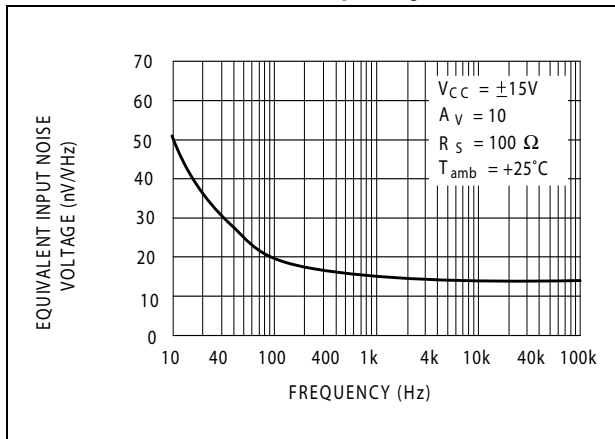
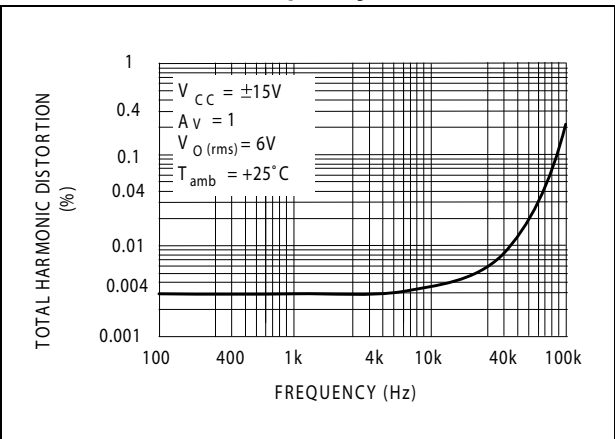

Figure 17. Total harmonic distortion versus frequency



4 Parameter measurement information

Figure 18. Voltage follower

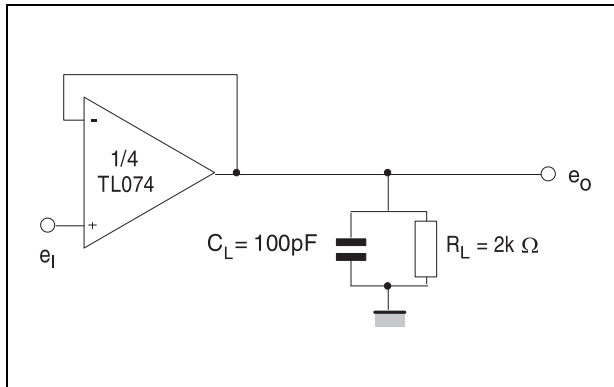

Figure 19. Gain-of-10 inverting amplifier

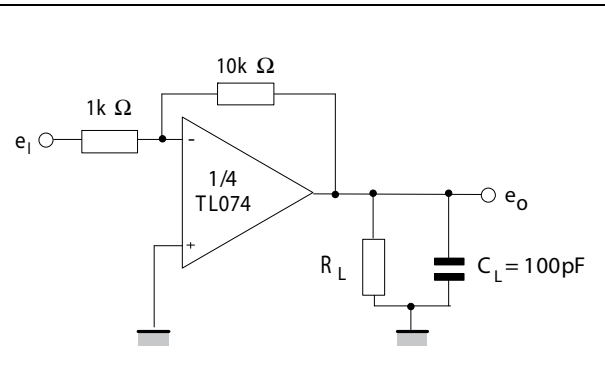
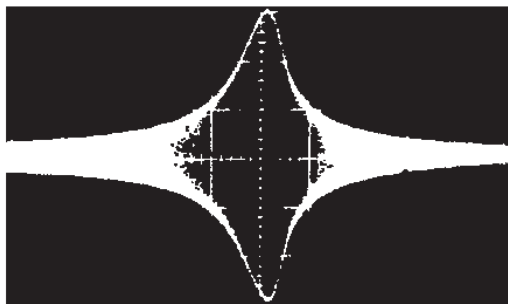
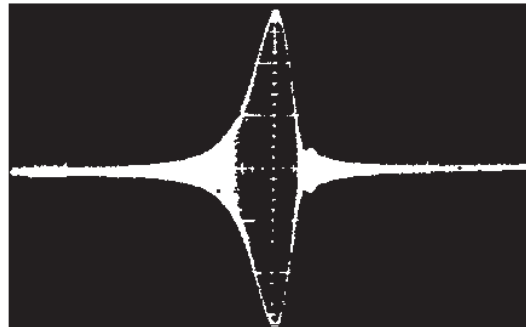

Figure 22. Output A



SECOND ORDER BANDPASS FILTER
fo = 100 kHz; Q = 30; Gain = 16

Figure 23. Output B



CASCADED BANDPASS FILTER
fo = 100 kHz; Q = 69; Gain = 16

6 Package information

In order to meet environmental requirements, ST offers these devices in different grades of ECOPACK® packages, depending on their level of environmental compliance. ECOPACK® specifications, grade definitions and product status are available at: www.st.com. ECOPACK is an ST trademark.

6.1 SO14 package information

Figure 24. SO14 package mechanical drawing

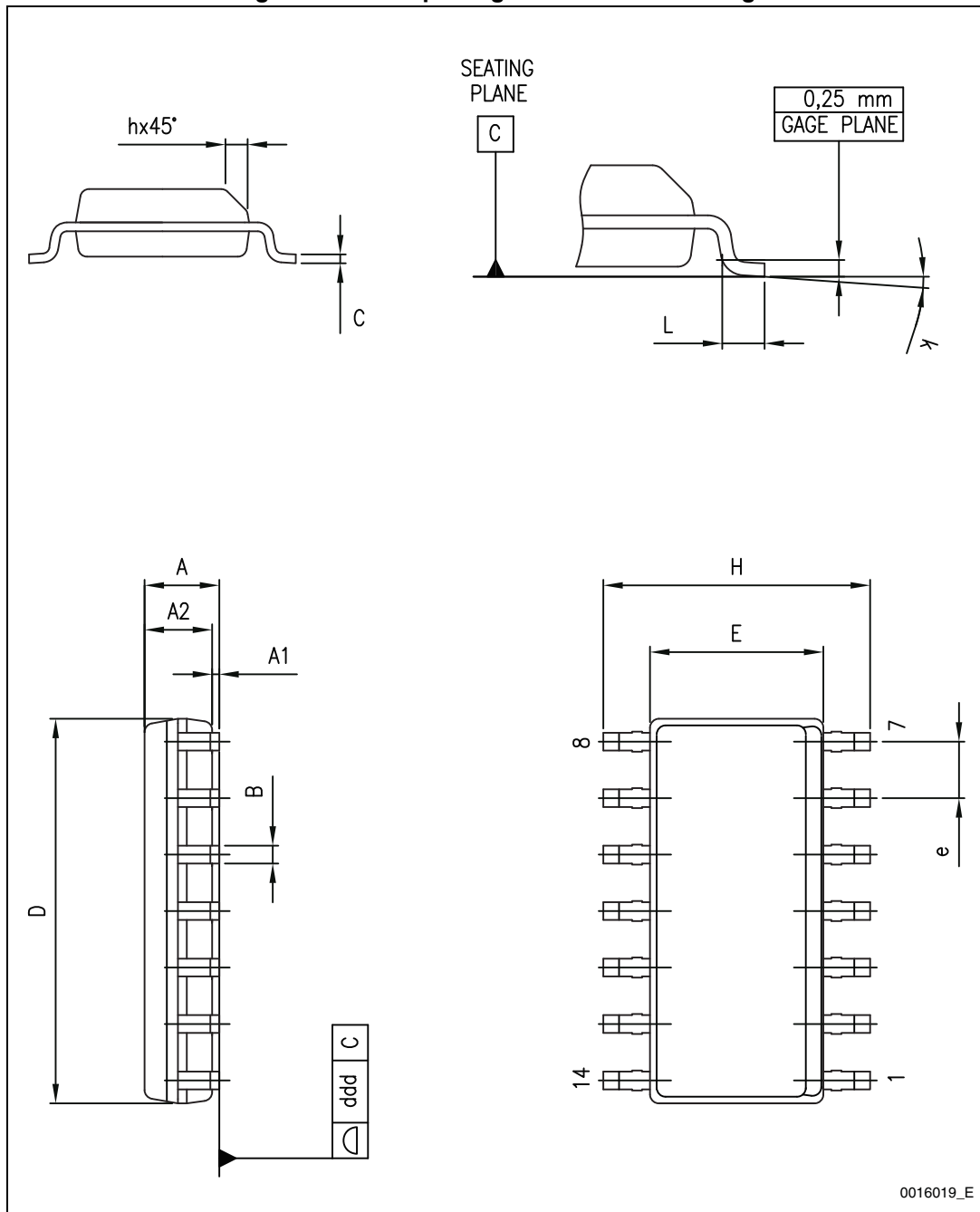

Table 4. SO14 package mechanical data

Dimensions						
Ref.	Millimeters			Inches		
	Min.	Typ.	Max.	Min.	Typ.	Max.
A	1.35		1.75	0.05		0.068
A1	0.10		0.25	0.004		0.009
A2	1.10		1.65	0.04		0.06
B	0.33		0.51	0.01		0.02
C	0.19		0.25	0.007		0.009
D	8.55		8.75	0.33		0.34
E	3.80		4.0	0.15		0.15
e		1.27			0.05	
H	5.80		6.20	0.22		0.24
h	0.25		0.50	0.009		0.02
L	0.40		1.27	0.015		0.05
k	0 °		8 °	0 °		8 °
e		0.40			0.015	
ddd			0.10			0.004

7 Ordering information

Table 5. Order codes

Order code	Temperature range	Package	Packing	Marking
TL074IDT TL074AIDT TL074BIDT	-40°C, +125°C	SO14	Tape and reel	074I
				074AI
				074BI
TL074IYDT ⁽¹⁾ TL074AIYDT ⁽¹⁾ TL074BIYDT ⁽¹⁾				074IY
				074AIY
				074BIY
TL074CDT TL074ACDT TL074BCDT	0°C, +70°C			074C
				074AC
				074BC

1. Qualified and characterized according to AEC Q100 and Q003 or equivalent, advanced screening according to AEC Q001 & Q 002 or equivalent.

8 Revision history

Table 6. Document revision history

Date	Revision	Changes
28-Mar-2001	1	Initial release.
30-Jul-2007	2	Added values for R_{thja} , R_{thjc} and ESD in Table 1: Absolute maximum ratings . Added Table 2: Operating conditions . Expanded Table 5: Order codes . Format update.
07-Jul-2008	3	Removed information concerning military temperature ranges (TL074Mx, TL074AMx, TL074BMx). Added automotive grade order codes in Table 5: Order codes .
04-Jul-2012	4	Removed commercial types TL074IYD, TL074AIYD, TL074BIYD. Updated Table 5: Order codes .
22-Nov-2013	5	Added Related products on first page Removed DIP package mechanical information Table 5: Order codes : – removed commercial types related to DIP package: TL074IN, TL074AIN, TL074BIN, TL074CN, TL074ACN, TL074BCN; – removed commercial types related to tube packing: TL074ID, TL074AID, TL074BID, TL074CD, TL074ACD, TL074BCD; – changed operating temperature range for TL074IDT, TL074AIDT, TL074BIDT, TL074IYDT, TL074AIYDT, TL074BIYDT from -40 °C, +105 °C to -40 °C, +125 °C; – updated footnote for automotive parts.

Please Read Carefully:

Information in this document is provided solely in connection with ST products. STMicroelectronics NV and its subsidiaries ("ST") reserve the right to make changes, corrections, modifications or improvements, to this document, and the products and services described herein at any time, without notice.

All ST products are sold pursuant to ST's terms and conditions of sale.

Purchasers are solely responsible for the choice, selection and use of the ST products and services described herein, and ST assumes no liability whatsoever relating to the choice, selection or use of the ST products and services described herein.

No license, express or implied, by estoppel or otherwise, to any intellectual property rights is granted under this document. If any part of this document refers to any third party products or services it shall not be deemed a license grant by ST for the use of such third party products or services, or any intellectual property contained therein or considered as a warranty covering the use in any manner whatsoever of such third party products or services or any intellectual property contained therein.

UNLESS OTHERWISE SET FORTH IN ST'S TERMS AND CONDITIONS OF SALE ST DISCLAIMS ANY EXPRESS OR IMPLIED WARRANTY WITH RESPECT TO THE USE AND/OR SALE OF ST PRODUCTS INCLUDING WITHOUT LIMITATION IMPLIED WARRANTIES OF MERCHANTABILITY, FITNESS FOR A PARTICULAR PURPOSE (AND THEIR EQUIVALENTS UNDER THE LAWS OF ANY JURISDICTION), OR INFRINGEMENT OF ANY PATENT, COPYRIGHT OR OTHER INTELLECTUAL PROPERTY RIGHT.

ST PRODUCTS ARE NOT DESIGNED OR AUTHORIZED FOR USE IN: (A) SAFETY CRITICAL APPLICATIONS SUCH AS LIFE SUPPORTING, ACTIVE IMPLANTED DEVICES OR SYSTEMS WITH PRODUCT FUNCTIONAL SAFETY REQUIREMENTS; (B) AERONAUTIC APPLICATIONS; (C) AUTOMOTIVE APPLICATIONS OR ENVIRONMENTS, AND/OR (D) AEROSPACE APPLICATIONS OR ENVIRONMENTS. WHERE ST PRODUCTS ARE NOT DESIGNED FOR SUCH USE, THE PURCHASER SHALL USE PRODUCTS AT PURCHASER'S SOLE RISK, EVEN IF ST HAS BEEN INFORMED IN WRITING OF SUCH USAGE, UNLESS A PRODUCT IS EXPRESSLY DESIGNATED BY ST AS BEING INTENDED FOR "AUTOMOTIVE, AUTOMOTIVE SAFETY OR MEDICAL" INDUSTRY DOMAINS ACCORDING TO ST PRODUCT DESIGN SPECIFICATIONS. PRODUCTS FORMALLY ESCC, QML OR JAN QUALIFIED ARE DEEMED SUITABLE FOR USE IN AEROSPACE BY THE CORRESPONDING GOVERNMENTAL AGENCY.

Resale of ST products with provisions different from the statements and/or technical features set forth in this document shall immediately void any warranty granted by ST for the ST product or service described herein and shall not create or extend in any manner whatsoever, any liability of ST.

ST and the ST logo are trademarks or registered trademarks of ST in various countries.

Information in this document supersedes and replaces all information previously supplied.

The ST logo is a registered trademark of STMicroelectronics. All other names are the property of their respective owners.

© 2013 STMicroelectronics - All rights reserved

STMicroelectronics group of companies

Australia - Belgium - Brazil - Canada - China - Czech Republic - Finland - France - Germany - Hong Kong - India - Israel - Italy - Japan - Malaysia - Malta - Morocco - Philippines - Singapore - Spain - Sweden - Switzerland - United Kingdom - United States of America

www.st.com