

UC-0

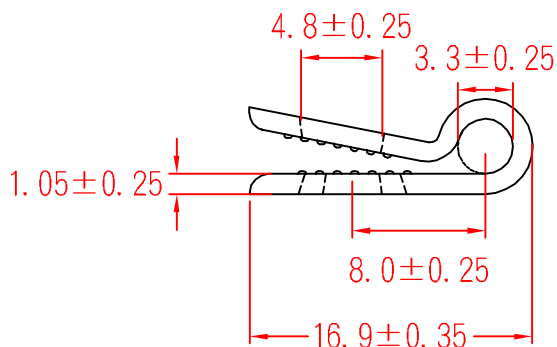
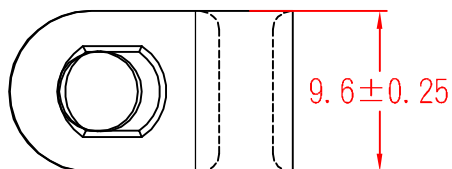

承認
KSS
96.12.05
邱平裕

審查

製圖
KSS
96.12.05
謝文通

設計

中文名
配線固定鈕

MATERIAL
UL 94V-2
NYLON 66

ITEM NO.
UC-0

SCALE

FINISH

NAME
CABLE CLAMP



(. .)

TOLERANCE
AS FIGURE



12-05-2007
DATE

REVISIONS

K002

R.NO.

使用機種



凱士士企業股份有限公司

▶ 請勿實測圖面 ◀