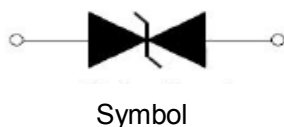
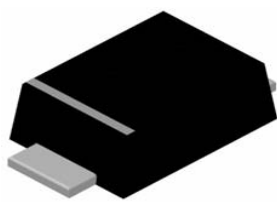

SOD-123FL

Features

Low capacitance
 Cannot be damaged by voltage
 Will not fatigue
 Eliminate voltage overshoot
 Glass passivated junction
 Halogen free and RoHS compliant

Mechanical Data

CASE: SMF(SOD-123FL) Molded Plastic
 UL Flammability Classification Rating 94V0
 Mounting Position:Any

Making Code & information

	Package	Packing Description	Packing Quantity
	SMF	Tape/Reel,7" reel	3000

Maximum Ratings & Thermal Characteristics

(Ratings at 25°C ambient temperature unless otherwise specified.)

Parameter	Symbol	Value	Units	Remarks
Peak Pulse Voltage	V_{PP}	1800	V	10/700us
Peak Pulse Current	I_{PP}	40	A	10/1000us
Peak Pulse Current	I_{PK}	150	A	8/20us
Peak One-cycle Surge Current	I_{TSM}	20	A	60Hz
Rate of Rise of Current	di/dt	500	A/us	
Typical Thermal Resistance Junction to Lead	$R_{\theta JL}$	30	°C/W	
Typical Thermal Resistance Junction to Ambient	$R_{\theta JA}$	120	°C/W	
Operating Temperature Range	T_J	-40 to 150	°C	
Storage Temperature Range	T_{STG}	-55 to 150	°C	

Electrical Characteristics

(Ratings at 25°C ambient temperature unless otherwise specified.)

Part Number	Marking	$V_S@100KV/S$ V MAX	I_{S_LMT} mA	$V_T @ I_T$ V MAX	I_T A	$I_D @ V_D$ uA MAX	V_D V	$C_O@1MHz,2V_{DC}$ pF TYP	I_H mA MIN
P0080F	P008F	25	500	4	2.2	5	6	15	30

Ratings and Characteristic Curves

(Ratings at 25°C ambient temperature unless otherwise specified).

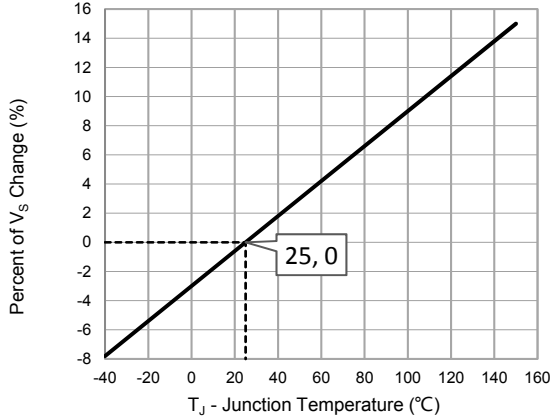

Fig.1 - Peak Pulse Current Rating

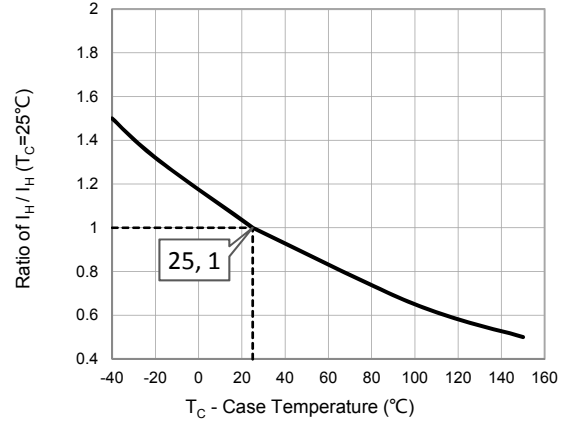

Fig.2 - Normalized DC Holding Current vs. Case Temperature

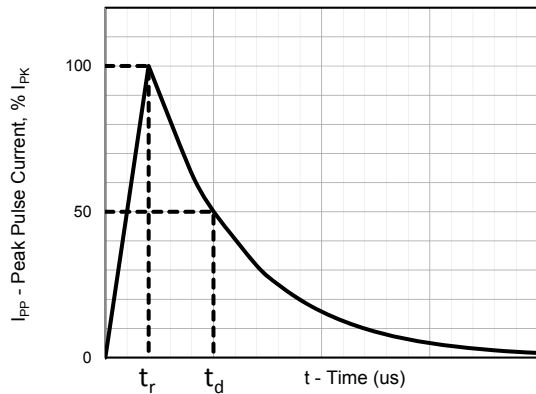

Fig.3 - tr/td us Pulse Waveform

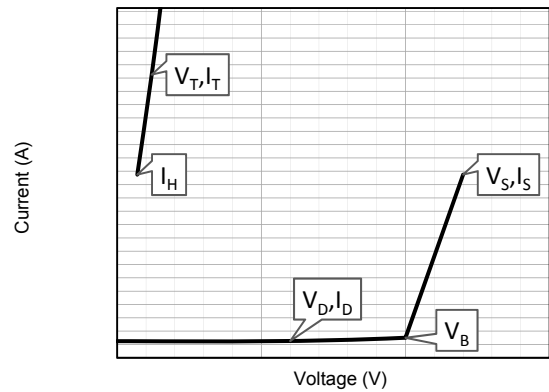

Fig.4 - VI Curve

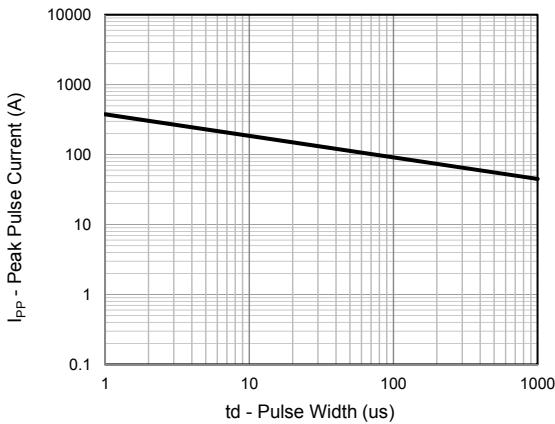

Fig.5 - Peak Pulse Current Rating

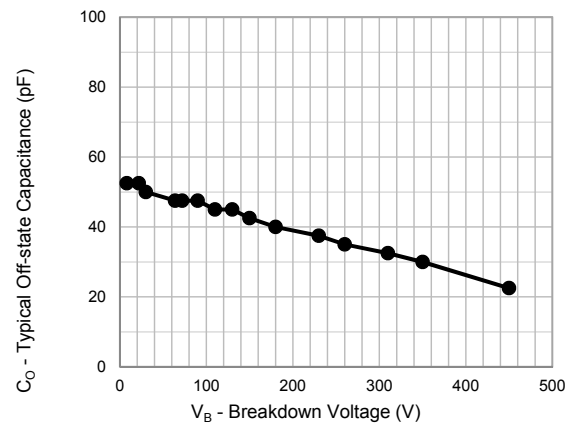
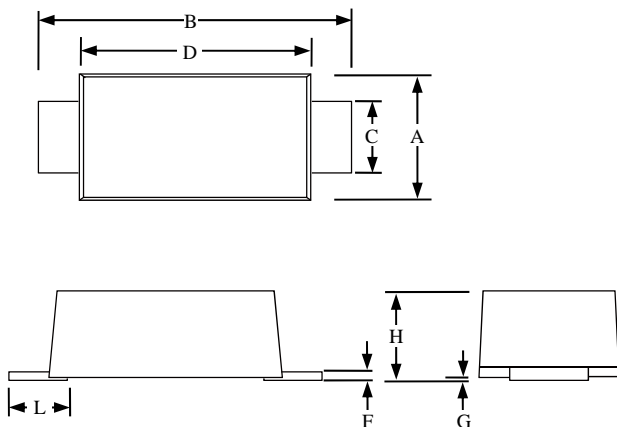

Fig.6 - Typical Off-state Capacitance

Package Outline Dimensions: SMF(SOD-123FL)



Dimension	SOD-123FL					
	Inches			Millimeters		
	MIN	NOM	MAX	MIN	NOM	MAX
A	0.059		0.079	1.5		2
B	0.134		0.154	3.4		3.9
C	0.028		0.047	0.7		1.2
D	0.098		0.114	2.5		2.9
F	0.002		0.01	0.05		0.26
G	-		0.004	-		0.1
H	0.037		0.053	0.95		1.35
L	0.014		0.035	0.35		0.9