

## SOT-23 Plastic-Encapsulate Transistors

### MMBT3904 TRANSISTOR (NPN)

#### FEATURES

- Complementary to MMBT3906

#### MAXIMUM RATINGS ( $T_a=25^{\circ}\text{C}$ unless otherwise noted)

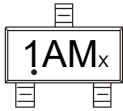

1AM= Device code  
 Solid dot = Green molding compound device,  
 if none, the normal device.  
 X= Code

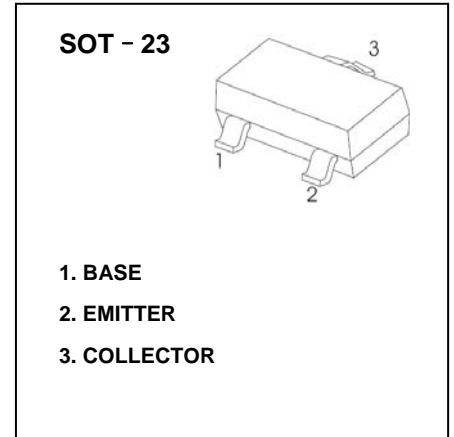

| Symbol          | Parameter  | Value    | Unit                        |
|-----------------|--|----------|-----------------------------|
| $V_{CBO}$       | Collector-Base Voltage                           | 60       | V                           |
| $V_{CEO}$       | Collector-Emitter Voltage                        | 40       | V                           |
| $V_{EBO}$       | Emitter-Base Voltage                             | 6        | V                           |
| $I_C$           | Collector Current                                | 200      | mA                          |
| $P_C$           | Collector Power Dissipation                      | 200      | mW                          |
| $R_{\theta JA}$ | Thermal Resistance From Junction To Ambient      | 625      | $^{\circ}\text{C}/\text{W}$ |
| $T_J, T_{stg}$  | Operation Junction and Storage Temperature Range | -55~+150 | $^{\circ}\text{C}$          |

#### ELECTRICAL CHARACTERISTICS ( $T_a=25^{\circ}\text{C}$ unless otherwise specified)

| Parameter                            | Symbol        | Test conditions  | Min | Typ | Max  | Unit |
|--------------------------------------|---------------|--|-----|-----|------|------|
| Collector-base breakdown voltage     | $V_{(BR)CBO}$ | $I_C=10\mu\text{A}, I_E=0$   | 60  |     |      | V    |
| Collector-emitter breakdown voltage  | $V_{(BR)CEO}$ | $I_C=1\text{mA}, I_B=0$  | 40  |     |      | V    |
| Emitter-base breakdown voltage       | $V_{(BR)EBO}$ | $I_E=10\mu\text{A}, I_C=0$   | 6   |     |      | V    |
| Collector cut-off current            | $I_{CEX}$     | $V_{CE}=30\text{V}, V_{EB(off)}=3\text{V}$                                       |     |     | 50   | nA   |
| Collector cut-off current            | $I_{CBO}$     | $V_{CB}=60\text{V}, I_E=0$   |     |     | 100  | nA   |
| Emitter cut-off current              | $I_{EBO}$     | $V_{EB}=5\text{V}, I_C=0$  |     |     | 100  | nA   |
| DC current gain                      | $h_{FE(1)}$   | $V_{CE}=1\text{V}, I_C=10\text{mA}$  | 100 |     | 300  |      |
|                                      | $h_{FE(2)}$   | $V_{CE}=1\text{V}, I_C=50\text{mA}$  | 60  |     |      |      |
|                                      | $h_{FE(3)}$   | $V_{CE}=1\text{V}, I_C=100\text{mA}$   | 30  |     |      |      |
| Collector-emitter saturation voltage | $V_{CE(sat)}$ | $I_C=50\text{mA}, I_B=5\text{mA}$  |     |     | 0.3  | V    |
| Base-emitter saturation voltage      | $V_{BE(sat)}$ | $I_C=50\text{mA}, I_B=5\text{mA}$  |     |     | 0.95 | V    |
| Transition frequency                 | $f_T$         | $V_{CE}=20\text{V}, I_C=10\text{mA}, f=100\text{MHz}$                            | 300 |     |      | MHz  |
| Delay time                           | $t_d$         | $V_{CC}=3\text{V}, V_{BE(off)}=-0.5\text{V}, I_C=10\text{mA}, I_{B1}=1\text{mA}$ |     |     | 35   | ns   |
| Rise time                            | $t_r$         | $V_{CC}=3\text{V}, V_{BE(off)}=-0.5\text{V}, I_C=10\text{mA}, I_{B1}=1\text{mA}$ |     |     | 35   | ns   |
| Storage time                         | $t_s$         | $V_{CC}=3\text{V}, I_C=10\text{mA}, I_{B1}=I_{B2}=1\text{mA}$                    |     |     | 200  | ns   |
| Fall time                            | $t_f$         | $V_{CC}=3\text{V}, I_C=10\text{mA}, I_{B1}=I_{B2}=1\text{mA}$                    |     |     | 50   | ns   |

#### CLASSIFICATION OF $h_{FE(1)}$

| HFE   | 100-300   |           |
|-------|-----------|-----------|
| RANK  | L         | H         |
| RANGE | 100 - 200 | 200 - 300 |

# Typical Characteristics

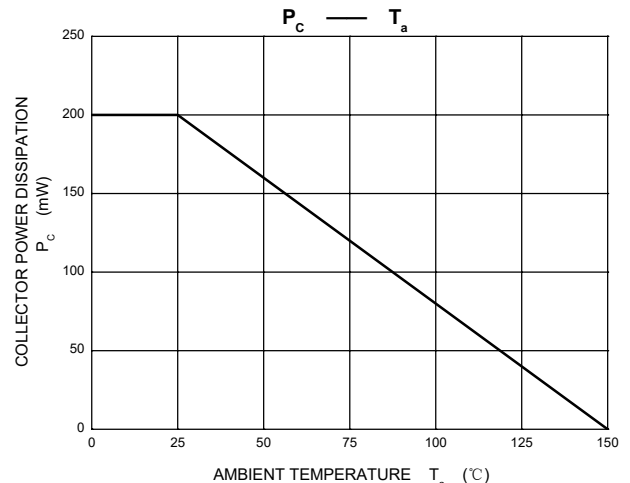
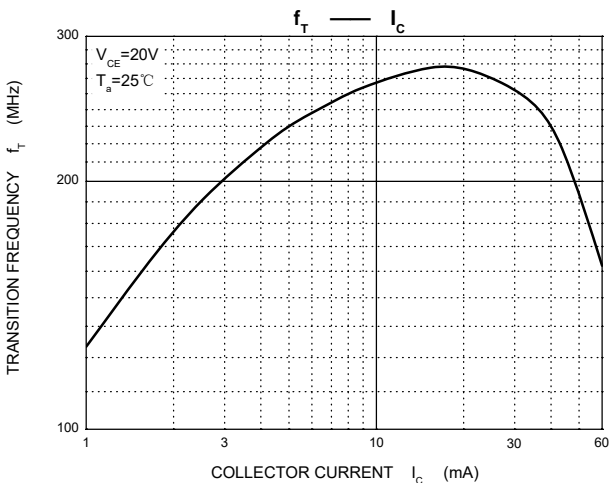
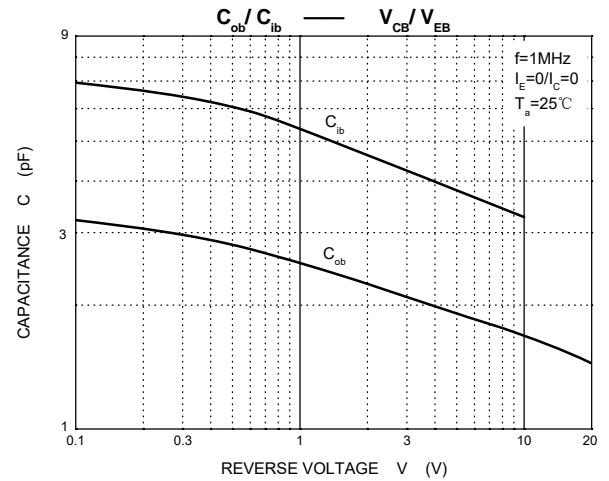
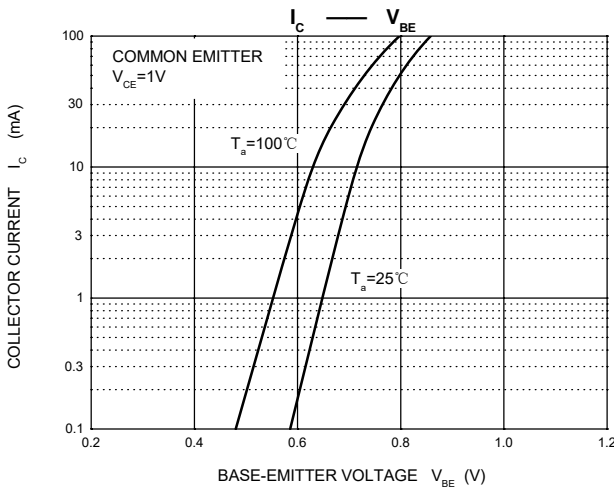
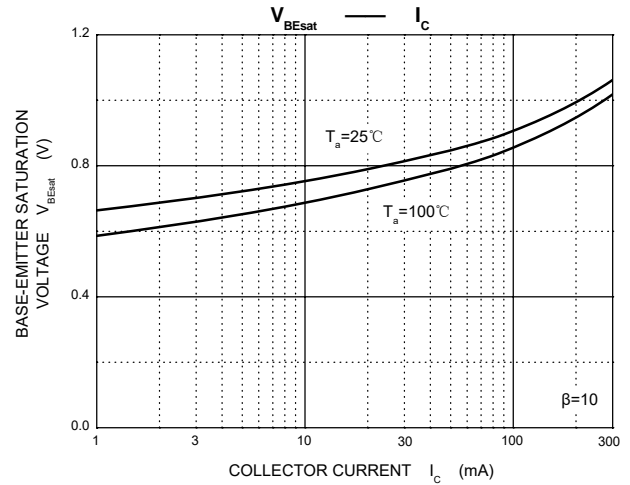
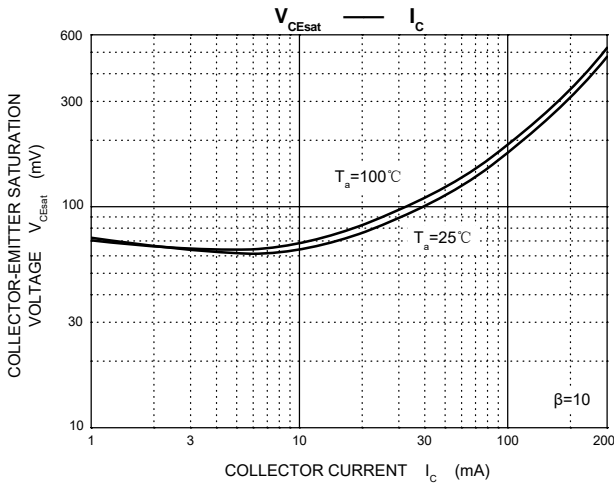
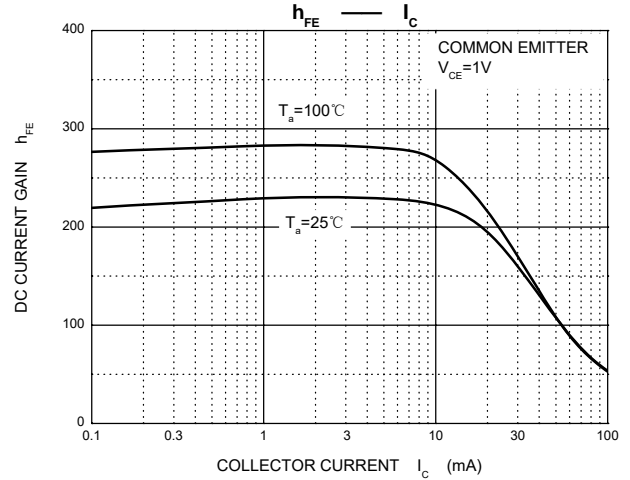
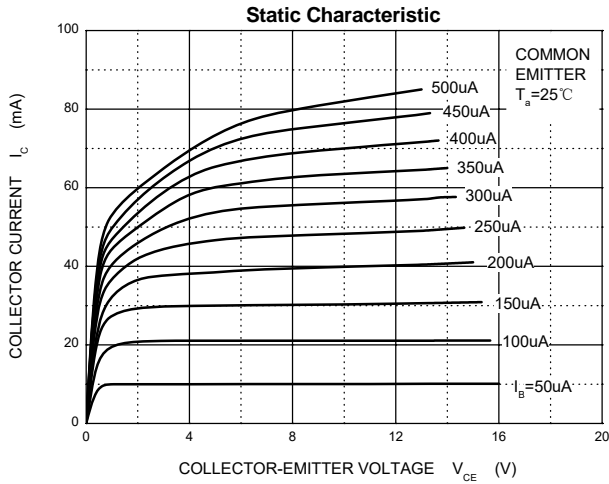

## SOT-23 Package Outline Dimensions

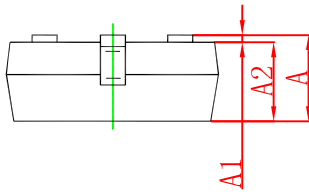
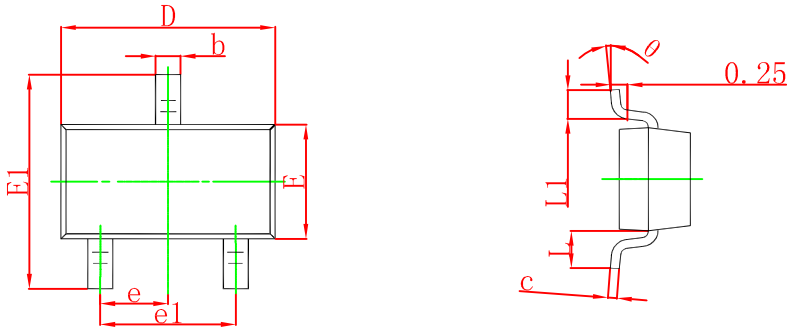

| Symbol | Dimensions In Millimeters |       | Dimensions In Inches |       |
|--------|---------------------------|-------|----------------------|-------|
|        | Min                       | Max   | Min                  | Max   |
| A      | 0.900                     | 1.150 | 0.035                | 0.045 |
| A1     | 0.000                     | 0.100 | 0.000                | 0.004 |
| A2     | 0.900                     | 1.050 | 0.035                | 0.041 |
| b      | 0.300                     | 0.500 | 0.012                | 0.020 |
| c      | 0.080                     | 0.150 | 0.003                | 0.006 |
| D      | 2.800                     | 3.000 | 0.110                | 0.118 |
| E      | 1.200                     | 1.400 | 0.047                | 0.055 |
| E1     | 2.250                     | 2.550 | 0.089                | 0.100 |
| e      | 0.950 TYP                 |       | 0.037 TYP            |       |
| e1     | 1.800                     | 2.000 | 0.071                | 0.079 |
| L      | 0.550 REF                 |       | 0.022 REF            |       |
| L1     | 0.300                     | 0.500 | 0.012                | 0.020 |
| θ      | 0°                        | 8°    | 0°                   | 8°    |

## SOT-23 Suggested Pad Layout



**Note:**

1. Controlling dimension: in millimeters.
2. General tolerance:  $\pm 0.05$  mm.
3. The pad layout is for reference purposes only.

**NOTICE**

JSCJ reserves the right to make modifications, enhancements, improvements, corrections or other changes without further notice to any product herein. JSCJ does not assume any liability arising out of the application or use of any product described herein.

# SOT-23 Tape and Reel

## SOT-23 Embossed Carrier Tape

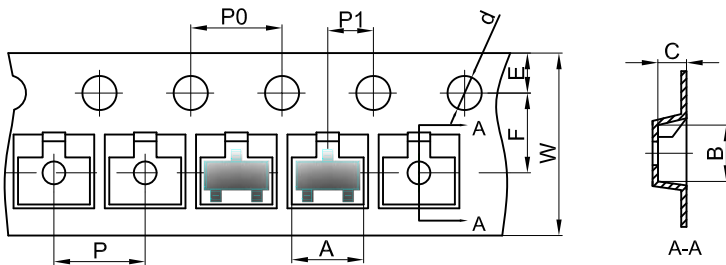

**Packaging Description:**  
 SOT-23 parts are shipped in tape. The carrier tape is made from a dissipative (carbon filled) polycarbonate resin. The cover tape is a multilayer film (Heat Activated Adhesive in nature) primarily composed of polyester film, adhesive layer, sealant, and anti-static sprayed agent. These reeled parts in standard option are shipped with 3,000 units per 7" or 17.8cm diameter reel. The reels are clear in color and is made of polystyrene plastic (anti-static coated).

| Dimensions are in millimeter |      |      |      |       |      |      |      |      |      |      |
|------------------------------|------|------|------|-------|------|------|------|------|------|------|
| Pkg type                     | A    | B    | C    | d     | E    | F    | P0   | P    | P1   | W    |
| SOT-23                       | 3.15 | 2.77 | 1.22 | Ø1.50 | 1.75 | 3.50 | 4.00 | 4.00 | 2.00 | 8.00 |

## SOT-23 Tape Leader and Trailer

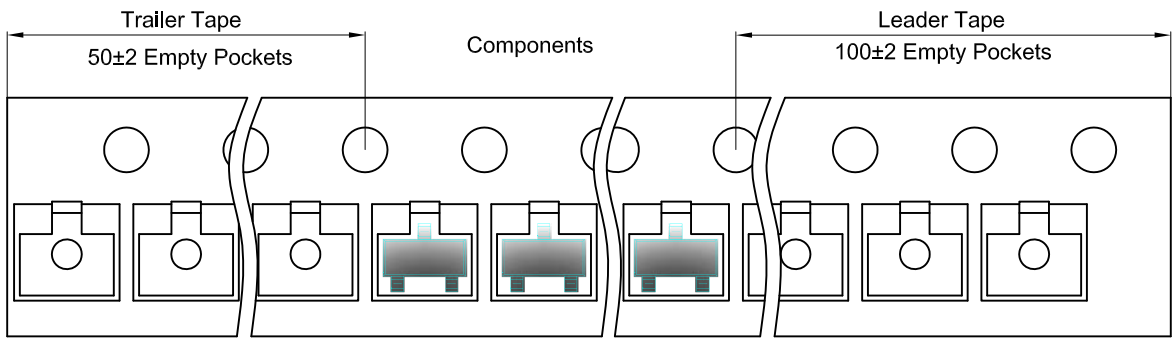

## SOT-23 Reel(S)

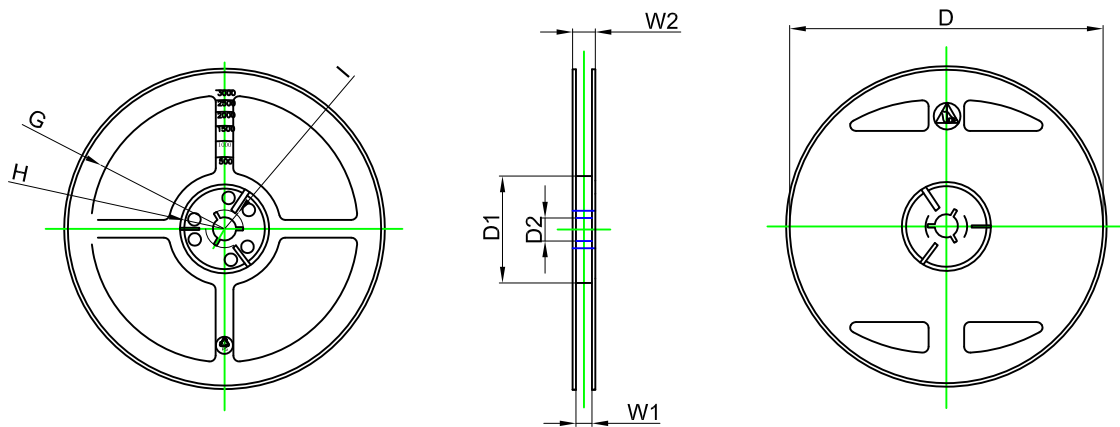

| Dimensions are in millimeter |         |       |       |        |        |       |      |       |
|------------------------------|---------|-------|-------|--------|--------|-------|------|-------|
| Reel Option                  | D       | D1    | D2    | G      | H      | I     | W1   | W2    |
| 7" Dia                       | Ø178.00 | 54.40 | 13.00 | R78.00 | R25.60 | R9.35 | 9.50 | 12.00 |

| REEL     | Reel Size | Box        | Box Size(mm) | Carton      | Carton Size(mm) | G.W.(kg) |
|----------|-----------|------------|--------------|-------------|-----------------|----------|
| 3000 pcs | 7 inch    | 45,000 pcs | 203×203×195  | 180,000 pcs | 438×438×220     |          |