

Pin No.	DIM A
TF-123-ARP9H17	1.70
TF-123-ARP9H15	1.50

Specification:

- ELECTRICAL CHARACTERISTICS
 - CONTACT RESISTANCE: 80 milliohms MAX.
 - INSULATION RESISTANCE: 1,000 Megohms MIN.
 - DIELECTRIC WITHSTANDING VOLTAGE: 500V AC FOR 1 MINUTE.
- MECHANICAL CHARACTERISTICS
 - DURABILITY: 5,000 CYCLES
- RoHS 2002/95/EC COMPLIANT.

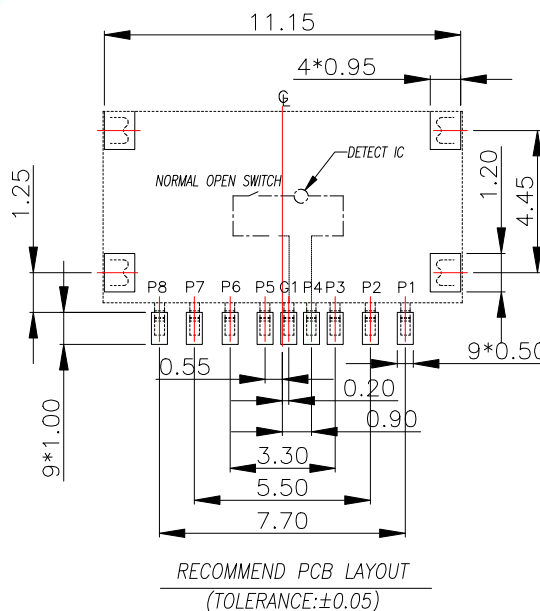
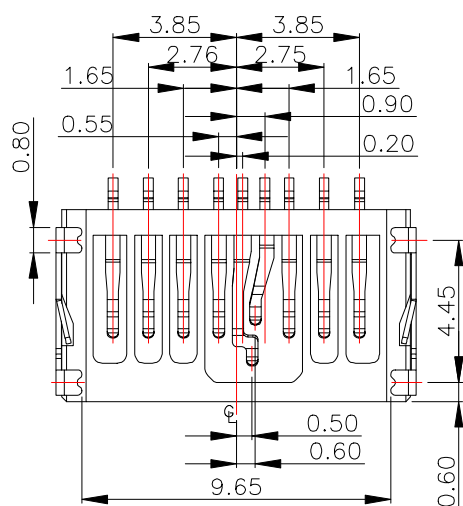
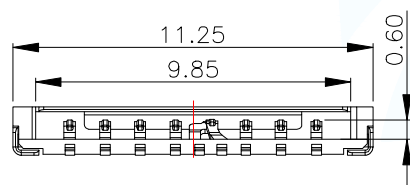
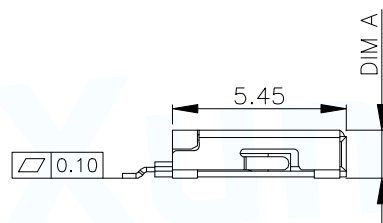

Pin No.	Pin assignment
PIN1	DAT2
PIN2	CD/DAT3
PIN3	CMD
PIN4	VDD
G1	SWITCH
PIN5	CLK
PIN6	VSS
PIN7	DAT0
PIN8	DAT1

NO	DESCRIPTION	QTY	MATERIAL	PLATING & COLOR
C	SHELL	1	STAINLESS STEEL 0.15t	Ni PLATING
B	CONTACT	9	COPPER ALLOY 0.15t	Gold Flash On Contact Area Tin plated on Solder tail All over Nickel Plated .
A	HOUSING	1	HIGH-TEMPERATURE PLASTIC UL94-V0	BLACK

MANUFACTURE DWG			东莞市讯普电子科技有限公司 DongGuan XunPu Electronics Co.,Ltd	
UNLESS OTHERWISE SPECIFIED TOLERANCES			TITLE:T-FLASH CONN 9P SIMPLE SOCKET (With Detect)	
DECIMALS:	ANGLES:		PAR	TF-123-ARP9HXX
X.:±0.50	X'.:±2'		DWN	
X.X:±0.30	X.X':±1'		CHKD	
X.XX:±0.20			APVD	
CUSTOMER COPY		SCALE1:1	UNIT:MM	REV:A
		SIZE:A4	SHEET:1F1	

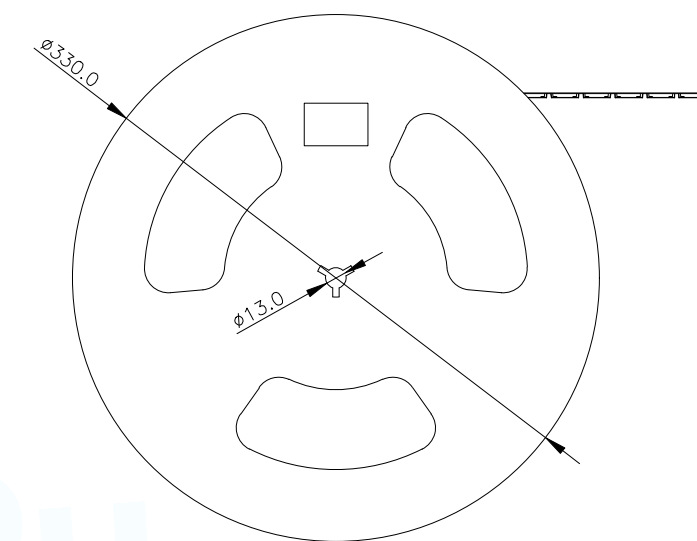
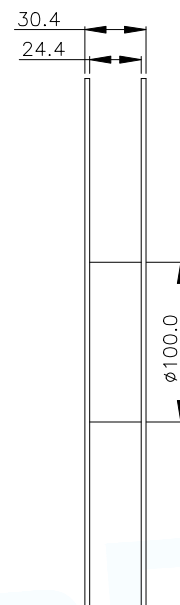
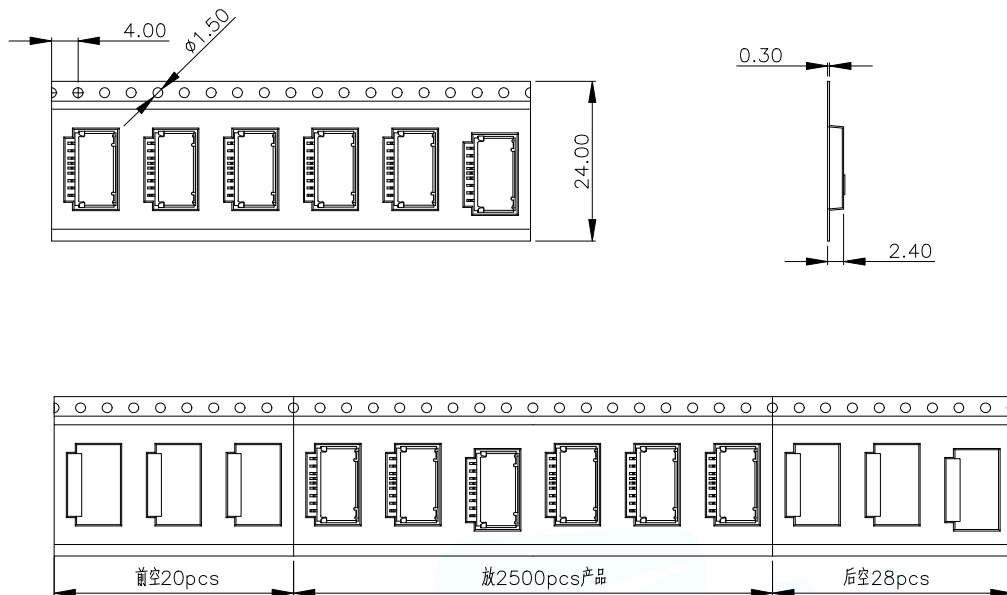

NO.1

NO.2

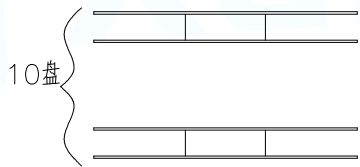
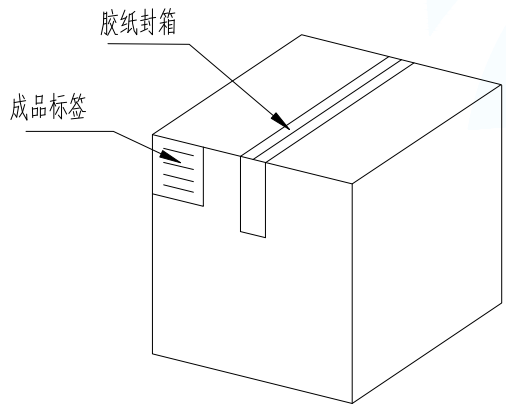

1. 材质要求:
- 1.1 纸箱的材质为A=B;外形尺寸为34*34*30;
 - 1.2 卷盘的材质为PVC,卷盘的外形尺寸为 $\phi 330*30.4$;
 - 1.3 卷带的材质为PVC,卷带的外形尺寸为24400*24.00*2.4mm;
2. 包装方式:
- 2.1 将卷带放入包装机后,前空20PCS,后放产品2500PCS,再后空28PCS.
 - 2.2 将包装好的产品从包装机上取下并包装好;
 - 2.3 把累叠好的11盘叠放入纸箱中共计27.5Kset;
 - 2.4 把包装好的成品打包封箱,并在纸箱外贴上标签

纸箱规格:340*340*300

NO.4

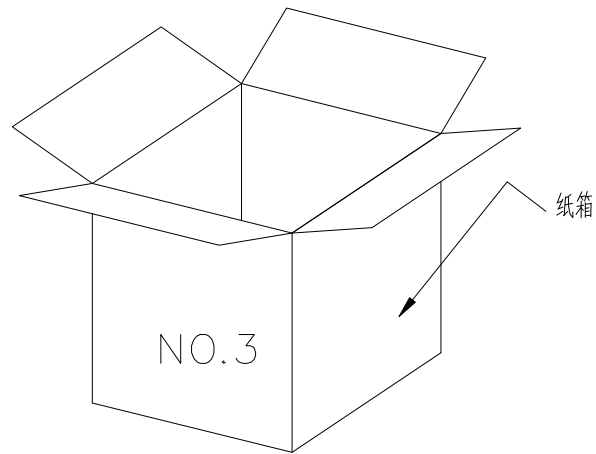

MANUFACTURE DWG			东莞市讯普电子科技有限公司 DongGuan XunPu Electronics Co.,Ltd	
UNLESS OTHERWISE SPECIFIED TOLERANCES			TITLE:T-FLASH CONN 9P SIMPLE SOCKET (With Detect)	
DECIMALS:	ANGLES:		PAR	TF-123-ARP9HXX
X.: ± 0.50	X'.: $\pm 2'$		DWN	
X.X: ± 0.30	X.X'.: $\pm 1'$	CHKD		
X.XX: ± 0.20		APVD		
CUSTOMER COPY		SCALE1:1	UNIT:MM	
		SIZE:A4	SHEET:1F1	REV:A