

V_{DS}	=	1700 V
$R_{DS(on)}$	=	650 m Ω
$I_D@25^\circ\text{C}$	=	7.0 A

Features

- High Blocking Voltage with Low On-Resistance
- High Speed Switching with Low Capacitance
- Easy to Parallel and Simple to Drive
- Ultra-low Drain-gate capacitance

Benefits

- Higher System Efficiency
- Reduced Cooling Requirements
- Increased System Reliability
- Increased System Switching Frequency

Applications

- Auxiliary Power Supplies
- Switch Mode Power Supplies
- High-voltage Capacitive

Package

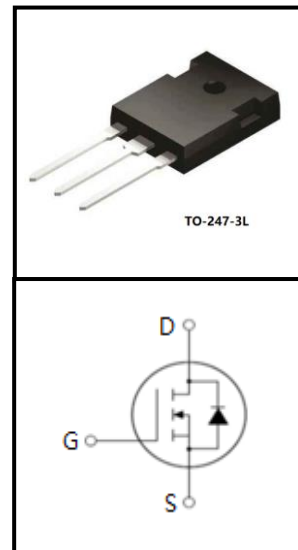

Maximum Ratings ($T_c=25^\circ\text{C}$ unless otherwise specified)

Symbol	Parameter	Value	Unit	Test Conditions	Note
V_{DSmax}	Drain-Source Voltage	1700	V	$V_{GS}=0\text{V}$, $I_D=100\mu\text{A}$	
V_{GSmax}	Gate-Source Voltage	-10/+25	V	Absolute maximum values	
V_{GSop}	Gate-Source Voltage	-5/+20	V	Recommended operational values	
I_D	Continuous Drain Current	7.0	A	$V_{GS}=20\text{V}$, $T_c=25^\circ\text{C}$	
		4.5		$V_{GS}=20\text{V}$, $T_c=100^\circ\text{C}$	
$I_{D(pulse)}$	Pulsed Drain Current	9.0	A	Pulse width t_p limited by T_{Jmax}	
P_D	Power Dissipation	62	W	$T_c=25^\circ\text{C}$, $T_J=150^\circ\text{C}$	
T_J, T_{STG}	Operating Junction and Storage Temperature	-55 to +150	$^\circ\text{C}$		

Electrical Characteristics ($T_c=25^\circ\text{C}$ unless otherwise specified)

Symbol	Parameter	Min.	Typ.	Max.	Unit	Test Conditions	Note
$V_{(BR)DSS}$	Drain-Source Breakdown Voltage	1700	/	/	V	$V_{GS}=0V, I_D=100\mu A$	
$V_{GS(th)}$	Gate Threshold Voltage	2.0	2.6	4.0	V	$V_{DS}=V_{GS}, I_D=1.0mA$	Fig. 11
		/	1.8	/		$V_{DS}=V_{GS}, I_D=1.0mA, T_J=150^\circ\text{C}$	
I_{DSS}	Zero Gate Voltage Drain Current	/	1	100	μA	$V_{DS}=1700V, V_{GS}=0V$	
I_{GSS+}	Gate-Source Leakage Current	/	10	250	nA	$V_{DS}=0V, V_{GS}=25V$	
I_{GSS-}	Gate-Source Leakage Current	/	10	250	nA	$V_{DS}=0V, V_{GS}=-10V$	
$R_{DS(on)}$	Drain-Source On-State Resistance	/	650	850	m Ω	$V_{GS}=20V, I_D=2.0A$	
		/	1300	/		$V_{GS}=20V, I_D=2.0A, T_J=150^\circ\text{C}$	
g_{fs}	Transconductance	/	1.06	/	S	$V_{DS}=20V, I_D=2.0A$	Fig. 4,5,6
		/	1.14	/		$V_{DS}=20V, I_D=2.0A, T_J=150^\circ\text{C}$	
C_{iss}	Input Capacitance	/	194	/	pF	$V_{GS}=0V$	Fig. 15,16
C_{oss}	Output Capacitance	/	13	/		$V_{DS}=1000V$	
C_{riss}	Reverse Transfer Capacitance	/	1.8	/		$f=1MHz$	
E_{oss}	C_{oss} Stored Energy	/	6.6	/	μJ	$V_{AC}=25mV$	
E_{ON}	Turn-On Switching Energy	/	5	/	mJ	$V_{DS}=1200V, V_{GS}=-5V/20V$	
E_{OFF}	Turn-Off Switching Energy	/	9.2	/		$I_D=2.0A, R_{G(ext)}=2.5\Omega, L=100\mu H$	
$t_{d(on)}$	Turn-On Delay Time	/	13.8	/	ns	$V_{DS}=1200V, V_{GS}=-5V/20V, I_D=2.0A$ $R_{G(ext)}=2.5\Omega, R_L=20\Omega$	
t_r	Rise Time	/	22.8	/			
$t_{d(off)}$	Turn-Off Delay Time	/	38	/			
t_f	Fall Time	/	14	/			
$R_{G(int)}$	Internal Gate Resistance	/	18	/	Ω	$f=1MHz, V_{AC}=25mV$	
Q_{GS}	Gate to Source Charge	/	5.4	/	nC	$V_{DS}=1200V$	
Q_{GD}	Gate to Drain Charge	/	7.6	/		$V_{GS}=-5V/20V$	
Q_G	Total Gate Charge	/	23	/		$I_D=2.0A$	

Reverse Diode Characteristics

Symbol	Parameter	Typ.	Max.	Unit	Test Conditions	Note
V_{SD}	Diode Forward Voltage	4.2	/	V	$V_{GS}=-5V, I_{SD}=25A$	Fig. 8,9,10
		3.9	/		$V_{GS}=-5V, I_{SD}=25A, T_J=150^\circ\text{C}$	
I_S	Continuous Diode Forward Current	/	7.0	A	$T_c=25^\circ\text{C}$	
t_{rr}	Reverse Recover Time	25	/	ns	$V_R=1200V, I_{SD}=2.0A$	
Q_{rr}	Reverse Recovery Charge	15	/	nC		
I_{rrm}	Peak Reverse Recovery Current	2.8	/	A		

Thermal Characteristics

Symbol	Parameter	Typ.	Max.	Unit	Test Conditions	Note
$R_{\theta JC}$	Thermal Resistance from Junction to Case	1.8	/	$^\circ\text{C/W}$		
$R_{\theta JA}$	Thermal Resistance from Junction to Ambient	/	40			

Typical Performance

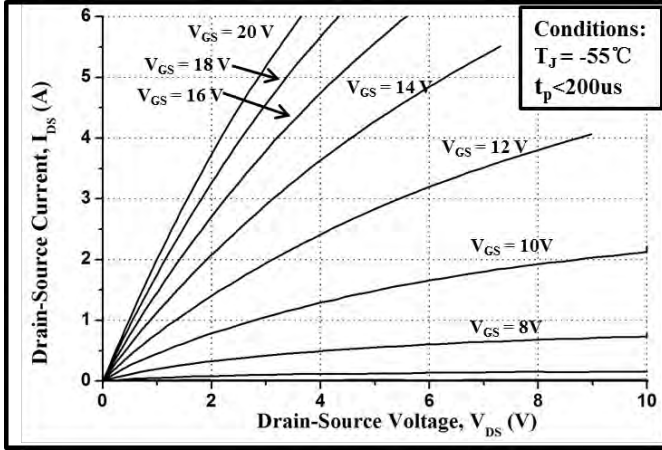

Figure 1. Output Characteristics $T_J = -55\text{ }^\circ\text{C}$

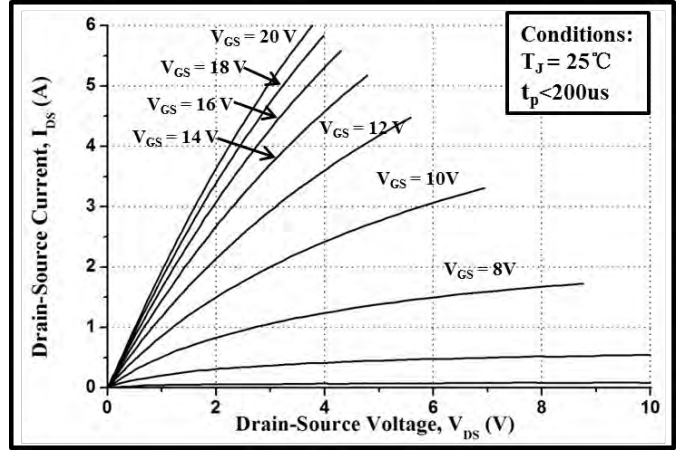

Figure 2. Output Characteristics $T_J = 25\text{ }^\circ\text{C}$

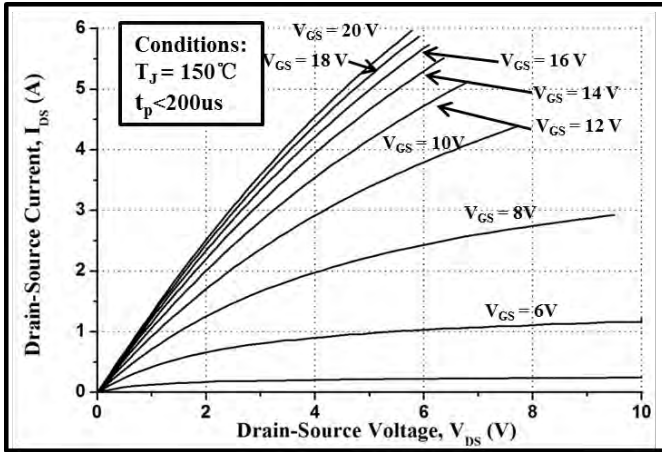

Figure 3. Output Characteristics $T_J = 150\text{ }^\circ\text{C}$

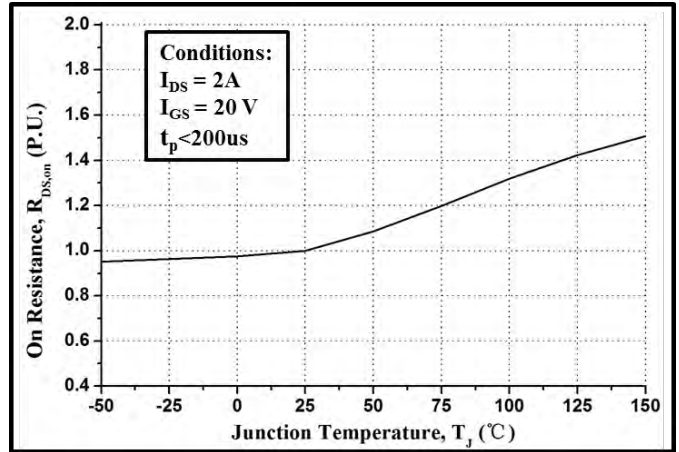

Figure 4. Normalized On-Resistance vs. Temperature

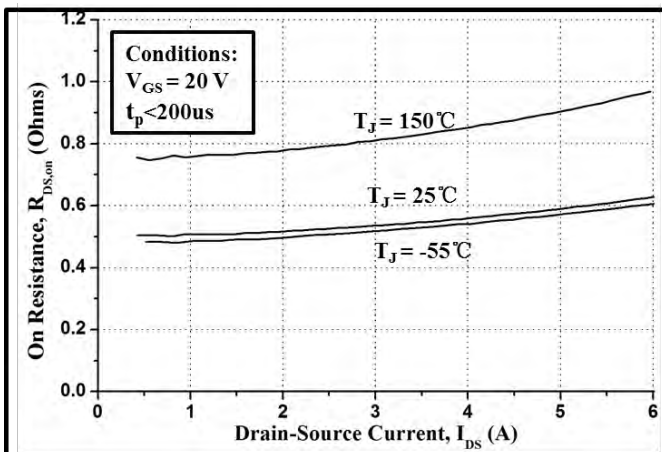

Figure 5. On-Resistance vs. Drain Current
For Various Temperatures

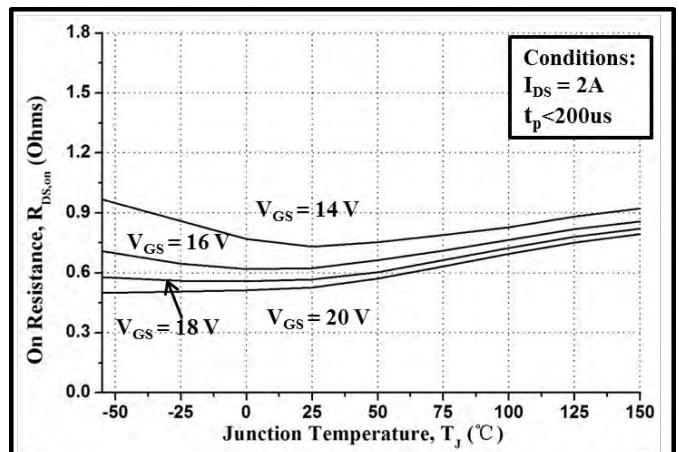

Figure 6. On-Resistance vs. Temperature
For Various Gate Voltage

Typical Performance

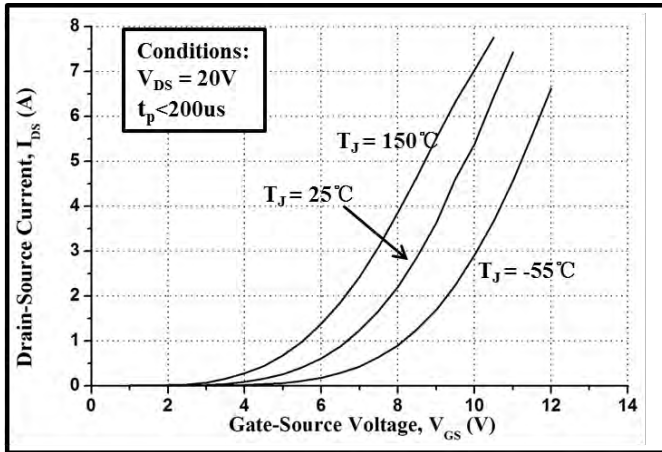

Figure 7. Transfer Characteristic for Various Junction Temperatures

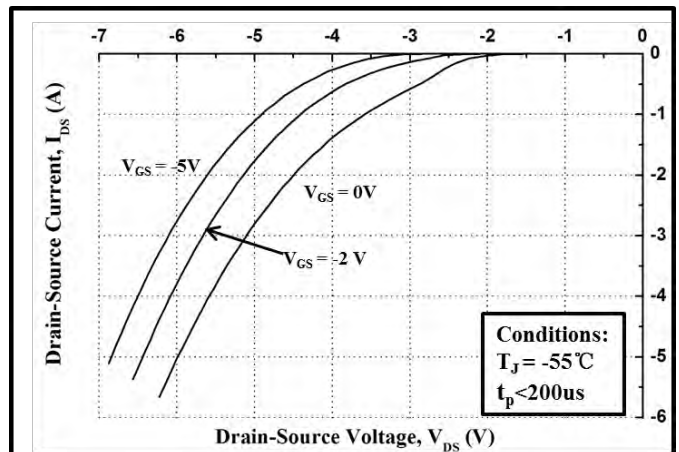

Figure 8. Body Diode Characteristic at -55 °C

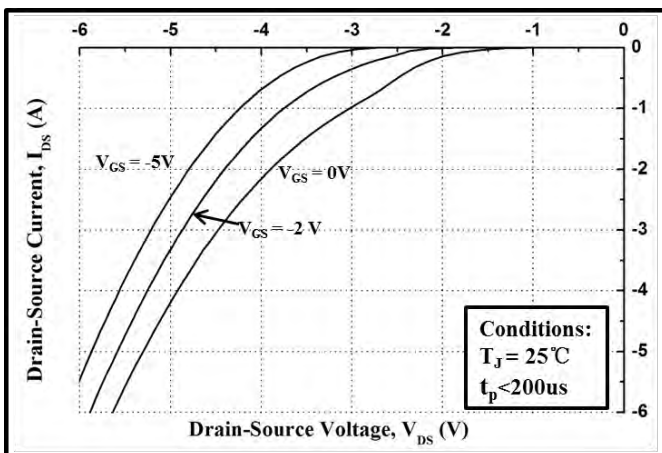

Figure 9. Body Diode Characteristic at 25 °C

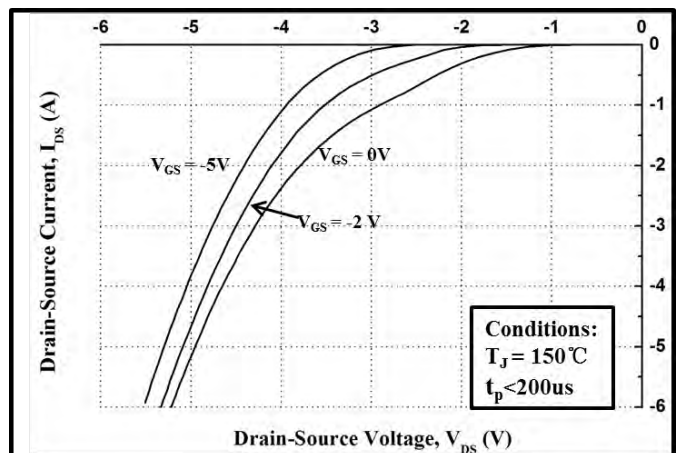

Figure 10. Body Diode Characteristic at 150 °C

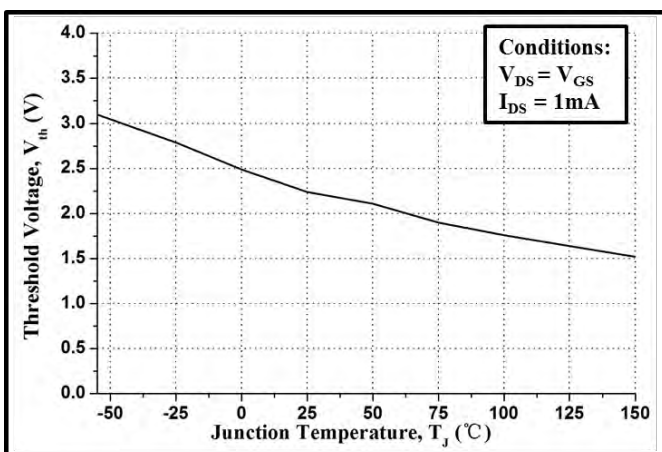

Figure 11. Threshold Voltage vs. Temperature

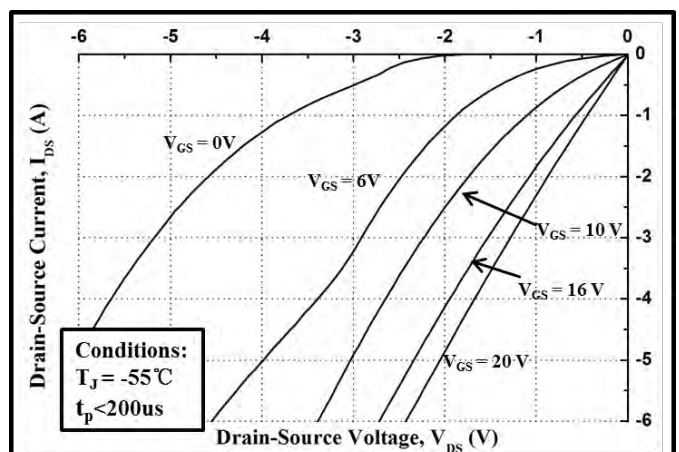

Figure 12. 3rd Quadrant Characteristic at -55 °C

Typical Performance

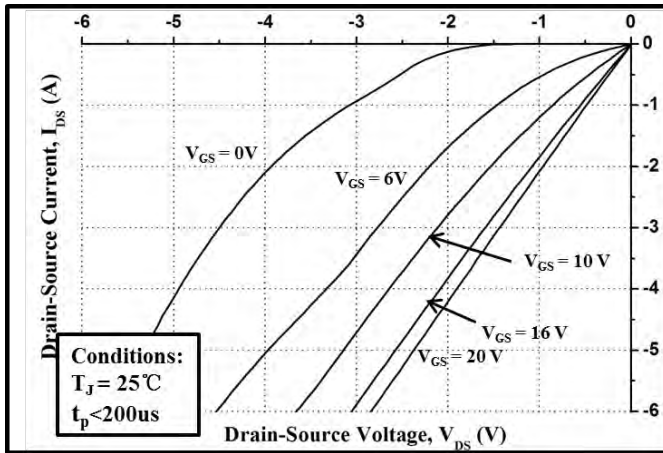

Figure 13. 3rd Quadrant Characteristic at 25 °C

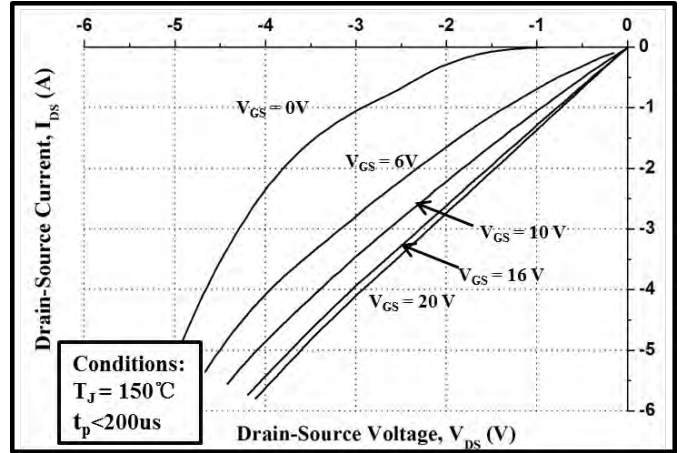

Figure 14. 3rd Quadrant Characteristic at 150 °C

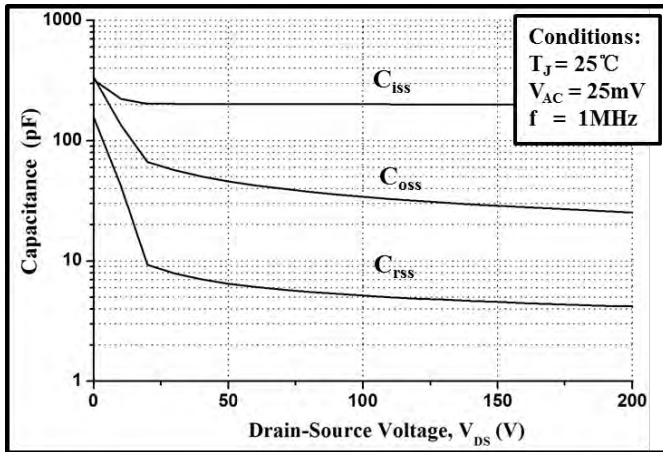

Figure 15. Capacitances vs. Drain-Source Voltage (0 - 200V)

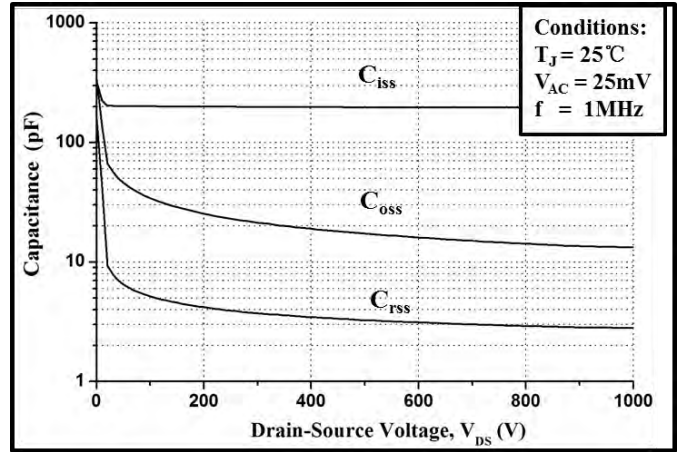

Figure 16. Capacitances vs. Drain-Source Voltage (0 - 1000V)

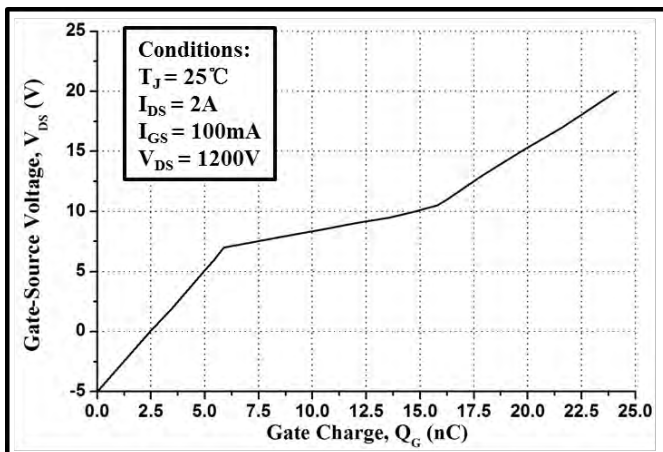

Figure 17. Gate Charge Characteristic

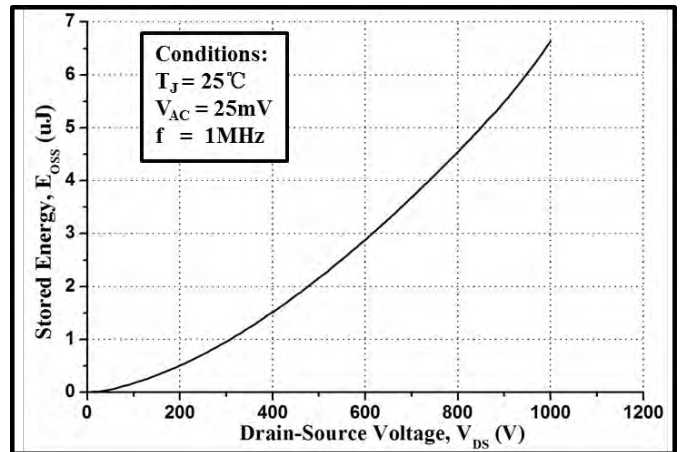
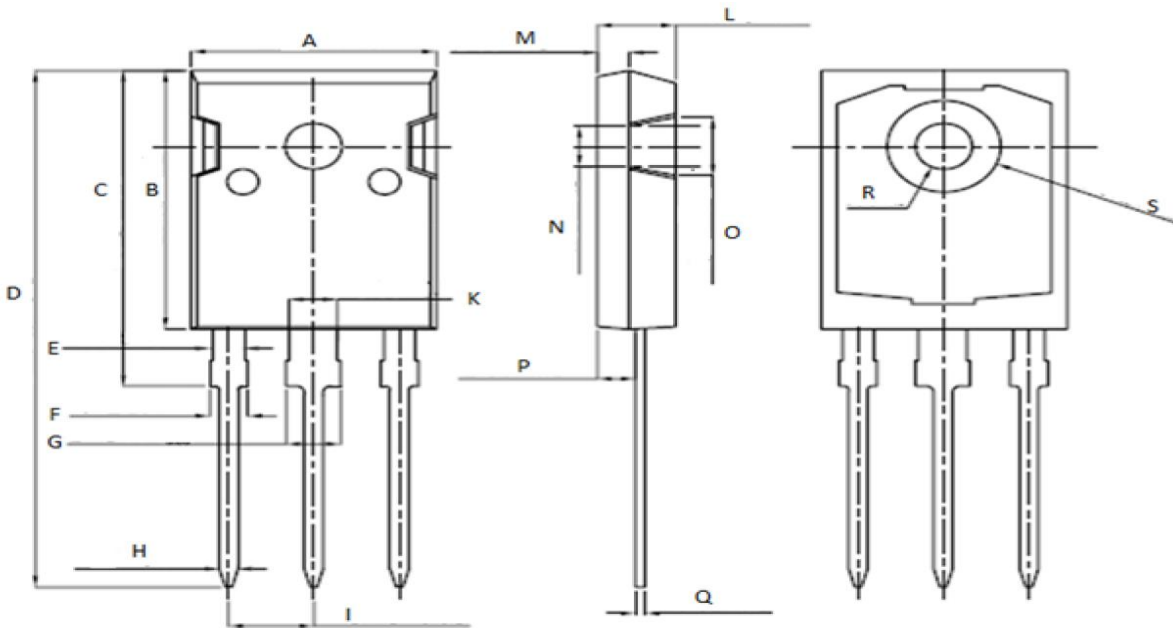

Figure 18. Output Capacitor Stored Energy

Package Dimensions

Package TO-247-3



Unit: mm		
Symbol	Min.	Max.
A	15.95	16.25
B	20.85	21.25
C	20.95	21.35
D	40.5	40.9
E	1.9	2.1
F	2.1	2.25
G	3.1	3.25
H	1.1	1.3
I	5.40	5.50

Unit: mm		
Symbol	Min.	Max.
K	2.90	3.10
L	4.90	5.30
M	1.90	2.10
N	4.50	4.70
O	5.40	5.60
P	2.29	2.49
Q	0.51	0.71
R	φ 3.5	φ 3.7
S	φ 7.1	φ 7.3