

外形尺寸 Shape and Dimensions

- 尺寸：见图 1 和表 1
- PCB 焊盘：见图 2 和表 1
- Dimensions: See Fig.1 and Table 1.
- Recommended PCB pattern for reflow soldering: See Fig.2 and Table 1



图 1 Fig.1



图 2 Fig.2

表 1 (Table 1)

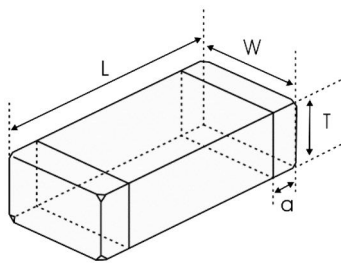
单位 unit: inch[mm]

类别 Type	L	W	T	a	A	B	C
0603 [1608]	0.063±0.006 [1.6±0.15]	0.031±0.006 [0.8±0.15]	0.031±0.006 [0.8±0.15]	0.012±0.008 [0.3±0.2]	[0.6-0.8]	[0.6-0.7]	[0.6-0.8]

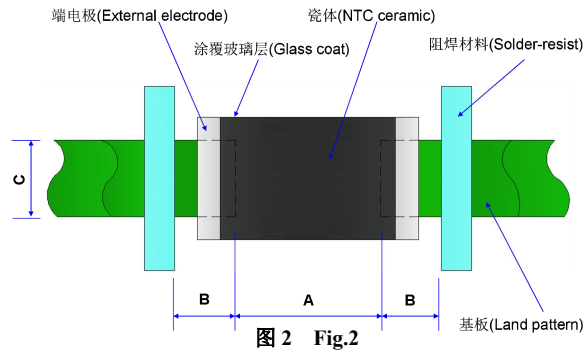
电气特性 Electrical Characteristics

型号 Part No	电阻值 Resistance (25°C) (kΩ)	B 常数 B Constant (25/50°C) (K)	B 常数 B Constant (25/85°C) (K)	允许工作电流 Permissible Operating Current (25°C) (mA)	耗散系数 Dissipation Factor (mW/°C)	热时间常数 Thermal Time Constant (s)	额定功率 Rated Electric Power(25°C) (mW)	工作温度 Operating ambient temperature (°C)
KNTC0603/10KF3950	10±1%	3950±1%	3987	0.31	1.0	<5	100	-40~+125

检验和测试程序

测试条件

如无特别规定，检验和测试的标准大气环境条件如下：

- 环境温度：20±15℃；
- 相对湿度：65±20%；
- 气压：86 kPa~106 kPa

如果对测试结果有异议，则在下述条件下测试：

- 环境温度：25±2℃；
- 相对湿度：65±5%
- 气压：86kPa ~ 106kPa

检查设备

外观检查：20 倍放大镜；

阻值检查：热敏电阻测试仪

Test and Measurement Procedures

Test Conditions

Unless otherwise specified, the standard atmospheric conditions for measurement/test as:

- Ambient Temperature: 20±15℃
- Relative Humidity: 65±20%
- Air Pressure: 86kPa to 106kPa

If any doubt on the results, measurements/tests should be made within the following limits:

- Ambient Temperature: 25±2℃
- Relative Humidity: 65±5%
- Air Pressure: 86kPa to 106kPa

Inspection Equipment

Visual Examination: 20× magnifier

Resistance value test: Thermistor resistance tester

电性测试 Electrical Test

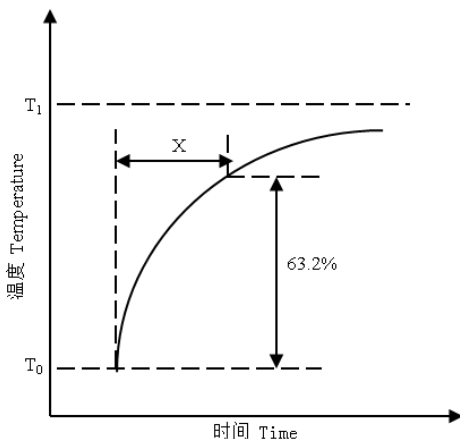
序号 No.	项目 Items	测试方法及备注 Test Methods and Remarks
1	25℃零功率电阻值 Nominal Zero-Power Resistance at 25℃(R25)	环境温度 Ambient temperature: 25±0.05℃ 测试功率 Measuring electric power: ≤0.1mW
2	B 值常数 Nominal B Constant	分别在环境温度 25±0.05℃, 50±0.05℃或 85±0.05℃下测量电阻值。 Measure the resistance at the ambient temperature of 25±0.05℃, 50±0.05℃ or 85±0.05℃. $B(25-50^{\circ}\text{C}) = \frac{\ln R_{25} - \ln R_{50}}{1/T_{25} - 1/T_{50}} \quad B(25-85^{\circ}\text{C}) = \frac{\ln R_{25} - \ln R_{85}}{1/T_{25} - 1/T_{85}}$ T: 绝对温度 (K) Absolute temperature (K)
3	热时间常数 Thermal Time Constant	<p>在零功率条件下，当热敏电阻的环境温度发生急剧变化时，热敏电阻元件产生最初温度 T₀ 与最终温度 T₁ 两者温度差的 63.2% 的温度变化所需要的时间，通常以秒(S)表示。</p> <p>The total time for the temperature of the thermistor to change by 63.2% of the difference from ambient temperature T₀ (°C) to T₁ (°C) by the drastic change of the power applied to thermistor from Non-zero Power to Zero-Power state, normally expressed in second(S).</p> 

4	耗散系数 Dissipation Factor	在一定环境温度下，NTC 热敏电阻通过自身发热使其温度升高 1℃ 时所需要的功率，通常以 mW/℃ 表示。可由下面公式计算： The required power which makes the NTC thermistor body temperature raise 1℃ through self-heated, normally expressed in milliwatts per degree Celsius (mW/℃). It can be calculated by the following formula: $\delta = \frac{W}{T-T_0}$
5	额定功率 Rated Power	在环境温度 25℃ 下因自身发热使表面温度升高 100℃ 所需要的功率。 The necessary electric power makes thermistor's temperature rise 100℃ by self-heating at ambient temperature 25℃.
6	允许工作电流 Permissible operating current	在静止空气中通过自身发热使其升温为 1℃ 的电流。 The current that keep body temperature of chip NTC on the PC board in still air rising 1℃ by self-heating.

信赖性试验 Reliability Test

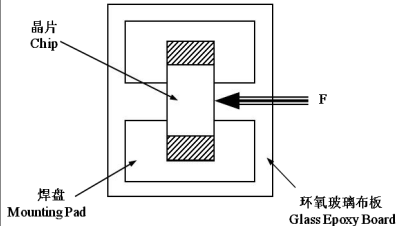
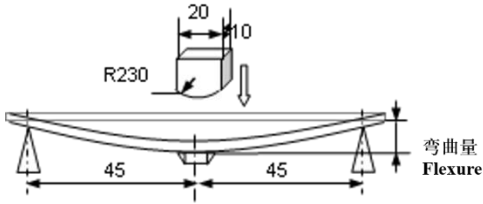
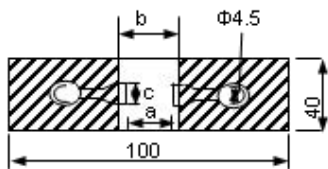
项目 Items	测试标准 Standard	测试方法及备注 Test Methods and Remarks	要求 Requirements																														
端头附着力 Terminal Strength	IEC 60068-2-21	<p>将晶片焊接在测试基板上（如右图所示的环氧玻璃布板），按箭头所示方向施加作用力； Solder the chip to the testing jig (glass epoxy board shown in the right) using eutectic solder. Then apply a force in the direction of the arrow.</p> <table border="1"> <thead> <tr> <th>尺寸 Size</th> <th>F</th> <th>保持时间 Duration</th> </tr> </thead> <tbody> <tr> <td>0201, 0402, 0603</td> <td>5N</td> <td rowspan="2">10±1s</td> </tr> <tr> <td>0805</td> <td>10N</td> </tr> </tbody> </table>	尺寸 Size	F	保持时间 Duration	0201, 0402, 0603	5N	10±1s	0805	10N	<p>端电极无脱落且瓷体无损伤。 No removal or split of the termination or other defects shall occur.</p> 																						
尺寸 Size	F	保持时间 Duration																															
0201, 0402, 0603	5N	10±1s																															
0805	10N																																
抗弯强度 Resistance to Flexure	IEC 60068-2-21	<p>将晶片焊接在测试基板上（如右图所示的环氧玻璃布板），按下图箭头所示方向施加作用力； Solder the chip to the test jig (glass epoxy board shown in the right) using a eutectic solder. Then apply a force in the direction shown as follow;</p>  <table border="1"> <thead> <tr> <th>尺寸 Size</th> <th>弯曲变形量 Flexure</th> <th>施压速度 Pressurizing Speed</th> <th>保持时间 Duration</th> </tr> </thead> <tbody> <tr> <td>0201,</td> <td>1mm</td> <td rowspan="2"><0.5mm/s</td> <td rowspan="2">10±1s</td> </tr> <tr> <td>0402, 0603, 0805</td> <td>2mm</td> </tr> </tbody> </table>	尺寸 Size	弯曲变形量 Flexure	施压速度 Pressurizing Speed	保持时间 Duration	0201,	1mm	<0.5mm/s	10±1s	0402, 0603, 0805	2mm	<p>① 无外观损伤。 No visible damage. ② $\Delta R_{25}/R_{25} \leq 5\%$</p> <p>单位 unit: mm</p> <table border="1"> <thead> <tr> <th>类型 Type</th> <th>a</th> <th>b</th> <th>c</th> </tr> </thead> <tbody> <tr> <td>0201</td> <td>0.25</td> <td>0.3</td> <td>0.3</td> </tr> <tr> <td>0402</td> <td>0.4</td> <td>1.5</td> <td>0.5</td> </tr> <tr> <td>0603</td> <td>1.0</td> <td>3.0</td> <td>1.2</td> </tr> <tr> <td>0805</td> <td>1.2</td> <td>4.0</td> <td>1.65</td> </tr> </tbody> </table> 	类型 Type	a	b	c	0201	0.25	0.3	0.3	0402	0.4	1.5	0.5	0603	1.0	3.0	1.2	0805	1.2	4.0	1.65
尺寸 Size	弯曲变形量 Flexure	施压速度 Pressurizing Speed	保持时间 Duration																														
0201,	1mm	<0.5mm/s	10±1s																														
0402, 0603, 0805	2mm																																
类型 Type	a	b	c																														
0201	0.25	0.3	0.3																														
0402	0.4	1.5	0.5																														
0603	1.0	3.0	1.2																														
0805	1.2	4.0	1.65																														

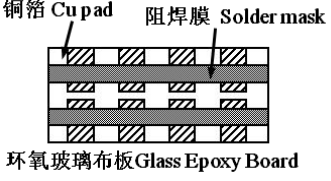
<p>振动 Vibration</p>	<p>IEC 60068-2-80</p>	<p>① 将晶片焊接在测试基板上（如右图所示的环氧玻璃布板）； Solder the chip to the testing jig (glass epoxy board shown in the left) using eutectic solder.</p> <p>② 晶片以全振幅为 1.5mm 进行振动，频率范围为 10Hz ~55 Hz； The chip shall be subjected to a simple harmonic motion having total amplitude of 1.5mm, the frequency being varied uniformly between the approximate limits of 10 and 55 Hz.</p> <p>③ 振动频率按 10Hz→55Hz→10Hz 循环，周期为 1 分钟，在空间三个互相垂直的方向上各振动 2 小时（共 6 小时）。 The frequency ranges from 10 to 55 Hz and return to 10 Hz shall be traversed in approximately 1 minute. This motion shall be applied for a period of 2 hours in each 3 mutually perpendicular directions (total of 6 hours).</p>	<p>无外观损伤。 No visible damage.</p> 															
<p>坠落 Dropping</p>	<p>IEC 60068-2-32</p>	<p>从 1m 的高度让晶片自由坠落至水泥地面 10 次。 Drop a chip 10 times on a concrete floor from a height of 1 meter.</p>	<p>无外观损伤。 No visible damage.</p>															
<p>可焊性 Solderability</p>	<p>IEC 60068-2-58</p>	<p>① 焊接温度 Solder temperature: 245±5℃. ② 浸渍时间 Duration: 3±0.3s. ③ 焊锡成分 Solder: Sn/3.0Ag/0.5Cu. ④ 助焊剂 Flux: （重量比）25%松香和 75%酒精 25% Resin and 75% ethanol in weight.</p>	<p>① 无外观损伤； No visible damage. ② 元件端电极的焊锡覆盖率不小于 95%。 Wetting shall exceed 95% coverage.</p>															
<p>耐焊性 Resistance to Soldering Heat</p>	<p>IEC 60068-2-58</p>	<p>① 焊接温度 Solder temperature: 260±5℃. ② 浸渍时间 Duration: 10±1s. ③ 焊锡成分 Solder: Sn/3.0Ag/0.5Cu. ④ 助焊剂 Flux: （重量比）25%松香和 75%酒精 25% Resin and 75% ethanol in weight. ⑤ 试验后标准条件下放置 1~2 小时后测量。 The chip shall be stabilized at normal condition for 1~2 hours before measuring.</p>	<p>① 无外观损伤； No visible damage. ② $\Delta R_{25}/R_{25} \leq 5\%$ ③ $\Delta B/B \leq 2\%$</p>															
<p>温度周期 Temperature cycling</p>	<p>IEC 60068-2-14</p>	<p>① 无负载于下表所示的环境条件下重复 5 次。 5 cycles of following sequence without loading.</p> <table border="1" data-bbox="491 1429 1040 1624"> <thead> <tr> <th>步骤 Step</th> <th>温度 Temperature</th> <th>时间 Time</th> </tr> </thead> <tbody> <tr> <td>1</td> <td>-40±5℃</td> <td>30±3min</td> </tr> <tr> <td>2</td> <td>25±2℃</td> <td>5±3min</td> </tr> <tr> <td>3</td> <td>125±2℃</td> <td>30±3min</td> </tr> <tr> <td>4</td> <td>25±2℃</td> <td>5±3min</td> </tr> </tbody> </table> <p>② 试验后标准条件下放置 1~2 小时后测量。 The chip shall be stabilized at normal condition for 1~2 hours before measuring.</p>	步骤 Step	温度 Temperature	时间 Time	1	-40±5℃	30±3min	2	25±2℃	5±3min	3	125±2℃	30±3min	4	25±2℃	5±3min	<p>① 无外观损伤； No visible damage. ② $\Delta R_{25}/R_{25} \leq 3\%$ ③ $\Delta B/B \leq 2\%$</p>
步骤 Step	温度 Temperature	时间 Time																
1	-40±5℃	30±3min																
2	25±2℃	5±3min																
3	125±2℃	30±3min																
4	25±2℃	5±3min																
<p>高温存放 Resistance to dry heat</p>	<p>IEC 60068-2-2</p>	<p>① 在 125±5℃ 空气中，无负载放置 1000±24 小时。 125±5℃ in air, for 1000±24 hours without loading. ② 试验后标准条件下放置 1~2 小时后测量。 The chip shall be stabilized at normal condition for 1~2 hours before measuring.</p>	<p>① 无外观损伤； No visible damage. ② $\Delta R_{25}/R_{25} \leq 5\%$ ③ $\Delta B/B \leq 2\%$</p>															

低温存放 Resistance to cold	IEC 60068-2-1	① 在-40±3℃空气中，无负载放置 1000±24 小时。 -40±3℃ in air, for 1000±24 hours without loading. ② 试验后标准条件下放置 1~2 小时后测量。 The chip shall be stabilized at normal condition for 1~2 hours before measuring.	① 无外观损伤； No visible damage. ② $ \Delta R25/R25 \leq 5\%$ ③ $ \Delta B/B \leq 2\%$
湿热存放 Resistance to damp heat	IEC 60068-2-78	① 在 40±2℃，相对湿度 90~95%空气中，无负载放置 1000±24 小时。 40±2℃, 90~95%RH in air, for 1000±24 hours without loading. ② 试验后标准条件下放置 1~2 小时后测量。 The chip shall be stabilized at normal condition for 1~2 hours before measuring.	① 无外观损伤； No visible damage. ② $ \Delta R25/R25 \leq 3\%$ ③ $ \Delta B/B \leq 2\%$
高温负荷 Resistance to high temperature load	IEC 60539-1 5.25.4	① 在 85±2℃空气中，施加允许工作电流 1000±48 小时。 85±2℃ in air with permissive operating current for 1000±48 hours ② 试验后标准条件下放置 1~2 小时后测量。 The chip shall be stabilized at normal condition for 1~2 hours before measuring.	① 无外观损伤； No visible damage. ② $ \Delta R25/R25 \leq 5\%$ ③ $ \Delta B/B \leq 2\%$

编带 Taping

类型 Type	0201	0402	0603	0805
编带厚度 Tape thickness(mm)	0.5±0.15	0.5±0.15	0.8±0.15	0.85±0.2
编带材质 Tape material	纸带 Paper Tape			
每盘数量 Quantity per Reel	15K	10K	4K	4K

(1) 编带图 Taping Drawings

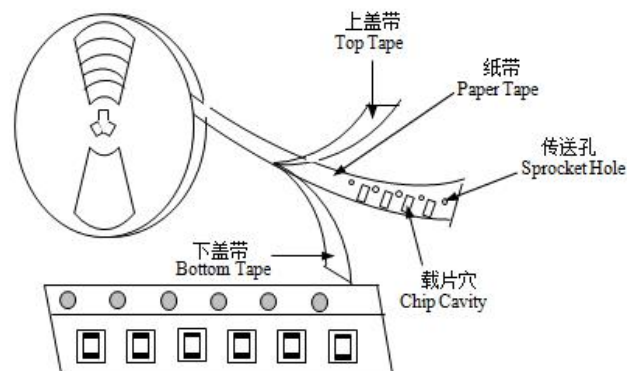

(2) 纸带尺寸 Paper Tape Dimensions

(单位 Unit: mm)

0201 系列

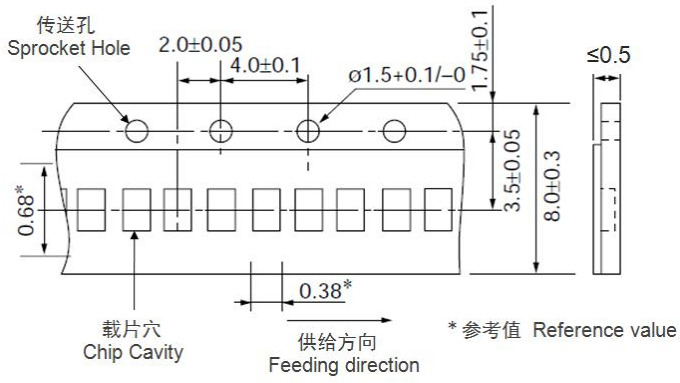

0402 系列

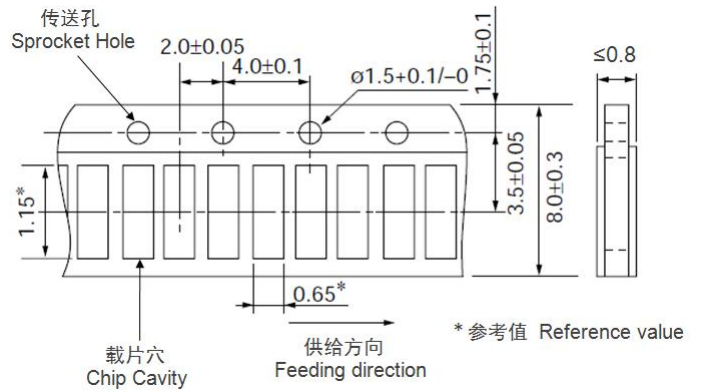

0603 系列

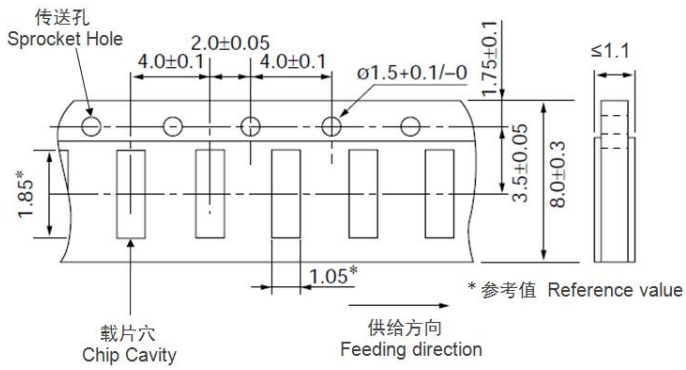

0805 系列

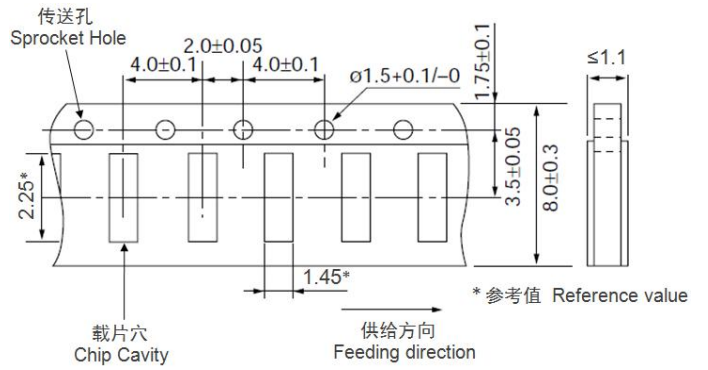

(3) 卷盘尺寸 Reel Dimensions (单位 Unit: mm)

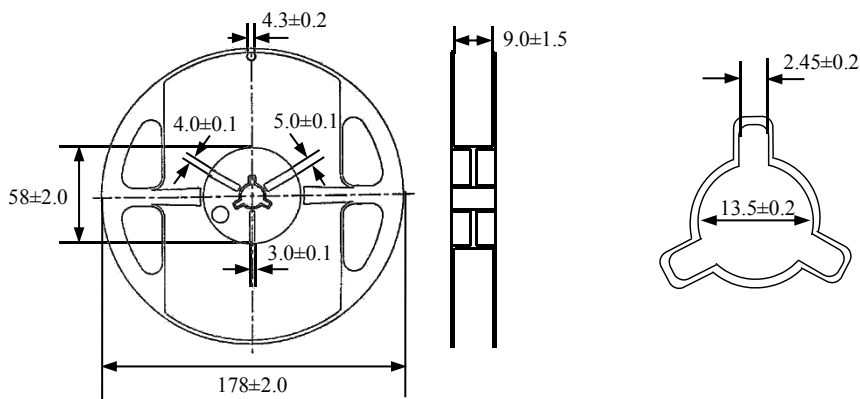

储存

- **储存条件**
 - a. 储存温度: $-10^{\circ}\text{C} \sim 40^{\circ}\text{C}$
 - b. 相对湿度: $\leq 75\% \text{RH}$
 - c. 避免接触粉尘、腐蚀性气氛和阳光
- **储存期限: 产品交付后 6 个月**

注意事项

- 热敏电阻不可在以下条件下工作或储存:
 - (1) 腐蚀性气体或还原性气体
(氯气、硫化氢气体、氨气、硫酸气体、一氧化氮等)。
 - (2) 挥发性或易燃性气体
 - (3) 多尘条件
 - (4) 高压或低压条件
 - (5) 潮湿场所
 - (6) 存在盐水、油、化学液体或有机溶剂的场所
 - (7) 强烈振动
 - (8) 存在类似有害条件的其他场所
- 热敏电阻的陶瓷属于易碎材料, 使用时不可施加过大压力或冲击。
- 热敏电阻不可在超过目录规定的温度范围情况下工作。

Storage

- **Storage Conditions**
 - a. Storage Temperature: $-10^{\circ}\text{C} \sim 40^{\circ}\text{C}$
 - b. Relative Humidity: $\cong 75\% \text{RH}$
 - c. Keep away from corrosive atmosphere and sunlight.
- **Period of Storage: 6 Months after delivery**

Notes & Warnings

- The thermistors shall not be operated and stored under the following environmental condition:
 - (1) Corrosive or deoxidized atmospheres
(such as chlorine, sulfurated hydrogen, ammonia, sulfuric acid, nitric oxide and so on)
 - (2) Volatile or inflammable atmospheres
 - (3) Dusty condition
 - (4) Excessively high or low pressure condition
 - (5) Humid site
 - (6) Places with brine, oil, chemical liquid or organic solvent
 - (7) Intense vibration
 - (8) Places with analogously deleterious conditions
- The ceramic body of the thermistors is fragile, no excessive pressure or impact shall be exerted on it.
- The thermistors shall not be operated beyond the specified "Operating Temperature Range" in the catalog.

建议焊接条件

• **回流焊**

- 温升 1~2°C/sec.
- 预热：150~170°C/90±30 sec.
- 大于 240°C时间：20~40sec
- 峰值温度：最高 260°C/10 sec.
- 焊锡：96.5Sn/3.0Ag/0.5Cu
- 回流焊：最多 2 次

10 Recommended Soldering Technologies

• **Re-flowing Profile**

- 1~2°C/sec. Ramp
- Pre-heating: 150~170°C/90±30 sec.
- Time above 240°C: 20~40 sec.
- Peak temperature: 260°C Max./10 sec.
- Solder paste: 96.5Sn/3.0Ag/0.5Cu
- Max.2 times for re-flowing

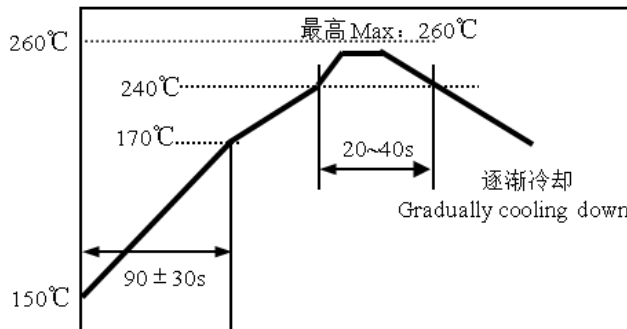

• **手工焊**

- 烙铁功率：最大 20W
- 预热：150°C/60sec.
- 烙铁头温度：最高 280°C
- 焊接时间：最多 3sec.
- 焊锡：96.5Sn/3.0Ag/0.5Cu
- 手工焊：最多 1 次

• **Iron Soldering Profile**

- Iron soldering power: Max.20W
- Pre-heating: 150°C/60sec.
- Soldering Tip temperature: 280°C Max.
- Soldering time: 3 sec Max.
- Solder paste: 96.5Sn/3.0Ag/0.5Cu
- Max.1 times for iron soldering

[注：不要使烙铁头接触到端头]

[Note: Take care not to apply the tip of the soldering iron to the terminal electrodes.]

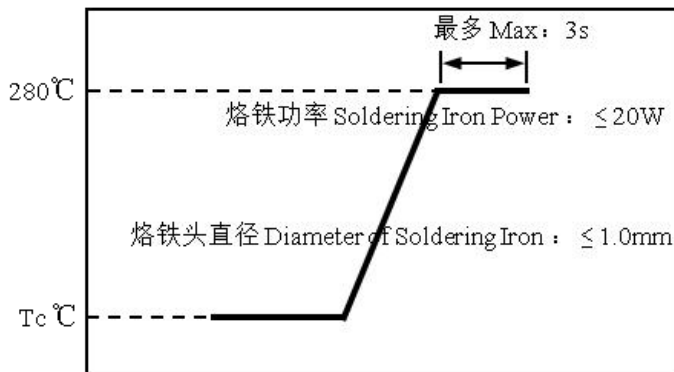

R-T 表 R-T table

温度 Temp. (°C)	R 最小值 R_Min (Kohm)	R 中心值 R_Cent (Kohm)	R 最大值 R_Max (Kohm)	阻值公差 Res TOL.	温度公差 Temp. TOL.(°C)
-40	329.927	345.275	361.300	4.64%	0.67
-39	308.651	322.791	337.545	4.57%	0.66
-38	288.892	301.925	315.514	4.50%	0.66
-37	270.532	282.549	295.071	4.43%	0.65
-36	253.464	264.549	276.091	4.36%	0.65
-35	237.587	247.816	258.459	4.29%	0.64
-34	222.812	232.254	242.072	4.23%	0.64
-33	209.055	217.774	226.833	4.16%	0.63
-32	196.239	204.292	212.655	4.09%	0.63
-31	184.293	191.735	199.457	4.03%	0.62
-30	173.153	180.032	187.165	3.96%	0.61
-29	162.760	169.120	175.711	3.90%	0.61
-28	153.059	158.941	165.033	3.83%	0.60
-27	144.000	149.441	155.073	3.77%	0.60
-26	135.535	140.571	145.779	3.71%	0.59
-25	127.622	132.284	137.102	3.64%	0.59
-24	120.207	124.522	128.979	3.58%	0.58
-23	113.270	117.266	121.391	3.52%	0.58
-22	106.779	110.480	114.298	3.46%	0.57
-21	100.701	104.130	107.664	3.39%	0.56
-20	95.008	98.185	101.459	3.33%	0.56
-19	89.674	92.618	95.650	3.27%	0.55
-18	84.672	87.402	90.211	3.21%	0.55
-17	79.982	82.513	85.115	3.15%	0.54
-16	75.580	77.927	80.339	3.10%	0.53
-15	71.449	73.626	75.861	3.04%	0.53
-14	67.569	69.588	71.661	2.98%	0.52
-13	63.924	65.797	67.719	2.92%	0.51
-12	60.498	62.237	64.019	2.86%	0.51
-11	57.277	58.890	60.543	2.81%	0.50
-10	54.247	55.744	57.278	2.75%	0.49
-9	51.396	52.786	54.208	2.69%	0.49
-8	48.712	50.002	51.322	2.64%	0.48
-7	46.184	47.382	48.606	2.58%	0.47
-6	43.803	44.916	46.051	2.53%	0.47
-5	41.559	42.592	43.646	2.47%	0.46
-4	39.441	40.400	41.377	2.42%	0.45
-3	37.443	38.333	39.240	2.37%	0.45
-2	35.559	36.385	37.227	2.31%	0.44
-1	33.781	34.548	35.328	2.26%	0.43
0	32.102	32.814	33.538	2.21%	0.43
1	30.518	31.179	31.851	2.16%	0.42

温度 Temp. (°C)	R 最小值 R_Min (Kohm)	R 中心值 R_Cent (Kohm)	R 最大值 R_Max (Kohm)	阻值公差 Res TOL.	温度公差 Temp. TOL.(°C)
2	29.022	29.636	30.259	2.10%	0.41
3	27.608	28.178	28.756	2.05%	0.40
4	26.271	26.800	27.336	2.00%	0.40
5	25.007	25.497	25.994	1.95%	0.39
6	23.808	24.263	24.724	1.90%	0.38
7	22.674	23.096	23.523	1.85%	0.37
8	21.601	21.992	22.387	1.80%	0.37
9	20.584	20.947	21.313	1.75%	0.36
10	19.622	19.958	20.297	1.70%	0.35
11	18.711	19.022	19.336	1.65%	0.34
12	17.847	18.135	18.425	1.60%	0.33
13	17.028	17.294	17.563	1.55%	0.33
14	16.251	16.498	16.746	1.51%	0.32
15	15.514	15.742	15.972	1.46%	0.31
16	14.814	15.025	15.237	1.41%	0.30
17	14.150	14.345	14.541	1.37%	0.29
18	13.519	13.699	13.880	1.32%	0.29
19	12.921	13.086	13.253	1.27%	0.28
20	12.351	12.504	12.657	1.23%	0.27
21	11.811	11.951	12.092	1.18%	0.26
22	11.296	11.426	11.555	1.13%	0.25
23	10.808	10.926	11.045	1.09%	0.24
24	10.342	10.452	10.561	1.04%	0.24
25	9.900	10.000	10.100	1.00%	0.23
26	9.471	9.570	9.670	1.04%	0.24
27	9.062	9.162	9.261	1.09%	0.25
28	8.673	8.773	8.872	1.13%	0.26
29	8.304	8.402	8.501	1.18%	0.27
30	7.952	8.049	8.147	1.22%	0.29
31	7.616	7.713	7.811	1.26%	0.30
32	7.297	7.393	7.490	1.31%	0.31
33	6.993	7.088	7.184	1.35%	0.32
34	6.703	6.797	6.892	1.39%	0.33
35	6.427	6.520	6.613	1.43%	0.35
36	6.164	6.255	6.348	1.47%	0.36
37	5.913	6.003	6.094	1.52%	0.37
38	5.673	5.762	5.852	1.56%	0.38
39	5.445	5.532	5.621	1.60%	0.40
40	5.226	5.313	5.400	1.64%	0.41
41	5.018	5.103	5.189	1.68%	0.42
42	4.819	4.903	4.987	1.72%	0.43
43	4.629	4.711	4.795	1.76%	0.45
44	4.448	4.529	4.610	1.80%	0.46
45	4.274	4.354	4.434	1.84%	0.47

温度 Temp. (°C)	R 最小值 R_Min (Kohm)	R 中心值 R_Cent (Kohm)	R 最大值 R_Max (Kohm)	阻值公差 Res TOL.	温度公差 Temp. TOL.(°C)
46	4.109	4.187	4.266	1.88%	0.49
47	3.951	4.027	4.104	1.92%	0.50
48	3.799	3.874	3.950	1.96%	0.51
49	3.655	3.728	3.803	2.00%	0.53
50	3.516	3.588	3.661	2.04%	0.54
51	3.384	3.454	3.526	2.08%	0.55
52	3.257	3.326	3.396	2.12%	0.57
53	3.135	3.203	3.272	2.16%	0.58
54	3.019	3.086	3.153	2.19%	0.59
55	2.908	2.973	3.039	2.23%	0.61
56	2.801	2.865	2.930	2.27%	0.62
57	2.699	2.761	2.825	2.31%	0.64
58	2.601	2.662	2.724	2.35%	0.65
59	2.507	2.567	2.628	2.38%	0.66
60	2.417	2.476	2.535	2.42%	0.68
61	2.331	2.388	2.447	2.46%	0.69
62	2.248	2.304	2.362	2.49%	0.71
63	2.169	2.224	2.280	2.53%	0.72
64	2.092	2.146	2.201	2.57%	0.74
65	2.019	2.072	2.126	2.60%	0.75
66	1.949	2.001	2.053	2.64%	0.76
67	1.882	1.932	1.984	2.67%	0.78
68	1.817	1.866	1.917	2.71%	0.79
69	1.754	1.803	1.852	2.75%	0.81
70	1.695	1.742	1.790	2.78%	0.82
71	1.637	1.684	1.731	2.82%	0.84
72	1.582	1.628	1.674	2.85%	0.85
73	1.529	1.574	1.619	2.88%	0.87
74	1.479	1.522	1.566	2.92%	0.88
75	1.430	1.472	1.516	2.95%	0.90
76	1.383	1.424	1.467	2.99%	0.92
77	1.337	1.378	1.419	3.02%	0.93
78	1.294	1.333	1.374	3.06%	0.95
79	1.251	1.290	1.330	3.09%	0.96
80	1.211	1.249	1.288	3.12%	0.98
81	1.172	1.209	1.247	3.16%	0.99
82	1.135	1.171	1.208	3.19%	1.01
83	1.099	1.134	1.171	3.22%	1.03
84	1.064	1.099	1.135	3.26%	1.04
85	1.031	1.065	1.100	3.29%	1.06
86	0.998	1.032	1.066	3.32%	1.07
87	0.967	1.000	1.033	3.35%	1.09
88	0.937	0.969	1.002	3.38%	1.11
89	0.908	0.940	0.972	3.42%	1.12

温度 Temp. (°C)	R 最小值 R_Min (Kohm)	R 中心值 R_Cent (Kohm)	R 最大值 R_Max (Kohm)	阻值公差 Res TOL.	温度公差 Temp. TOL.(°C)
90	0.881	0.911	0.943	3.45%	1.14
91	0.854	0.884	0.914	3.48%	1.16
92	0.828	0.857	0.887	3.51%	1.17
93	0.803	0.831	0.861	3.54%	1.19
94	0.779	0.807	0.835	3.57%	1.21
95	0.755	0.783	0.811	3.61%	1.22
96	0.733	0.760	0.787	3.64%	1.24
97	0.711	0.738	0.765	3.67%	1.26
98	0.691	0.716	0.743	3.70%	1.27
99	0.670	0.695	0.721	3.73%	1.29
100	0.651	0.675	0.701	3.76%	1.31
101	0.632	0.656	0.681	3.79%	1.33
102	0.614	0.637	0.662	3.82%	1.34
103	0.596	0.619	0.643	3.85%	1.36
104	0.579	0.602	0.625	3.88%	1.38
105	0.563	0.585	0.608	3.91%	1.40
106	0.547	0.569	0.591	3.94%	1.41
107	0.532	0.553	0.575	3.97%	1.43
108	0.517	0.538	0.559	4.00%	1.45
109	0.502	0.523	0.544	4.03%	1.47
110	0.489	0.508	0.529	4.05%	1.49
111	0.475	0.495	0.515	4.08%	1.50
112	0.462	0.481	0.501	4.11%	1.52
113	0.449	0.468	0.487	4.14%	1.54
114	0.437	0.456	0.474	4.17%	1.56
115	0.425	0.443	0.462	4.20%	1.58
116	0.414	0.432	0.450	4.22%	1.60
117	0.403	0.420	0.438	4.25%	1.62
118	0.392	0.409	0.427	4.28%	1.63
119	0.382	0.399	0.416	4.31%	1.65
120	0.372	0.388	0.405	4.34%	1.67
121	0.362	0.378	0.395	4.36%	1.69
122	0.353	0.368	0.385	4.39%	1.71
123	0.344	0.359	0.375	4.42%	1.73
124	0.335	0.350	0.365	4.44%	1.75
125	0.326	0.341	0.356	4.47%	1.77