

IR Receiver Modules for Remote Control Systems



16672

DESIGN SUPPORT TOOLS

[click logo to get started](#)


MECHANICAL DATA

Pinning for TSOP44..., TSOP48...:

 1 = OUT, 2 = GND, 3 = V_S

Pinning for TSOP22..., TSOP24...:

 1 = OUT, 2 = V_S , 3 = GND

FEATURES

- Improved immunity against HF and RF noise
- Low supply current
- Photo detector and preamplifier in one package
- Internal filter for PCM frequency
- Supply voltage: 2.5 V to 5.5 V
- Improved immunity against optical noise
- Insensitive to supply voltage ripple and noise
- Material categorization:
for definitions of compliance please see www.vishay.com/doc?99912



DESCRIPTION

The TSOP22..., TSOP48..., TSOP24.. and TSOP44.. series are miniaturized IR receiver modules for infrared remote control systems. A PIN diode and a preamplifier are assembled on lead frame, the epoxy package contains an IR filter.

The demodulated output signal can be directly connected to a microprocessor for decoding.

The TSOP24..., TSOP44.. series devices are optimized to suppress almost all spurious pulses from Wi-Fi and CFL sources. They may suppress some data signals if continuously transmitted.

The TSOP22..., TSOP48.. series devices are provided primarily for compatibility with old AGC2 designs. New designs should prefer the TSOP24..., TSOP44.. series containing the newer AGC4.

These components have not been qualified according to automotive specifications.

PARTS TABLE					
AGC		LEGACY, FOR LONG BURST REMOTE CONTROLS (AGC2)		RECOMMENDED FOR LONG BURST CODES (AGC4)	
Carrier frequency	30 kHz	TSOP4830	TSOP2230	TSOP4430	TSOP2430
	33 kHz	TSOP4833	TSOP2233	TSOP4433	TSOP2433
	36 kHz	TSOP4836	TSOP2236	TSOP4436 ⁽¹⁾⁽²⁾⁽³⁾	TSOP2436 ⁽¹⁾⁽²⁾⁽³⁾
	38 kHz	TSOP4838	TSOP2238	TSOP4438 ⁽⁴⁾⁽⁵⁾⁽⁶⁾	TSOP2438 ⁽⁴⁾⁽⁵⁾⁽⁶⁾
	40 kHz	TSOP4840	TSOP2240	TSOP4440	TSOP2440
	56 kHz	TSOP4856	TSOP2256	TSOP4456 ⁽⁶⁾⁽⁷⁾	TSOP2456 ⁽⁶⁾⁽⁷⁾
Package		Mold			
Pinning		1 = OUT, 2 = GND, 3 = V_S	1 = OUT, 2 = V_S , 3 = GND	1 = OUT, 2 = GND, 3 = V_S	1 = OUT, 2 = V_S , 3 = GND
Dimensions (mm)		6.0 W x 6.95 H x 5.6 D			
Mounting		Leaded			
Application		Remote control			
Best choice for		⁽¹⁾ RC-5 ⁽²⁾ RC-6 ⁽³⁾ Panasonic ⁽⁴⁾ NEC ⁽⁵⁾ Sharp ⁽⁶⁾ r-step ⁽⁷⁾ Thomson RCA			

BLOCK DIAGRAM

APPLICATION CIRCUIT

ABSOLUTE MAXIMUM RATINGS

PARAMETER	TEST CONDITION	SYMBOL	VALUE	UNIT
Supply voltage		V_S	-0.3 to +6	V
Supply current		I_S	5	mA
Output voltage		V_O	-0.3 to 5.5	V
Voltage at output to supply		$V_S - V_O$	-0.3 to $(V_S + 0.3)$	V
Output current		I_O	5	mA
Junction temperature		T_j	100	°C
Storage temperature range		T_{stg}	-25 to +85	°C
Operating temperature range		T_{amb}	-25 to +85	°C
Power consumption	$T_{amb} \leq 85\text{ °C}$	P_{tot}	10	mW
Soldering temperature	$t \leq 10\text{ s}$, 1 mm from case	T_{sd}	260	°C

Note

- Stresses beyond those listed under “Absolute Maximum Ratings” may cause permanent damage to the device. This is a stress rating only and functional operation of the device at these or any other conditions beyond those indicated in the operational sections of this specification is not implied. Exposure to absolute maximum rating conditions for extended periods may affect the device reliability

ELECTRICAL AND OPTICAL CHARACTERISTICS ($T_{amb} = 25\text{ °C}$, unless otherwise specified)

PARAMETER	TEST CONDITION	SYMBOL	MIN.	TYP.	MAX.	UNIT
Supply current	$E_v = 0, V_S = 5\text{ V}$	I_{SD}	0.55	0.7	0.9	mA
	$E_v = 40\text{ klx}$, sunlight	I_{SH}	-	0.8	-	mA
Supply voltage		V_S	2.5	-	5.5	V
Transmission distance	$E_v = 0$, test signal see Fig. 1, IR diode TSAL6200, $I_F = 200\text{ mA}$	d	-	45	-	m
Output voltage low	$I_{OSL} = 0.5\text{ mA}$, $E_e = 0.7\text{ mW/m}^2$, test signal see Fig. 1	V_{OSL}	-	-	100	mV
Minimum irradiance	Pulse width tolerance: $t_{pi} - 5/f_o < t_{po} < t_{pi} + 6/f_o$, test signal see Fig. 1	$E_e\text{ min.}$	-	0.12	0.25	mW/m^2
Maximum irradiance	$t_{pi} - 5/f_o < t_{po} < t_{pi} + 6/f_o$, test signal see Fig. 1	$E_e\text{ max.}$	50	-	-	W/m^2
Directivity	Angle of half transmission distance	$\phi_{1/2}$	-	± 45	-	deg

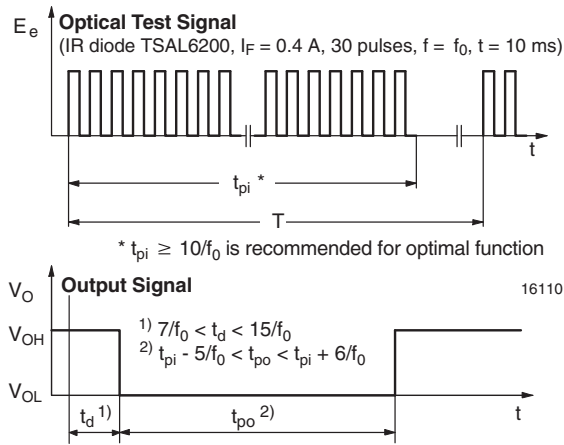
TYPICAL CHARACTERISTICS ($T_{amb} = 25\text{ }^{\circ}\text{C}$, unless otherwise specified)


Fig. 1 - Output Active Low

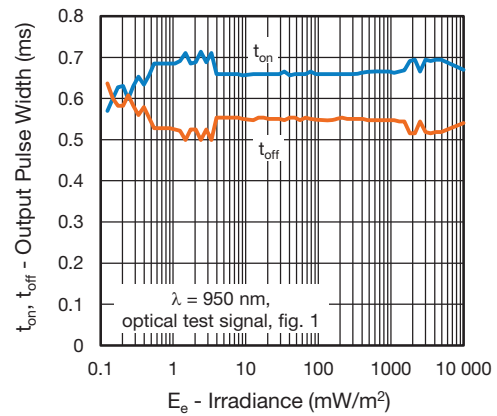


Fig. 4 - Output Pulse Diagram

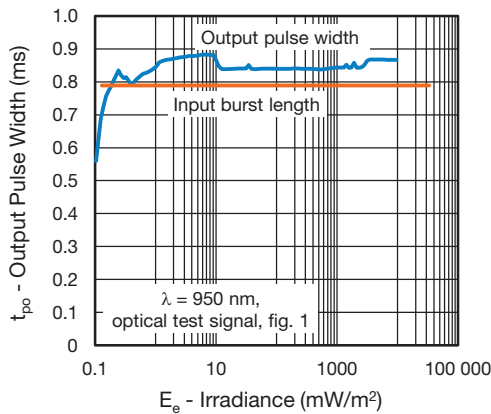


Fig. 2 - Pulse Length and Sensitivity in Dark Ambient

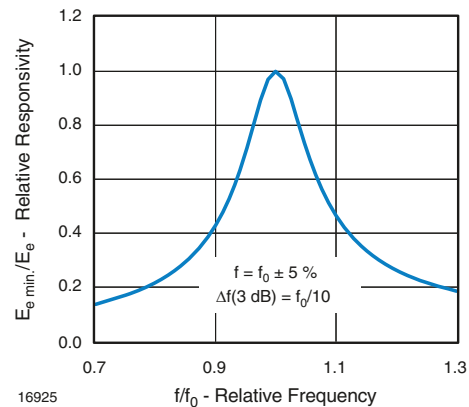


Fig. 5 - Frequency Dependence of Responsivity

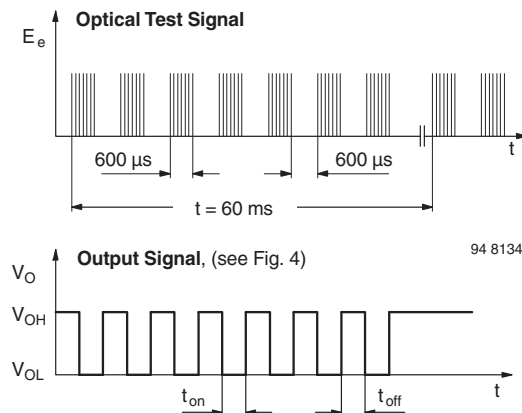


Fig. 3 - Output Function

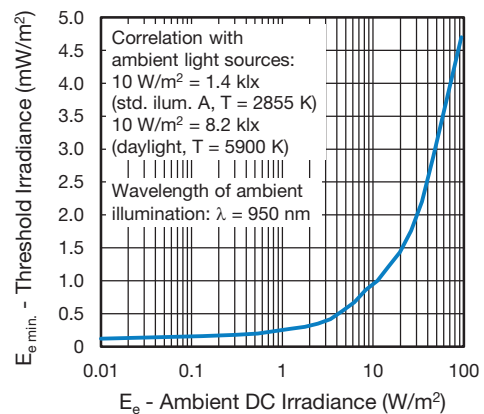


Fig. 6 - Sensitivity in Bright Ambient

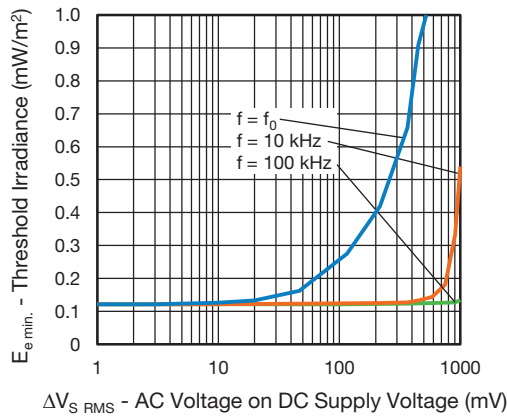


Fig. 7 - Sensitivity vs. Supply Voltage Disturbances

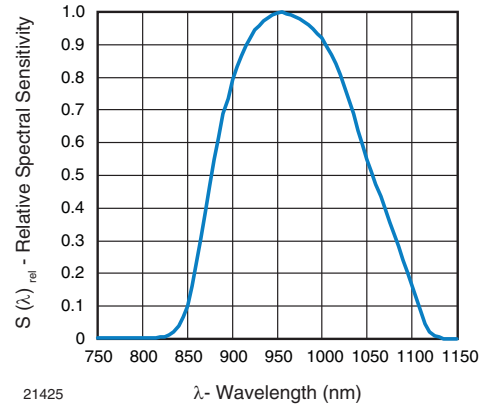


Fig. 10 - Relative Spectral Sensitivity vs. Wavelength

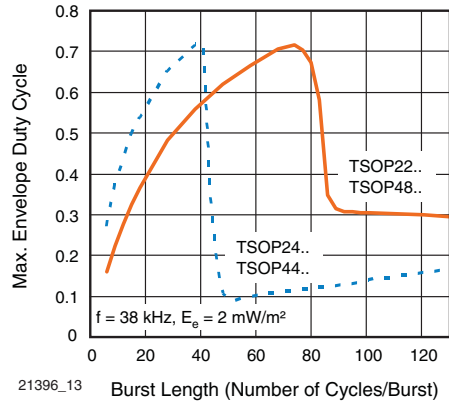


Fig. 8 - Max. Envelope Duty Cycle vs. Burst Length

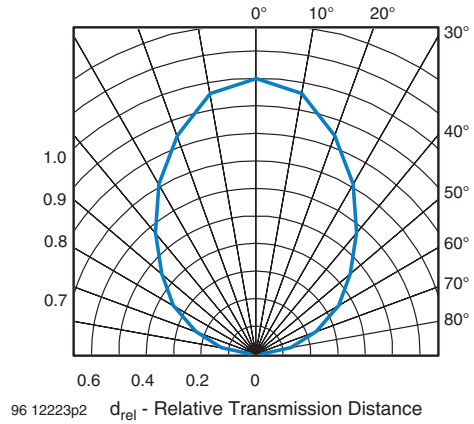


Fig. 11 - Horizontal Directivity

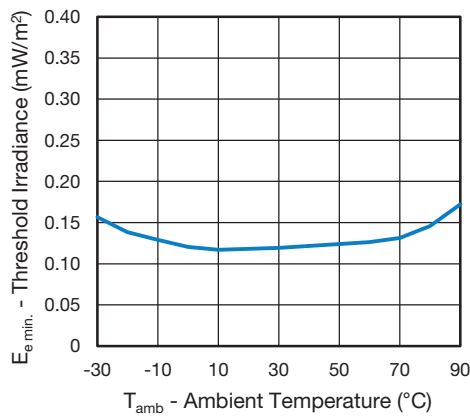


Fig. 9 - Sensitivity vs. Ambient Temperature

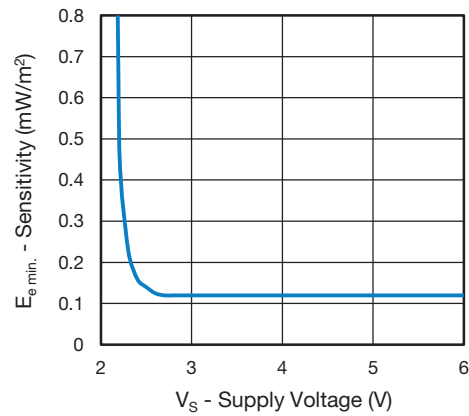


Fig. 12 - Sensitivity vs. Supply Voltage

SUITABLE DATA FORMAT

This series is designed to suppress spurious output pulses due to noise or disturbance signals. The devices can distinguish data signals from noise due to differences in frequency, burst length, and envelope duty cycle. The data signal should be close to the device's band-pass center frequency (e.g. 38 kHz) and fulfill the conditions in the table below.

When a data signal is applied to the product in the presence of a disturbance, the sensitivity of the receiver is automatically reduced by the AGC to insure that no spurious pulses are present at the receiver's output. Some examples which are suppressed are:

- DC light (e.g. from tungsten bulbs sunlight)
- Continuous signals at any frequency
- Strongly or weakly modulated patterns from fluorescent lamps with electronic ballasts (see Fig. 13 or Fig. 14).
- 2.4 GHz and 5 GHz Wi-Fi



Fig. 13 - IR Disturbance from Fluorescent Lamp With Low Modulation



Fig. 14 - IR Disturbance from Fluorescent Lamp With High Modulation

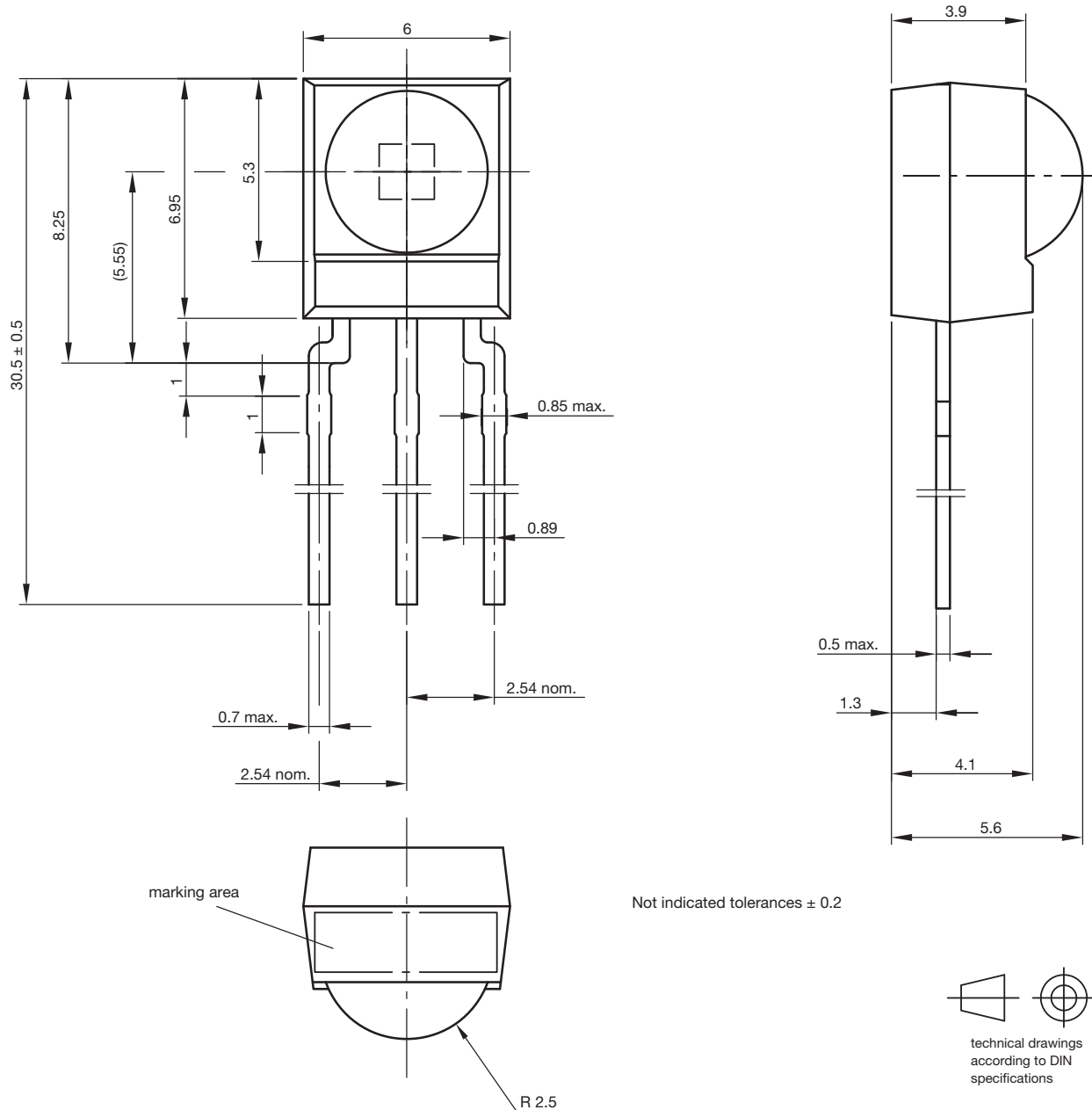
	TSOP22..., TSOP48..	TSOP24..., TSOP44..
Minimum burst length	10 cycles/burst	10 cycles/burst
After each burst of length a minimum gap time is required of	10 to 70 cycles ≥ 12 cycles	10 to 35 cycles ≥ 12 cycles
For bursts greater than a minimum gap time in the data stream is needed of	70 cycles > 4 x burst length	35 cycles > 10 x burst length
Maximum number of continuous short bursts/second	800	1300
NEC code	Yes	Preferred
RC5/RC6 code	Yes	Preferred
Thomson 56 kHz code	Yes	Preferred
Sharp code	Yes	Preferred
Suppression of interference from fluorescent lamps	Mild disturbance patterns are suppressed (example: signal pattern of Fig. 13)	Complex and critical disturbance patterns are suppressed (example: signal pattern of Fig. 14 or highly dimmed LCDs)

Note

- For data formats with short bursts please see the datasheet of TSOP23..., TSOP43..



PACKAGE DIMENSIONS in millimeters



Drawing-No.: 6.550-5169.01-4
Issue: 9; 03.11.10
13655



Disclaimer

ALL PRODUCT, PRODUCT SPECIFICATIONS AND DATA ARE SUBJECT TO CHANGE WITHOUT NOTICE TO IMPROVE RELIABILITY, FUNCTION OR DESIGN OR OTHERWISE.

Vishay Intertechnology, Inc., its affiliates, agents, and employees, and all persons acting on its or their behalf (collectively, "Vishay"), disclaim any and all liability for any errors, inaccuracies or incompleteness contained in any datasheet or in any other disclosure relating to any product.

Vishay makes no warranty, representation or guarantee regarding the suitability of the products for any particular purpose or the continuing production of any product. To the maximum extent permitted by applicable law, Vishay disclaims (i) any and all liability arising out of the application or use of any product, (ii) any and all liability, including without limitation special, consequential or incidental damages, and (iii) any and all implied warranties, including warranties of fitness for particular purpose, non-infringement and merchantability.

Statements regarding the suitability of products for certain types of applications are based on Vishay's knowledge of typical requirements that are often placed on Vishay products in generic applications. Such statements are not binding statements about the suitability of products for a particular application. It is the customer's responsibility to validate that a particular product with the properties described in the product specification is suitable for use in a particular application. Parameters provided in datasheets and / or specifications may vary in different applications and performance may vary over time. All operating parameters, including typical parameters, must be validated for each customer application by the customer's technical experts. Product specifications do not expand or otherwise modify Vishay's terms and conditions of purchase, including but not limited to the warranty expressed therein.

Except as expressly indicated in writing, Vishay products are not designed for use in medical, life-saving, or life-sustaining applications or for any other application in which the failure of the Vishay product could result in personal injury or death. Customers using or selling Vishay products not expressly indicated for use in such applications do so at their own risk. Please contact authorized Vishay personnel to obtain written terms and conditions regarding products designed for such applications.

No license, express or implied, by estoppel or otherwise, to any intellectual property rights is granted by this document or by any conduct of Vishay. Product names and markings noted herein may be trademarks of their respective owners.