

## Spartan-6 FPGA Electrical Characteristics

Spartan®-6 FPGAs are available in -3, -2, -1L speed grades, with -3 having the highest performance. Spartan-6 FPGA DC and AC characteristics are specified for both commercial and industrial grades. Except the operating temperature range or unless otherwise noted, all the DC and AC electrical parameters are the same for a particular speed grade (that is, the timing characteristics of a -2 speed grade industrial device are the same as for a -2 speed grade commercial device). However, only selected speed grades and/or devices might be available in the industrial range.

All supply voltage and junction temperature specifications are representative of worst-case conditions. The parameters included are common to popular designs and typical applications.

This Spartan-6 FPGA data sheet, part of an overall set of documentation on the Spartan-6 family of FPGAs, is available on the Xilinx website.

All specifications are subject to change without notice.

## Spartan-6 FPGA DC Characteristics

Table 1: Absolute Maximum Ratings

Symbol	Description		Units
$V_{CCINT}$	Internal supply voltage relative to GND	-0.5 to 1.32	V
$V_{CCAUX}$	Auxiliary supply voltage relative to GND	-0.5 to 3.75	V
$V_{CCO}$	Output drivers supply voltage relative to GND	-0.5 to 3.75	V
$V_{BATT}$	Key memory battery backup supply (XC6SLX75, XC6SLX75T, XC6SLX100, XC6SLX100T, XC6SLX150, and XC6SLX150T only)	-0.5 to 4.05	V
$V_{FS}$	External voltage supply for eFUSE programming (XC6SLX75, XC6SLX75T, XC6SLX100, XC6SLX100T, XC6SLX150, and XC6SLX150T only). <sup>(5)</sup>	-0.5 to 3.75	V
$V_{REF}$	Input reference voltage	-0.5 to 3.75	V
$V_{IN}^{(2)}$	I/O input voltage relative to GND <sup>(3)</sup> (user and dedicated I/Os)	-0.95 to 4.4	V
$V_{TS}$	Voltage applied to 3-state output (user and dedicated I/Os)	-0.95 to 4.4	V
$T_{STG}$	Storage temperature (ambient)	-65 to 150	°C
$T_{SOL}$	Maximum soldering temperature <sup>(4)</sup> (TQG144, CSG225, CSG324, and FTG256)	+260	°C
	Maximum soldering temperature <sup>(4)</sup> (Pb-free packages: FGG484 and FGG676)	+250	°C
	Maximum soldering temperature <sup>(4)</sup> (Pb packages: FT256, FG484, FG676)	+220	°C
$T_J$	Maximum junction temperature <sup>(4)</sup>	+125	°C

### Notes:

- Stresses beyond those listed under Absolute Maximum Ratings might cause permanent damage to the device. These are stress ratings only, and functional operation of the device at these or any other conditions beyond those listed under Operating Conditions is not implied. Exposure to Absolute Maximum Ratings conditions for extended periods of time might affect device reliability.
- I/O absolute maximum limit applied to DC and AC signals.
- For I/O operation, refer to the [Spartan-6 FPGA SelectIO Resources User Guide](#).
- For soldering guidelines and thermal considerations, see [Spartan-6 FPGA Packaging and Pinout Specification](#).
- When not programming eFUSE, connect  $V_{FS}$  to  $V_{CCAUX}$ .

Table 2: Recommended Operating Conditions

Symbol	Description	Temperature Range	Speed Grade	Min	Typ	Max	Units
$V_{CCINT}$	Internal supply voltage relative to GND, $T_J = 0^\circ\text{C}$ to $+85^\circ\text{C}$	Commercial	-3, -2	1.14	1.2	1.26	V
	Internal supply voltage relative to GND, $T_J = -40^\circ\text{C}$ to $+100^\circ\text{C}$	Industrial	-2	1.14	1.2	1.26	V
	-1L		0.95	1.0	1.05	V	
$V_{CCAUX}^{(1)}$	Auxiliary supply voltage relative to GND when $V_{CCAUX} = 2.5\text{V}$ , $T_J = 0^\circ\text{C}$ to $+85^\circ\text{C}$	Commercial	-3, -2	2.375	2.5	2.625	V
	Auxiliary supply voltage relative to GND when $V_{CCAUX} = 2.5\text{V}$ , $T_J = -40^\circ\text{C}$ to $+100^\circ\text{C}$	Industrial	-2, -1L				
	Auxiliary supply voltage relative to GND when $V_{CCAUX} = 3.3\text{V}$ , $T_J = 0^\circ\text{C}$ to $+85^\circ\text{C}$	Commercial	-3, -2	3.15	3.3	3.45	V
	Auxiliary supply voltage relative to GND when $V_{CCAUX} = 3.3\text{V}$ , $T_J = -40^\circ\text{C}$ to $+100^\circ\text{C}$	Industrial	-2, -1L				
$V_{CCO}^{(2,3)}$	Output supply voltage relative to GND, $T_J = 0^\circ\text{C}$ to $+85^\circ\text{C}$	Commercial	-3, -2	1.1		3.45	V
	Output supply voltage relative to GND, $T_J = -40^\circ\text{C}$ to $+100^\circ\text{C}$	Industrial	-2, -1L				
$V_{IN}$	Input voltage relative to GND, $T_J = 0^\circ\text{C}$ to $+85^\circ\text{C}$	Commercial	-3, -2	-0.5		4.1	V
	Input voltage relative to GND, $T_J = -40^\circ\text{C}$ to $+100^\circ\text{C}$	Industrial	-2, -1L				
$V_{BATT}^{(4)}$	Battery voltage relative to GND, $T_J = 0^\circ\text{C}$ to $+85^\circ\text{C}$ (XC6SLX75, XC6SLX75T, XC6SLX100, XC6SLX100T, XC6SLX150, and XC6SLX150T only)	Commercial	-3, -2	1.0		3.6	V
	Battery voltage relative to GND, $T_J = -40^\circ\text{C}$ to $+100^\circ\text{C}$ (XC6SLX75, XC6SLX75T, XC6SLX100, XC6SLX100T, XC6SLX150, and XC6SLX150T only)	Industrial	-2, -1L				
$V_{FS}$	External voltage supply for eFUSE programming (XC6SLX75, XC6SLX75T, XC6SLX100, XC6SLX100T, XC6SLX150, and XC6SLX150T only). <sup>(6)</sup>	All	All	3.2	3.3	3.4	V
$R_{FUSE}$	External resistor for eFUSE programming (XC6SLX75, XC6SLX75T, XC6SLX100, XC6SLX100T, XC6SLX150, and XC6SLX150T only).	All	All	1129	1140	1151	$\Omega$

**Notes:**

1. Recommended maximum voltage droop for  $V_{CCAUX}$  is 10 mV/ms.
2. Configuration data is retained even if  $V_{CCO}$  drops to 0V.
3. Includes  $V_{CCO}$  of 1.2V, 1.5V, 1.8V, 2.5V, and 3.3V.
4.  $V_{BATT}$  is required only when using bitstream encryption. If battery is not used, connect  $V_{BATT}$  to either GND or  $V_{CCAUX}$ .
5. All voltages are relative to ground.
6. When not programming eFUSE, connect  $V_{FS}$  to  $V_{CCAUX}$ .

Table 3: DC Characteristics Over Recommended Operating Conditions

Symbol	Description	Speed Grade	Min	Typ	Max	Units
$V_{DRINT}$	Data retention $V_{CCINT}$ voltage (below which configuration data might be lost)	-3, -2	0.8			V
		-1L	0.8			V
$V_{DRAUX}$	Data retention $V_{CCAUX}$ voltage (below which configuration data might be lost)		2.0			V
$I_{REF}$	$V_{REF}$ leakage current per pin		-10		10	$\mu\text{A}$
$I_L$	Input or output leakage current per pin (sample-tested)		-10		10	$\mu\text{A}$
$C_{IN}$	Input capacitance (sample-tested)				10	pF

Table 3: DC Characteristics Over Recommended Operating Conditions (Cont'd)

Symbol	Description	Speed Grade	Min	Typ	Max	Units
I <sub>RPU</sub> <sup>(1)</sup>	Pad pull-up (when selected) @ V <sub>IN</sub> = 0V, V <sub>CCO</sub> = 3.3V or V <sub>CCAUX</sub> = 3.3V	-3, -2		332		μA
	Pad pull-up (when selected) @ V <sub>IN</sub> = 0V, V <sub>CCO</sub> = 2.5V or V <sub>CCAUX</sub> = 2.5V			217		μA
	Pad pull-up (when selected) @ V <sub>IN</sub> = 0V, V <sub>CCO</sub> = 1.8V			123		μA
	Pad pull-up (when selected) @ V <sub>IN</sub> = 0V, V <sub>CCO</sub> = 1.5V			87		μA
	Pad pull-up (when selected) @ V <sub>IN</sub> = 0V, V <sub>CCO</sub> = 1.2V			56		μA
I <sub>RPD</sub> <sup>(1)</sup>	Pad pull-up (when selected) @ V <sub>IN</sub> = 0V, V <sub>CCO</sub> = 3.3V or V <sub>CCAUX</sub> = 3.3V	-1L				μA
	Pad pull-up (when selected) @ V <sub>IN</sub> = 0V, V <sub>CCO</sub> = 2.5V or V <sub>CCAUX</sub> = 2.5V					μA
	Pad pull-up (when selected) @ V <sub>IN</sub> = 0V, V <sub>CCO</sub> = 1.8V					μA
	Pad pull-up (when selected) @ V <sub>IN</sub> = 0V, V <sub>CCO</sub> = 1.5V					μA
	Pad pull-up (when selected) @ V <sub>IN</sub> = 0V, V <sub>CCO</sub> = 1.2V					μA
I <sub>RPD</sub> <sup>(1)</sup>	Pad pull-down (when selected) @ V <sub>CCO</sub> = 2.5V, V <sub>CCAUX</sub> = 3.3V	-3, -2		341		μA
	Pad pull-down (when selected) @ V <sub>CCO</sub> = 2.5V, V <sub>CCAUX</sub> = 2.5V			229		μA
I <sub>RPD</sub> <sup>(1)</sup>	Pad pull-down (when selected) @ V <sub>CCO</sub> = 2.5V, V <sub>CCAUX</sub> = 3.3V	-1L				μA
	Pad pull-down (when selected) @ V <sub>CCO</sub> = 2.5V, V <sub>CCAUX</sub> = 2.5V					μA
I <sub>BATT</sub> <sup>(2)</sup>	Battery supply current (XC6SLX75, XC6SLX75T, XC6SLX100, XC6SLX100T, XC6SLX150, and XC6SLX150T only)				150	nA

Notes:

1. Typical values are specified at nominal voltage, 25°C.
2. Maximum value specified for worst case process at 25°C.

Important Note

Typical values for quiescent supply current are specified at nominal voltage, 25°C junction temperatures (T<sub>j</sub>). Xilinx recommends analyzing static power consumption at T<sub>j</sub> = 25°C. Quiescent supply current is specified by speed grade for Spartan-6 devices. Xilinx recommends analyzing static power consumption using the XPOWER™ Estimator (XPE) tool (download at <http://www.xilinx.com/power>) for conditions other than those specified in Table 4.

Table 4: Typical Quiescent Supply Current

Symbol	Description	Device	Speed Grade			Units
			-3	-2	-1L	
I <sub>CCINTQ</sub>	Quiescent V <sub>CCINT</sub> supply current	XC6SLX4	4.0	4.0	2.4	mA
		XC6SLX9	4.0	4.0	2.4	mA
		XC6SLX16	6.0	6.0	3.6	mA
		XC6SLX25	11.0	11.0	6.6	mA
		XC6SLX25T	11.0	11.0	N/A	mA
		XC6SLX45	18.0	18.0	10.8	mA
		XC6SLX45T	18.0	18.0	N/A	mA
		XC6SLX75				mA
		XC6SLX75T			N/A	mA
		XC6SLX100	36.0	36.0	21.6	mA
		XC6SLX100T	36.0	36.0	N/A	mA
		XC6SLX150	51.0	51.0	30.6	mA
		XC6SLX150T	51.0	51.0	N/A	mA

**Table 4: Typical Quiescent Supply Current (Cont'd)**

Symbol	Description	Device	Speed Grade			Units
			-3	-2	-1L	
I <sub>CCOQ</sub>	Quiescent V <sub>CCO</sub> supply current	XC6SLX4	1.0	1.0	1.0	mA
		XC6SLX9	1.0	1.0	1.0	mA
		XC6SLX16	2.0	2.0	2.0	mA
		XC6SLX25	2.0	2.0	2.0	mA
		XC6SLX25T	2.0	2.0	N/A	mA
		XC6SLX45	3.0	3.0	3.0	mA
		XC6SLX45T	3.0	3.0	N/A	mA
		XC6SLX75				mA
		XC6SLX75T			N/A	mA
		XC6SLX100	5.0	5.0	5.0	mA
		XC6SLX100T	5.0	5.0	N/A	mA
		XC6SLX150	7.0	7.0	7.0	mA
		XC6SLX150T	7.0	7.0	N/A	mA
I <sub>CCAUXQ</sub>	Quiescent V <sub>CCAUX</sub> supply current	XC6SLX4	3.0	3.0	3.0	mA
		XC6SLX9	3.0	3.0	3.0	mA
		XC6SLX16	3.0	3.0	3.0	mA
		XC6SLX25	4.0	4.0	4.0	mA
		XC6SLX25T	4.0	4.0	N/A	mA
		XC6SLX45	5.0	5.0	5.0	mA
		XC6SLX45T	5.0	5.0	N/A	mA
		XC6SLX75				mA
		XC6SLX75T			N/A	mA
		XC6SLX100	8.0	8.0	8.0	mA
		XC6SLX100T	8.0	8.0	N/A	mA
		XC6SLX150	12.0	12.0	12.0	mA
		XC6SLX150T	12.0	12.0	N/A	mA

**Notes:**

1. Typical values are specified at nominal voltage, 25°C junction temperatures (T<sub>j</sub>). Industrial (I) grade devices have the same typical values as commercial (C) grade devices at 25°C, but higher values at 100°C. Use the XPE tool to calculate 100°C values.
2. Typical values are for blank configured devices with no output current loads, no active input pull-up resistors, all I/O pins are 3-state and floating.
3. If differential signaling is used, more accurate quiescent current estimates can be obtained by using the XPOWER Estimator (XPE) or XPOWER Analyzer (XPA) tools.

**Table 5: Power Supply Ramp Time**

Symbol	Description	Speed Grade	Ramp Time	Units
V <sub>CCINTR</sub>	Internal supply voltage ramp time	-3, -2	0.20 to 50.0	ms
		-1L	0.20 to 40.0	ms
V <sub>CCOR</sub>	Output drivers supply voltage ramp time	All	0.20 to 50.0	ms
V <sub>CCAUXR</sub>	Auxiliary supply voltage ramp time	All	0.20 to 50.0	ms

## SelectIO™ Interface DC Input and Output Levels

Values for  $V_{IL}$  and  $V_{IH}$  are recommended input voltages. Values for  $I_{OL}$  and  $I_{OH}$  are guaranteed over the recommended operating conditions at the  $V_{OL}$  and  $V_{OH}$  test points. Only selected standards are tested. These are chosen to ensure that all standards meet their specifications. The selected standards are tested at a minimum  $V_{CCO}$  with the respective  $V_{OL}$  and  $V_{OH}$  voltage levels shown. Other standards are sample tested.

Table 6: Single-Ended I/O Standard DC Input and Output Levels

I/O Standard	$V_{IL}$		$V_{IH}$		$V_{OL}$	$V_{OH}$	$I_{OL}$	$I_{OH}$
	V, Min	V, Max	V, Min	V, Max	V, Max	V, Min	mA	mA
LVTTTL	-0.5	0.8	2.0	4.1	0.4	2.4	Note(2)	Note(2)
LVC MOS33	-0.5	0.8	2.0	4.1	0.4	$V_{CCO} - 0.4$	Note(2)	Note(2)
LVC MOS25	-0.5	0.7	1.7	4.1	0.4	$V_{CCO} - 0.4$	Note(2)	Note(2)
LVC MOS18	-0.5	0.38	0.8	4.1	0.45	$V_{CCO} - 0.45$	Note(2)	Note(2)
LVC MOS18_JEDEC	-0.5	35% $V_{CCO}$	65% $V_{CCO}$	4.1	0.45	$V_{CCO} - 0.45$	Note(2)	Note(2)
LVC MOS15	-0.5	0.38	0.8	4.1	25% $V_{CCO}$	75% $V_{CCO}$	Note(3)	Note(3)
LVC MOS15_JEDEC	-0.5	35% $V_{CCO}$	65% $V_{CCO}$	4.1	25% $V_{CCO}$	75% $V_{CCO}$	Note(3)	Note(3)
LVC MOS12	-0.5	0.38	0.8	4.1	0.4	$V_{CCO} - 0.4$	Note(4)	Note(4)
LVC MOS12_JEDEC	-0.5	35% $V_{CCO}$	65% $V_{CCO}$	4.1	0.4	$V_{CCO} - 0.4$	Note(4)	Note(4)
PCI33_3 <sup>(5)</sup>	-0.5	30% $V_{CCO}$	50% $V_{CCO}$	$V_{CCO} + 0.5$	10% $V_{CCO}$	90% $V_{CCO}$	Note(5)	Note(5)
PCI66_3 <sup>(5)</sup>	-0.5	30% $V_{CCO}$	50% $V_{CCO}$	$V_{CCO} + 0.5$	10% $V_{CCO}$	90% $V_{CCO}$	Note(5)	Note(5)
I2C	-0.5	30% $V_{CCO}$	70% $V_{CCO}$	4.1	20% $V_{CCO}$	-	3	-
SMBUS	-0.5	0.8	2.1	4.1	0.4	-	4	-
SDIO	-0.5	12.5% $V_{CCO}$	75% $V_{CCO}$	4.1	12.5% $V_{CCO}$	75% $V_{CCO}$	0.1	-0.1
MOBILE_DDR	-0.5	20% $V_{CCO}$	80% $V_{CCO}$	4.1	10% $V_{CCO}$	90% $V_{CCO}$	0.1	-0.1
HSTL_I	-0.5	$V_{REF} - 0.1$	$V_{REF} + 0.1$	4.1	0.4	$V_{CCO} - 0.4$	8	-8
HSTL_II	-0.5	$V_{REF} - 0.1$	$V_{REF} + 0.1$	4.1	0.4	$V_{CCO} - 0.4$	16	-16
HSTL_III	-0.5	$V_{REF} - 0.1$	$V_{REF} + 0.1$	4.1	0.4	$V_{CCO} - 0.4$	24	-8
HSTL_I_18	-0.5	$V_{REF} - 0.1$	$V_{REF} + 0.1$	4.1	0.4	$V_{CCO} - 0.4$	11	-11
HSTL_II_18	-0.5	$V_{REF} - 0.1$	$V_{REF} + 0.1$	4.1	0.4	$V_{CCO} - 0.4$	22	-22
HSTL_III_18	-0.5	$V_{REF} - 0.1$	$V_{REF} + 0.1$	4.1	0.4	$V_{CCO} - 0.4$	30	-11
SSTL3_I	-0.5	$V_{REF} - 0.2$	$V_{REF} + 0.2$	4.1	$V_{TT} - 0.6$	$V_{TT} + 0.6$	8	-8
SSTL3_II	-0.5	$V_{REF} - 0.2$	$V_{REF} + 0.2$	4.1	$V_{TT} - 0.8$	$V_{TT} + 0.8$	16	-16
SSTL2_I	-0.5	$V_{REF} - 0.15$	$V_{REF} + 0.15$	4.1	$V_{TT} - 0.61$	$V_{TT} + 0.61$	8.1	-8.1
SSTL2_II	-0.5	$V_{REF} - 0.15$	$V_{REF} + 0.15$	4.1	$V_{TT} - 0.81$	$V_{TT} + 0.81$	16.2	-16.2
SSTL18_I	-0.5	$V_{REF} - 0.125$	$V_{REF} + 0.125$	4.1	$V_{TT} - 0.47$	$V_{TT} + 0.47$	6.7	-6.7
SSTL18_II	-0.5	$V_{REF} - 0.125$	$V_{REF} + 0.125$	4.1	$V_{TT} - 0.60$	$V_{TT} + 0.60$	13.4	-13.4
SSTL15_II	-0.5	$V_{REF} - 0.1$	$V_{REF} + 0.1$	4.1	$V_{TT} - 0.4$	$V_{TT} + 0.4$	13.4	-13.4

### Notes:

1. Tested according to relevant specifications.
2. Using drive strengths of 2, 4, 6, 8, 12, 16, or 24 mA.
3. Using drive strengths of 2, 4, 6, 8, 12, or 16 mA.
4. Using drive strengths of 2, 4, 6, 8, or 12 mA.
5. For more information on PCI33\_3 and PCI66\_3 refer to refer to the [Spartan-6 FPGA SelectIO Resources User Guide](#).

Table 7: Differential I/O Standard DC Input and Output Levels

I/O Standard	V <sub>ID</sub>		V <sub>ICM</sub>		V <sub>OD</sub>		V <sub>OCM</sub>		V <sub>OH</sub>	V <sub>OL</sub>
	mV, Min	mV, Max	V, Min	V, Max	mV, Min	mV, Max	V, Min	V, Max	V, Min	V, Max
LVDS_33	100	600	0.3	2.35	247	454	1.125	1.375	–	–
LVDS_25	100	600	0.3	2.35	247	454	1.125	1.375	–	–
BLVDS_25	100	–	0.3	2.35	240	460	Typical 50% V <sub>CCO</sub>		–	–
MINI_LVDS_33	200	600	0.3	1.95	300	600	1.0	1.4	–	–
MINI_LVDS_25	200	600	0.3	1.95	300	600	1.0	1.4	–	–
LVPECL_33	100	1000	0.3	2.8	Inputs only					
LVPECL_25	100	1000	0.3	1.95	Inputs only					
RSDS_33	100	–	0.3	1.5	100	400	1.0	1.4	–	–
RSDS_25	100	–	0.3	1.5	100	400	1.0	1.4	–	–
TMDS_33	150	1200	2.7	3.23	400	600	V <sub>CCO</sub> – 0.3	V <sub>CCO</sub> – 0.19	–	–
PPDS_33	100	400	0.2	2.3	100	400	0.5	1.4	–	–
PPDS_25	100	400	0.2	2.3	100	400	0.5	1.4	–	–
DISPLAY_PORT	190	1260	0.3	2.35	–	–	Typical 50% V <sub>CCO</sub>		–	–
DIFF_HSTL_I	100	–	0.68	0.9	–	–	–	–	V <sub>CCO</sub> – 0.4	0.4
DIFF_HSTL_II	100	–	0.68	0.9	–	–	–	–	V <sub>CCO</sub> – 0.4	0.4
DIFF_HSTL_III	100	–	0.68	0.9	–	–	–	–	V <sub>CCO</sub> – 0.4	0.4
DIFF_HSTL_I_18	100	–	0.8	1.1	–	–	–	–	V <sub>CCO</sub> – 0.4	0.4
DIFF_HSTL_II_18	100	–	0.8	1.1	–	–	–	–	V <sub>CCO</sub> – 0.4	0.4
DIFF_HSTL_III_18	100	–	0.8	1.1	–	–	–	–	V <sub>CCO</sub> – 0.4	0.4
DIFF_SSTL3_I	100	–	1.0	1.9	–	–	–	–	V <sub>TT</sub> + 0.6	V <sub>TT</sub> – 0.6
DIFF_SSTL3_II	100	–	1.0	1.9	–	–	–	–	V <sub>TT</sub> + 0.8	V <sub>TT</sub> – 0.8
DIFF_SSTL2_I	100	–	1.0	1.5	–	–	–	–	V <sub>TT</sub> + 0.61	V <sub>TT</sub> – 0.61
DIFF_SSTL2_II	100	–	1.0	1.5	–	–	–	–	V <sub>TT</sub> + 0.81	V <sub>TT</sub> – 0.81
DIFF_SSTL18_I	100	–	0.7	1.1	–	–	–	–	V <sub>TT</sub> + 0.47	V <sub>TT</sub> – 0.47
DIFF_SSTL18_II	100	–	0.7	1.1	–	–	–	–	V <sub>TT</sub> + 0.6	V <sub>TT</sub> – 0.6
DIFF_SSTL15_II	100	–	0.55	0.95	–	–	–	–	V <sub>TT</sub> + 0.4	V <sub>TT</sub> – 0.4

Table 8: eFUSE Read Endurance

Symbol	Description	Speed Grade			Units
		-3	-2	-1L	
DNA_CYCLES	Number of DNA_PORT READ operations or JTAG ISC_DNA read command operations. Unaffected by SHIFT operations.	30,000,000			Read Cycles
AES_CYCLES	Number of JTAG FUSE_KEY or FUSE_CNTL read command operations. Unaffected by SHIFT operations.	30,000,000			Read Cycles

## GTP Transceiver Specifications

### GTP Transceiver DC Characteristics

Table 9: Absolute Maximum Ratings for GTP Transceivers

Symbol	Description	Specification	Units
MGTAVCC	Analog supply voltage for the GTP transmitter and receiver circuits relative to GND	-0.5 to 1.32	V
MGTAVTTTX	Analog supply voltage for the GTP transmitter termination circuit relative to GND	-0.5 to 1.32	V
MGTAVTTRX	Analog supply voltage for the GTP receiver termination circuit relative to GND	-0.5 to 1.32	V
MGTAVCCPLL	Analog supply voltage for the GTP transmitter and receiver PLL circuits relative to GND	-0.5 to 1.32	V
MGTAVTTRCAL	Analog supply voltage for the resistor calibration circuit of the GTP transceiver bank (top or bottom)	-0.5 to 1.32	V
$V_{IN}$	Receiver (RXP/RXN) and Transmitter (TXP/TXN) absolute input voltage		V
$V_{MGTREFCLK}$	Reference clock absolute input voltage		V

**Notes:**

- Stresses beyond those listed under Absolute Maximum Ratings might cause permanent damage to the device. These are stress ratings only, and functional operation of the device at these or any other conditions beyond those listed under Operating Conditions is not implied. Exposure to Absolute Maximum Ratings conditions for extended periods of time might affect device reliability.

Table 10: Recommended Operating Conditions for GTP Transceivers<sup>(1)(2)</sup>

Symbol	Description	Min	Max	Units
MGTAVCC	Analog supply voltage for the GTP transmitter and receiver circuits relative to GND	1.14	1.26	V
MGTAVTTTX	Analog supply voltage for the GTP transmitter termination circuit relative to GND	1.14	1.26	V
MGTAVTTRX	Analog supply voltage for the GTP receiver termination circuit relative to GND	1.14	1.26	V
MGTAVCCPLL	Analog supply voltage for the GTP transmitter and receiver PLL circuits relative to GND	1.14	1.26	V
MGTAVTTRCAL	Analog supply voltage for the resistor calibration circuit of the GTP transceiver bank (top or bottom)	1.14	1.26	V

**Notes:**

- Each voltage listed requires the filter circuit described in *Spartan-6 FPGA GTP Transceiver User Guide*.
- Voltages are specified for the temperature range of  $T_J = -40^{\circ}\text{C}$  to  $+100^{\circ}\text{C}$ .

Table 11: DC Characteristics Over Recommended Operating Conditions for GTP Transmitters<sup>(1)</sup>

Symbol	Description	Min	Typ	Max	Units
$I_{MGTAVCC}$	GTP transceiver internal analog supply current				mA
$I_{MGTAVTTTX}$	GTP transmitter termination supply current <sup>(2)</sup>				mA
$I_{MGTAVTTRX}$	GTP receiver termination supply current <sup>(2)</sup>				mA
$I_{MGTAVCCPLL}$	GTP transmitter and receiver PLL supply current				mA
$I_{MGTAVTTRCAL}$	GTP transceiver resistor termination calibration supply current				mA
MGTRREF	Precision reference resistor for internal calibration termination	50.0 ± 1% tolerance			$\Omega$

**Notes:**

- Typical values are specified at nominal voltage, 25°C, with a 3.125 Gb/s line rate.
- $I_{CC}$  numbers are given per GTP transceiver operating with default settings.
- Values for currents other than the values specified in this table can be obtained by using the XPOWER Estimator (XPE) or XPOWER Analyzer (XPA) tools.

Table 12: GTP Transceiver Quiescent Supply Current

Symbol	Description	Typ <sup>(1)</sup>	Max	Units
I <sub>AVTTQ</sub>	Quiescent MGTAVTT (transmitter termination) supply current			mA
I <sub>AVCCQ</sub>	Quiescent MGTAVCC (analog) supply current			mA

Notes:

1. Typical values are specified at nominal voltage, 25°C.
2. Device powered and unconfigured.
3. Currents for conditions other than values specified in this table can be obtained by using the XPOWER Estimator (XPE) or XPOWER Analyzer (XPA) tools.
4. GTP transceiver quiescent supply current for an entire device can be calculated by multiplying the values in this table by the number of available GTP transceivers.

### GTP Transceiver DC Input and Output Levels

Table 13 summarizes the DC output specifications of the GTP transceivers in Spartan-6 FPGAs. Figure 1 shows the single-ended output voltage swing. Figure 2 shows the peak-to-peak differential output voltage.

Consult the [Spartan-6 FPGA GTP Transceiver User Guide](#) for further details.

Table 13: GTP Transceiver DC Specifications

Symbol	DC Parameter	Conditions	Min	Typ	Max	Units
DV <sub>PPIN</sub>	Differential peak-to-peak input voltage	External AC coupled	125		2000	mV
V <sub>IN</sub>	Input voltage	DC coupled MGTAVTTRX = 1.2V	-400		MGTAVTTRX	mV
V <sub>CMIN</sub>	Common mode input voltage	DC coupled MGTAVTTRX = 1.2V		2/3 MGTAVTTRX		mV
DV <sub>PPOUT</sub>	Differential peak-to-peak output voltage <sup>(1)</sup>				1000	mV
V <sub>SEOUT</sub>	Single-ended output voltage swing <sup>(1)</sup>				500	mV
V <sub>CMOUT</sub>	Common mode output voltage	Equation based	MGTAVTTTX - V <sub>SEOUT</sub> /2			mV
R <sub>IN</sub>	Differential input resistance			100		Ω
R <sub>OUT</sub>	Differential output resistance			100		Ω
T <sub>OSKEW</sub>	Transmitter output skew					ps
C <sub>EXT</sub>	Recommended external AC coupling capacitor <sup>(2)</sup>		75	100	200	nF

Notes:

1. The output swing and preemphasis levels are programmable using the attributes discussed in [Spartan-6 FPGA GTP Transceiver User Guide](#) and can result in values lower than reported in this table.
2. Other values can be used as appropriate to conform to specific protocols and standards.

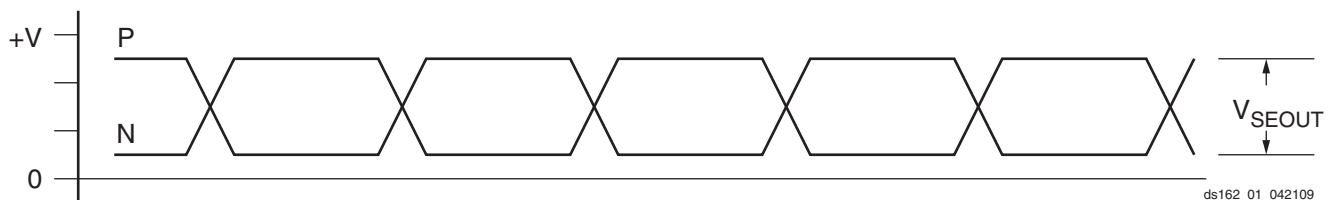

Figure 1: Single-Ended Output Voltage Swing



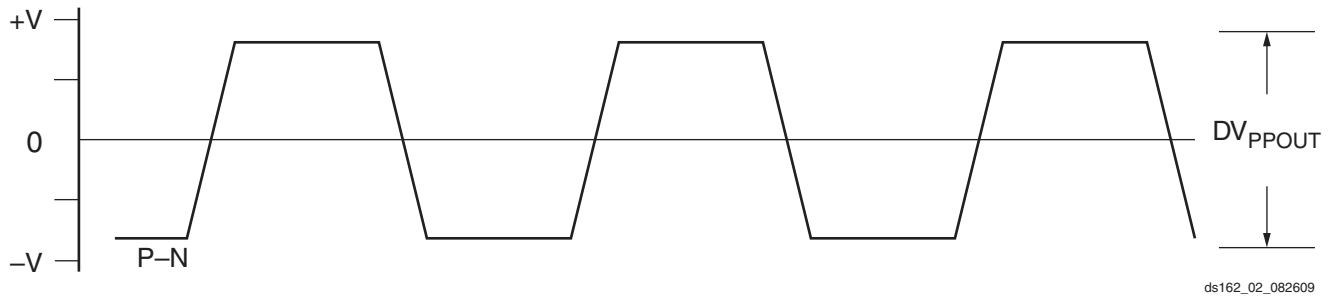

Figure 2: Peak-to-Peak Differential Output Voltage

Table 14 summarizes the DC specifications of the clock input of the GTP transceiver. Figure 3 shows the single-ended input voltage swing. Figure 4 shows the peak-to-peak differential clock input voltage swing. Consult the [Spartan-6 FPGA GTP Transceiver User Guide](#) for further details.

Table 14: GTP Transceiver Clock DC Input Level Specification<sup>(1)</sup>

Symbol	DC Parameter	Conditions	Min	Typ	Max	Units
$V_{IDIFF}$	Differential peak-to-peak input voltage			800		mV
$V_{ISE}$	Single-ended input voltage			400		mV
$R_{IN}$	Differential input resistance			100		$\Omega$
$C_{EXT}$	Required external AC coupling capacitor			100		nF

Notes:

- $V_{MIN} = 0V$  and  $V_{MAX} = MGTAVCC$

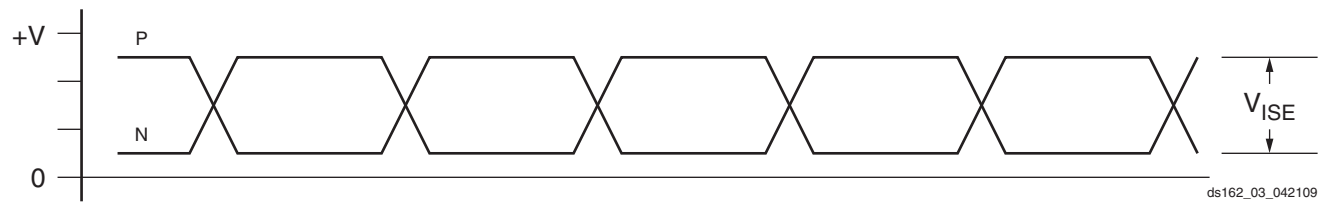

Figure 3: Single-Ended Clock Input Voltage Swing Peak-to-Peak

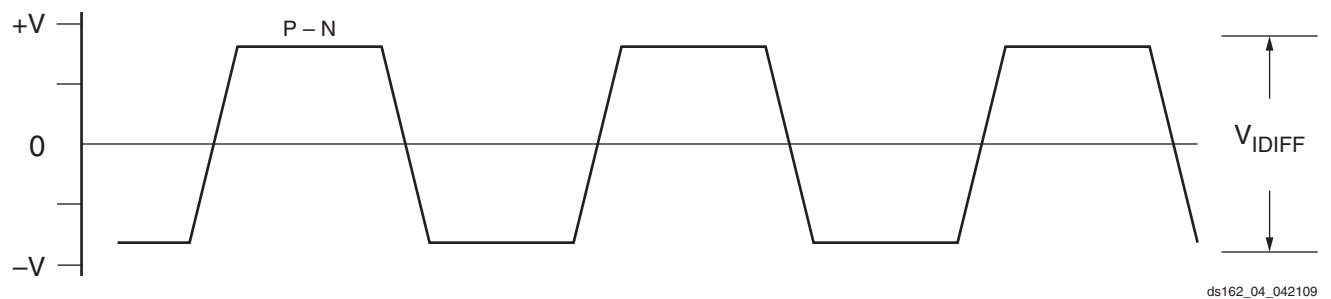

Figure 4: Differential Clock Input Voltage Swing Peak-to-Peak

## GTP Transceiver Switching Characteristics

Consult the [Spartan-6 FPGA GTP Transceiver User Guide](#) for further information.

Table 15: GTP Transceiver Performance

Symbol	Description	Speed Grade			Units
		-3	-2	-1L	
F <sub>GTPMAX</sub>	Maximum GTP transceiver data rate	3.125	2.7	N/A	Gb/s
F <sub>GPLLMAX</sub>	Maximum PLL frequency	1.62	1.62	N/A	GHz
F <sub>GPLLMIN</sub>	Minimum PLL frequency	1.2	1.2	N/A	GHz

Table 16: Dynamic Reconfiguration Port (DRP) in the GTP Transceiver Switching Characteristics

Symbol	Description	Speed Grade			Units
		-3	-2	-1L	
F <sub>GTPDRPCLK</sub>	GTPDRPCLK maximum frequency	100	100	N/A	MHz

Table 17: GTP Transceiver Reference Clock Switching Characteristics

Symbol	Description	Conditions	All Speed Grades			Units
			Min	Typ	Max	
F <sub>GCLK</sub>	Reference clock frequency range		60		160	MHz
T <sub>RCLK</sub>	Reference clock rise time	20% – 80%		200		ps
T <sub>FCLK</sub>	Reference clock fall time	80% – 20%		200		ps
T <sub>DCREF</sub>	Reference clock duty cycle	Transceiver PLL only	45	50	55	%
T <sub>LOCK</sub>	Clock recovery frequency acquisition time	Initial PLL lock			1	ms
T <sub>PHASE</sub>	Clock recovery phase acquisition time	Lock to data after PLL has locked to the reference clock				μs

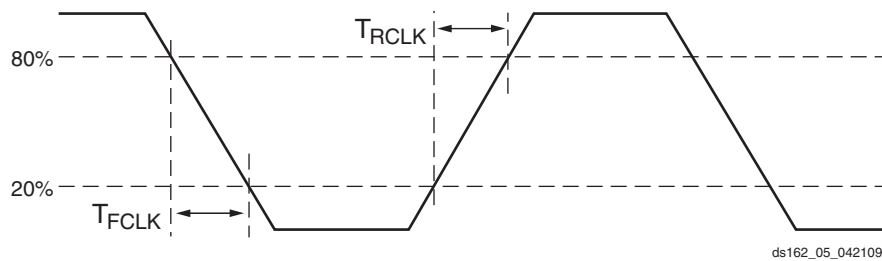

Figure 5: Reference Clock Timing Parameters

Table 18: GTP Transceiver User Clock Switching Characteristics<sup>(1)</sup>

Symbol	Description	Conditions	Speed Grade			Units
			-3	-2	-1L	
F <sub>TXOUT</sub>	TXOUTCLK maximum frequency	Internal 10-bit data path			N/A	MHz
		Internal 8-bit data path			N/A	MHz
F <sub>RXREC</sub>	RXRECCLK maximum frequency				N/A	MHz
T <sub>RX</sub>	RXUSRCLK maximum frequency				N/A	MHz
T <sub>RX2</sub>	RXUSRCLK2 maximum frequency	1 byte interface			N/A	MHz
		2 byte interface			N/A	MHz
		4 byte interface			N/A	MHz
T <sub>TX</sub>	TXUSRCLK maximum frequency				N/A	MHz
T <sub>TX2</sub>	TXUSRCLK2 maximum frequency	1 byte interface			N/A	MHz
		2 byte interface			N/A	MHz
		4 byte interface			N/A	MHz
T <sub>DCUSRCLK</sub>	TXUSRCLK, TXUSRCLK2, RXUSRCLK, and RXUSRCLK2 duty cycle	1 byte interface			N/A	%
		2 byte interface			N/A	%
		4 byte interface			N/A	%

Notes:

1. Clocking must be implemented as described in [Spartan-6 FPGA GTP Transceiver User Guide](#).

Table 19: GTP Transceiver Transmitter Switching Characteristics

Symbol	Description	Condition	Min	Typ	Max	Units
F <sub>GTPTX</sub>	Serial data rate range		0.600		F <sub>GTPTMAX</sub>	Gb/s
T <sub>RTX</sub>	TX Rise time	20%–80%				ps
T <sub>FTX</sub>	TX Fall time	80%–20%				ps
T <sub>LLSKEW</sub>	TX lane-to-lane skew <sup>(1)</sup>					ps
V <sub>TXOOBVDPP</sub>	Electrical idle amplitude				20	mV
T <sub>TXOOBTRANSITION</sub>	Electrical idle transition time					ns
T <sub>J3.125</sub>	Total Jitter <sup>(2)</sup>	3.125 Gb/s				UI
D <sub>J3.125</sub>	Deterministic Jitter <sup>(2)</sup>					UI
T <sub>J2.5</sub>	Total Jitter <sup>(2)</sup>	2.5 Gb/s				UI
D <sub>J2.5</sub>	Deterministic Jitter <sup>(2)</sup>					UI
T <sub>J1.62</sub>	Total Jitter <sup>(2)</sup>	1.62 Gb/s				UI
D <sub>J1.62</sub>	Deterministic Jitter <sup>(2)</sup>					UI
T <sub>J1.25</sub>	Total Jitter <sup>(2)</sup>	1.25 Gb/s				UI
D <sub>J1.25</sub>	Deterministic Jitter <sup>(2)</sup>					UI
T <sub>J614</sub>	Total Jitter <sup>(2)</sup>	614 Mb/s				UI
D <sub>J614</sub>	Deterministic Jitter <sup>(2)</sup>					UI

Notes:

1. Using same REFCLK input with TXENPMAPHASEALIGN enabled for up to four consecutive GTP transceiver sites.
2. Using PLL\_DIVSEL\_FB = 2, INTDATAWIDTH = 1. These values are NOT intended for protocol specific compliance determinations.

Table 20: GTP Transceiver Receiver Switching Characteristics

Symbol	Description		Min	Typ	Max	Units
$F_{GTPRX}$	Serial data rate		0.600		$F_{GTPMAX}$	Gb/s
$T_{RXELECIDLE}$	Time for RXELECIDLE to respond to loss or restoration of data					ns
$R_{XOOBVDPP}$	OOB detect threshold peak-to-peak		60		150	mV
$R_{XSST}$	Receiver spread-spectrum tracking <sup>(1)</sup>	Modulated @ 33 KHz				ppm
$R_{XRL}$	Run length (CID)	Internal AC capacitor bypassed				UI
$R_{XPPMTOL}$	Data/REFCLK PPM offset tolerance	CDR 2 <sup>nd</sup> -order loop disabled				ppm
		CDR 2 <sup>nd</sup> -order loop enabled				ppm
<b>SJ Jitter Tolerance<sup>(2)</sup></b>						
$JT\_SJ_{3.125}$	Sinusoidal Jitter <sup>(3)</sup>	3.125 Gb/s				UI
$JT\_SJ_{2.5}$	Sinusoidal Jitter <sup>(3)</sup>	2.5 Gb/s				UI
$JT\_SJ_{1.62}$	Sinusoidal Jitter <sup>(3)</sup>	1.62 Gb/s				UI
$JT\_SJ_{1.25}$	Sinusoidal Jitter <sup>(3)</sup>	1.25 Gb/s				UI
$JT\_SJ_{614}$	Sinusoidal Jitter <sup>(3)</sup>	614 Mb/s				UI
<b>SJ Jitter Tolerance with Stressed Eye<sup>(2)</sup></b>						
$JT\_TJSE_{3.125}$	Total Jitter with Stressed Eye	3.125 Gb/s				UI

**Notes:**

- Using PLL\_RXDIVSEL\_OUT = 1, 2, and 4.
- All jitter values are based on a Bit Error Ratio of  $1e^{-12}$ .
- Using 80 MHz sinusoidal jitter only in the absence of deterministic and random jitter.

## Endpoint Block for PCI Express Designs Switching Characteristics

Consult [Spartan-6 FPGA Integrated Endpoint Block for PCI Express](#) for further information.

Table 21: Maximum Performance for PCI Express Designs

Symbol	Description	Speed Grade			Units
		-3	-2	-1L	
F <sub>PCIEUSER</sub>	User clock maximum frequency	62.5	62.5	N/A	MHz

## Performance Characteristics

This section provides the performance characteristics of some common functions and designs implemented in Spartan-6 devices. The numbers reported here are worst-case values; they have all been fully characterized. These values are subject to the same guidelines as the [Switching Characteristics, page 14](#).

Table 22: Interface Performances

Description	Speed Grade		
	-3	-2	-1L
<b>Networking Applications</b>			
SDR LVDS transmitter (using IOB SDR register)			
DDR LVDS transmitter (using IOB ODDR2 register)			
SDR LVDS transmitter (using OSERDES2; DATA WIDTH = 2 to 8)			
DDR LVDS transmitter (using OSERDES2; DATA WIDTH = 2 to 8)	1.05 Gb/s		
SDR LVDS receiver (1:7 / 7:1 video link (LDI interface)) <sup>(1)</sup>			
<b>Memory Interfaces (Implemented using the Spartan-6 FPGA Memory Controller Block)</b>			
DDR	400 Mb/s		
DDR2	800 Mb/s		
DDR3	800 Mb/s		
Mobile_DDR	400 Mb/s		

**Notes:**

1. LVDS receivers are typically bounded with certain applications where specific DPA algorithms dominate deterministic performance. Please refer to actual application notes for details.

## Switching Characteristics

All values represented in this data sheet are based on an advanced speed specification (version 1.0). Switching characteristics are specified on a per-speed-grade basis and can be designated as Advance, Preliminary, or Production. Each designation is defined as follows:

### Advance

These specifications are based on simulations only and are typically available soon after device design specifications are frozen. Although speed grades with this designation are considered relatively stable and conservative, some under-reporting might still occur.

### Preliminary

These specifications are based on complete ES (engineering sample) silicon characterization. Devices and speed grades with this designation are intended to give a better indication of the expected performance of production silicon. The probability of under-reporting delays is greatly reduced as compared to Advance data.

### Production

These specifications are released once enough production silicon of a particular device family member has been characterized to provide full correlation between specifications and devices over numerous production lots. There is no under-reporting of delays, and customers receive formal notification of any subsequent changes. Typically, the slowest speed grades transition to Production before faster speed grades.

All specifications are always representative of worst-case supply voltage and junction temperature conditions.

Since individual family members are produced at different times, the migration from one category to another depends completely on the status of the fabrication process for each device.

Table 23 correlates the current status of each Spartan-6 device on a per speed grade basis.

Table 23: Spartan-6 Device Speed Grade Designations

Device	Speed Grade Designations		
	Advance	Preliminary	Production
XC6SLX4	-2		
XC6SLX9	-2		
XC6SLX16	-2		
XC6SLX25	-2		
XC6SLX25T	-2		
XC6SLX45	-2		
XC6SLX45T	-2		
XC6SLX75	-2		
XC6SLX75T	-2		
XC6SLX100	-2		
XC6SLX100T	-2		
XC6SLX150	-2		
XC6SLX150T	-2		

## Testing of Switching Characteristics

All devices are 100% functionally tested. Internal timing parameters are derived from measuring internal test patterns. Listed below are representative values.

For more specific, more precise, and worst-case guaranteed data, use the values reported by the static timing analyzer and back-annotate to the simulation net list. Unless otherwise noted, values apply to all Spartan-6 devices.

## Production Silicon and ISE Software Status

In some cases, a particular family member (and speed grade) is released to production before a speed specification is released with the correct label (Advance, Preliminary, Production). Any labeling discrepancies are corrected in subsequent speed specification releases. Table 24 lists the production released Spartan-6 family member, speed grade, and the minimum corresponding supported speed specification version and ISE software revisions. The ISE™ software and speed specifications listed are the minimum releases required for production. All subsequent releases of software and speed specifications are valid.

Table 24: Spartan-6 Device Production Software and Speed Specification Release

Device	Speed Grade Designations		
	-3	-2	-1L
XC6SLX4			
XC6SLX9			
XC6SLX16			
XC6SLX25			
XC6SLX25T			N/A
XC6SLX45			
XC6SLX45T			N/A
XC6SLX75			
XC6SLX75T			N/A
XC6SLX100			
XC6SLX100T			N/A
XC6SLX150			
XC6SLX150T			N/A

**Notes:**

- Blank entries indicate a device and/or speed grade in advance or preliminary status.

## IOB Pad Input/Output/3-State Switching Characteristics

Table 25 summarizes the values of standard-specific data input delay adjustments, output delays terminating at pads (based on standard) and 3-state delays.

$T_{IOP1}$  is described as the delay from IOB pad through the input buffer to the I-pin of an IOB pad. The delay varies depending on the capability of the SelectIO input buffer.

$T_{IOOP}$  is described as the delay from the O pin to the IOB pad through the output buffer of an IOB pad. The delay varies depending on the capability of the SelectIO output buffer.

$T_{IOTP}$  is described as the delay from the T pin to the IOB pad through the output buffer of an IOB pad, when 3-state is disabled. The delay varies depending on the SelectIO capability of the output buffer.

Table 26 summarizes the value of  $T_{IOTPHZ}$ .  $T_{IOTPHZ}$  is described as the delay from the T pin to the IOB pad through the output buffer of an IOB pad, when 3-state is enabled (i.e., a high impedance state).

Table 25: IOB Switching Characteristics

I/O Standard	$T_{IOP1}$			$T_{IOOP}$			$T_{IOTP}$			Units
	Speed Grade			Speed Grade			Speed Grade			
	-3	-2	-1L	-3	-2	-1L	-3	-2	-1L	
LVDS_33		1.50			1.90			1.90		ns
LVDS_25		1.36			2.03			2.03		ns
BLVDS_25		1.36			2.18			2.18		ns
MINI_LVDS_33		1.50			1.89			1.89		ns
MINI_LVDS_25		1.36			2.03			2.03		ns
LVPECL_33		1.50			N/A			N/A		ns
LVPECL_25		1.36			N/A			N/A		ns

Table 25: IOB Switching Characteristics (Cont'd)

I/O Standard	T <sub>IOPI</sub>			T <sub>IOOP</sub>			T <sub>IOTP</sub>			Units
	Speed Grade			Speed Grade			Speed Grade			
	-3	-2	-1L	-3	-2	-1L	-3	-2	-1L	
RSDS_33 (point to point)		1.50			1.90			1.90		ns
RSDS_25 (point to point)		1.36			2.02			2.02		ns
TMDS_33		1.53			1.85			1.85		ns
PPDS_33		1.50			1.90			1.90		ns
PPDS_25		1.36			2.03			2.03		ns
DISPLAY_PORT		1.36			3.32			3.32		ns
I2C		1.66			6.39			6.39		ns
SMBUS		1.66			6.39			6.39		ns
SDIO		1.69			3.03			3.03		ns
MOBILE_DDR		1.26			2.83			2.83		ns
HSTL_I		1.22			1.99			1.99		ns
HSTL_II		1.22			1.98			1.98		ns
HSTL_III		1.28			2.01			2.01		ns
HSTL_I_18		1.27			2.02			2.02		ns
HSTL_II_18		1.27			2.05			2.05		ns
HSTL_III_18		1.32			1.94			1.94		ns
SSTL3_I		1.92			1.98			1.98		ns
SSTL3_II		1.92			2.02			2.02		ns
SSTL2_I		1.63			1.94			1.94		ns
SSTL2_II		1.64			1.99			1.99		ns
SSTL18_I		1.23			1.89			1.89		ns
SSTL18_II		1.22			1.92			1.92		ns
SSTL15_II		1.20			1.95			1.95		ns
DIFF_HSTL_I		1.27			2.03			2.03		ns
DIFF_HSTL_II		1.27			1.99			1.99		ns
DIFF_HSTL_III		1.27			1.97			1.97		ns
DIFF_HSTL_I_18		1.31			2.05			2.05		ns
DIFF_HSTL_II_18		1.30			1.97			1.97		ns
DIFF_HSTL_III_18		1.31			1.99			1.99		ns
DIFF_SSTL3_I		1.50			2.03			2.03		ns
DIFF_SSTL3_II		1.50			2.06			2.06		ns
DIFF_SSTL2_I		1.36			2.05			2.05		ns
DIFF_SSTL2_II		1.36			2.03			2.03		ns
DIFF_SSTL18_I		1.31			1.97			1.97		ns
DIFF_SSTL18_II		1.31			1.97			1.97		ns
DIFF_SSTL15_II		1.28			1.95			1.95		ns



Table 25: IOB Switching Characteristics (Cont'd)

I/O Standard	T <sub>IOP1</sub>			T <sub>IOP</sub>			T <sub>IOTP</sub>			Units
	Speed Grade			Speed Grade			Speed Grade			
	-3	-2	-1L	-3	-2	-1L	-3	-2	-1L	
LVTTL, QUIETIO, 2 mA		1.69			5.68			5.68		ns
LVTTL, QUIETIO, 4 mA		1.69			4.55			4.55		ns
LVTTL, QUIETIO, 6 mA		1.69			4.07			4.07		ns
LVTTL, QUIETIO, 8 mA		1.69			3.59			3.59		ns
LVTTL, QUIETIO, 12 mA		1.69			3.60			3.60		ns
LVTTL, QUIETIO, 16 mA		1.69			3.31			3.31		ns
LVTTL, QUIETIO, 24 mA		1.69			3.10			3.10		ns
LVTTL, Slow, 2 mA		1.69			4.73			4.73		ns
LVTTL, Slow, 4 mA		1.69			3.57			3.57		ns
LVTTL, Slow, 6 mA		1.69			3.18			3.18		ns
LVTTL, Slow, 8 mA		1.69			3.03			3.03		ns
LVTTL, Slow, 12 mA		1.69			2.94			2.94		ns
LVTTL, Slow, 16 mA		1.69			2.81			2.81		ns
LVTTL, Slow, 24 mA		1.69			2.53			2.53		ns
LVTTL, Fast, 2 mA		1.69			4.16			4.16		ns
LVTTL, Fast, 4 mA		1.69			2.97			2.97		ns
LVTTL, Fast, 6 mA		1.69			2.60			2.60		ns
LVTTL, Fast, 8 mA		1.69			2.42			2.42		ns
LVTTL, Fast, 12 mA		1.69			2.29			2.29		ns
LVTTL, Fast, 16 mA		1.69			2.25			2.25		ns
LVTTL, Fast, 24 mA		1.69			2.25			2.25		ns
LVC MOS33, QUIETIO, 2 mA		1.69			5.68			5.68		ns
LVC MOS33, QUIETIO, 4 mA		1.69			4.40			4.40		ns
LVC MOS33, QUIETIO, 6 mA		1.69			3.89			3.89		ns
LVC MOS33, QUIETIO, 8 mA		1.69			3.69			3.69		ns
LVC MOS33, QUIETIO, 12 mA		1.69			3.30			3.30		ns
LVC MOS33, QUIETIO, 16 mA		1.69			3.17			3.17		ns
LVC MOS33, QUIETIO, 24 mA		1.69			3.03			3.03		ns
LVC MOS33, Slow, 2 mA		1.69			4.73			4.73		ns
LVC MOS33, Slow, 4 mA		1.69			3.41			3.41		ns
LVC MOS33, Slow, 6 mA		1.69			3.02			3.02		ns
LVC MOS33, Slow, 8 mA		1.69			3.03			3.03		ns
LVC MOS33, Slow, 12 mA		1.69			2.77			2.77		ns
LVC MOS33, Slow, 16 mA		1.69			2.77			2.77		ns
LVC MOS33, Slow, 24 mA		1.69			2.52			2.52		ns
LVC MOS33, Fast, 2 mA		1.69			4.18			4.18		ns
LVC MOS33, Fast, 4 mA		1.69			2.98			2.98		ns
LVC MOS33, Fast, 6 mA		1.69			2.60			2.60		ns

Table 25: IOB Switching Characteristics (Cont'd)

I/O Standard	T <sub>IOP1</sub>			T <sub>IOP</sub>			T <sub>IOTP</sub>			Units
	Speed Grade			Speed Grade			Speed Grade			
	-3	-2	-1L	-3	-2	-1L	-3	-2	-1L	
LVC MOS33, Fast, 8 mA		1.69			2.40			2.40		ns
LVC MOS33, Fast, 12 mA		1.69			2.17			2.17		ns
LVC MOS33, Fast, 16 mA		1.69			2.17			2.17		ns
LVC MOS33, Fast, 24 mA		1.69			2.17			2.17		ns
LVC MOS25, QUIETIO, 2 mA		1.18			5.15			5.15		ns
LVC MOS25, QUIETIO, 4 mA		1.18			4.07			4.07		ns
LVC MOS25, QUIETIO, 6 mA		1.18			3.77			3.77		ns
LVC MOS25, QUIETIO, 8 mA		1.18			3.53			3.53		ns
LVC MOS25, QUIETIO, 12 mA		1.18			3.21			3.21		ns
LVC MOS25, QUIETIO, 16 mA		1.18			3.04			3.04		ns
LVC MOS25, QUIETIO, 24 mA		1.18			2.89			2.89		ns
LVC MOS25, Slow, 2 mA		1.18			4.17			4.17		ns
LVC MOS25, Slow, 4 mA		1.18			3.22			3.22		ns
LVC MOS25, Slow, 6 mA		1.18			3.14			3.14		ns
LVC MOS25, Slow, 8 mA		1.18			2.91			2.91		ns
LVC MOS25, Slow, 12 mA		1.18			2.49			2.49		ns
LVC MOS25, Slow, 16 mA		1.18			2.49			2.49		ns
LVC MOS25, Slow, 24 mA		1.18			2.29			2.29		ns
LVC MOS25, Fast, 2 mA		1.18			3.76			3.76		ns
LVC MOS25, Fast, 4 mA		1.18			2.75			2.75		ns
LVC MOS25, Fast, 6 mA		1.18			2.35			2.35		ns
LVC MOS25, Fast, 8 mA		1.18			2.28			2.28		ns
LVC MOS25, Fast, 12 mA		1.18			2.10			2.10		ns
LVC MOS25, Fast, 16 mA		1.18			2.10			2.10		ns
LVC MOS25, Fast, 24 mA		1.18			2.10			2.10		ns
LVC MOS18, QUIETIO, 2 mA		1.38			6.06			6.06		ns
LVC MOS18, QUIETIO, 4 mA		1.38			4.91			4.91		ns
LVC MOS18, QUIETIO, 6 mA		1.38			4.30			4.30		ns
LVC MOS18, QUIETIO, 8 mA		1.38			4.03			4.03		ns
LVC MOS18, QUIETIO, 12 mA		1.38			3.67			3.67		ns
LVC MOS18, QUIETIO, 16 mA		1.38			3.52			3.52		ns
LVC MOS18, QUIETIO, 24 mA		1.38			3.38			3.38		ns
LVC MOS18, Slow, 2 mA		1.38			4.88			4.88		ns
LVC MOS18, Slow, 4 mA		1.38			4.02			4.02		ns
LVC MOS18, Slow, 6 mA		1.38			3.41			3.41		ns
LVC MOS18, Slow, 8 mA		1.38			2.67			2.67		ns
LVC MOS18, Slow, 12 mA		1.38			2.42			2.42		ns
LVC MOS18, Slow, 16 mA		1.38			2.42			2.42		ns

Table 25: IOB Switching Characteristics (Cont'd)

I/O Standard	T <sub>IOP1</sub>			T <sub>IOP</sub>			T <sub>IOTP</sub>			Units
	Speed Grade			Speed Grade			Speed Grade			
	-3	-2	-1L	-3	-2	-1L	-3	-2	-1L	
LVC MOS18, Slow, 24 mA		1.38			2.37			2.37		ns
LVC MOS18, Fast, 2 mA		1.38			3.96			3.96		ns
LVC MOS18, Fast, 4 mA		1.38			2.87			2.87		ns
LVC MOS18, Fast, 6 mA		1.38			2.26			2.26		ns
LVC MOS18, Fast, 8 mA		1.38			2.22			2.22		ns
LVC MOS18, Fast, 12 mA		1.38			2.14			2.14		ns
LVC MOS18, Fast, 16 mA		1.38			2.14			2.14		ns
LVC MOS18, Fast, 24 mA		1.38			2.14			2.14		ns
LVC MOS18_JEDEC, QUIETIO, 2 mA		1.26			6.02			6.02		ns
LVC MOS18_JEDEC, QUIETIO, 4 mA		1.26			4.91			4.91		ns
LVC MOS18_JEDEC, QUIETIO, 6 mA		1.26			4.29			4.29		ns
LVC MOS18_JEDEC, QUIETIO, 8 mA		1.26			4.02			4.02		ns
LVC MOS18_JEDEC, QUIETIO, 12 mA		1.26			3.67			3.67		ns
LVC MOS18_JEDEC, QUIETIO, 16 mA		1.26			3.52			3.52		ns
LVC MOS18_JEDEC, QUIETIO, 24 mA		1.26			3.38			3.38		ns
LVC MOS18_JEDEC, Slow, 2 mA		1.26			4.87			4.87		ns
LVC MOS18_JEDEC, Slow, 4 mA		1.26			4.00			4.00		ns
LVC MOS18_JEDEC, Slow, 6 mA		1.26			3.41			3.41		ns
LVC MOS18_JEDEC, Slow, 8 mA		1.26			2.67			2.67		ns
LVC MOS18_JEDEC, Slow, 12 mA		1.26			2.42			2.42		ns
LVC MOS18_JEDEC, Slow, 16 mA		1.26			2.42			2.42		ns
LVC MOS18_JEDEC, Slow, 24 mA		1.26			2.37			2.37		ns
LVC MOS18_JEDEC, Fast, 2 mA		1.26			3.95			3.95		ns
LVC MOS18_JEDEC, Fast, 4 mA		1.26			2.86			2.86		ns
LVC MOS18_JEDEC, Fast, 6 mA		1.26			2.25			2.25		ns
LVC MOS18_JEDEC, Fast, 8 mA		1.26			2.21			2.21		ns
LVC MOS18_JEDEC, Fast, 12 mA		1.26			2.14			2.14		ns
LVC MOS18_JEDEC, Fast, 16 mA		1.26			2.14			2.14		ns
LVC MOS18_JEDEC, Fast, 24 mA		1.26			2.14			2.14		ns
LVC MOS15, QUIETIO, 2 mA		1.23			5.62			5.62		ns
LVC MOS15, QUIETIO, 4 mA		1.23			4.81			4.81		ns
LVC MOS15, QUIETIO, 6 mA		1.23			4.32			4.32		ns
LVC MOS15, QUIETIO, 8 mA		1.23			4.16			4.16		ns
LVC MOS15, QUIETIO, 12 mA		1.23			3.89			3.89		ns
LVC MOS15, QUIETIO, 16 mA		1.23			3.69			3.69		ns
LVC MOS15, Slow, 2 mA		1.23			4.48			4.48		ns
LVC MOS15, Slow, 4 mA		1.23			3.78			3.78		ns
LVC MOS15, Slow, 6 mA		1.23			2.71			2.71		ns

Table 25: IOB Switching Characteristics (Cont'd)

I/O Standard	$T_{IOPI}$			$T_{IOOP}$			$T_{IOTP}$			Units
	Speed Grade			Speed Grade			Speed Grade			
	-3	-2	-1L	-3	-2	-1L	-3	-2	-1L	
LVC MOS15, Slow, 8 mA		1.23			2.73			2.73		ns
LVC MOS15, Slow, 12 mA		1.23			2.48			2.48		ns
LVC MOS15, Slow, 16 mA		1.23			2.47			2.47		ns
LVC MOS15, Fast, 2 mA		1.23			3.67			3.67		ns
LVC MOS15, Fast, 4 mA		1.23			2.73			2.73		ns
LVC MOS15, Fast, 6 mA		1.23			2.16			2.16		ns
LVC MOS15, Fast, 8 mA		1.23			2.14			2.14		ns
LVC MOS15, Fast, 12 mA		1.23			2.07			2.07		ns
LVC MOS15, Fast, 16 mA		1.23			2.05			2.05		ns
LVC MOS15_JEDEC, QUIETIO, 2 mA		1.36			5.61			5.61		ns
LVC MOS15_JEDEC, QUIETIO, 4 mA		1.36			4.80			4.80		ns
LVC MOS15_JEDEC, QUIETIO, 6 mA		1.36			4.32			4.32		ns
LVC MOS15_JEDEC, QUIETIO, 8 mA		1.36			4.18			4.18		ns
LVC MOS15_JEDEC, QUIETIO, 12 mA		1.36			3.89			3.89		ns
LVC MOS15_JEDEC, QUIETIO, 16 mA		1.36			3.69			3.69		ns
LVC MOS15_JEDEC, Slow, 2 mA		1.36			4.49			4.49		ns
LVC MOS15_JEDEC, Slow, 4 mA		1.36			3.78			3.78		ns
LVC MOS15_JEDEC, Slow, 6 mA		1.36			2.72			2.72		ns
LVC MOS15_JEDEC, Slow, 8 mA		1.36			2.73			2.73		ns
LVC MOS15_JEDEC, Slow, 12 mA		1.36			2.47			2.47		ns
LVC MOS15_JEDEC, Slow, 16 mA		1.36			2.47			2.47		ns
LVC MOS15_JEDEC, Fast, 2 mA		1.36			3.67			3.67		ns
LVC MOS15_JEDEC, Fast, 4 mA		1.36			2.74			2.74		ns
LVC MOS15_JEDEC, Fast, 6 mA		1.36			2.15			2.15		ns
LVC MOS15_JEDEC, Fast, 8 mA		1.36			2.14			2.14		ns
LVC MOS15_JEDEC, Fast, 12 mA		1.36			2.08			2.08		ns
LVC MOS15_JEDEC, Fast, 16 mA		1.36			2.05			2.05		ns
LVC MOS12, QUIETIO, 2 mA		1.10			6.39			6.39		ns
LVC MOS12, QUIETIO, 4 mA		1.10			5.15			5.15		ns
LVC MOS12, QUIETIO, 6 mA		1.10			4.84			4.84		ns
LVC MOS12, QUIETIO, 8 mA		1.10			4.54			4.54		ns
LVC MOS12, QUIETIO, 12 mA		1.10			4.30			4.30		ns
LVC MOS12, Slow, 2 mA		1.10			5.18			5.18		ns
LVC MOS12, Slow, 4 mA		1.10			3.27			3.27		ns
LVC MOS12, Slow, 6 mA		1.10			3.17			3.17		ns
LVC MOS12, Slow, 8 mA		1.10			2.78			2.78		ns
LVC MOS12, Slow, 12 mA		1.10			2.57			2.57		ns

Table 25: IOB Switching Characteristics (Cont'd)

I/O Standard	T <sub>IOP1</sub>			T <sub>IOP</sub>			T <sub>IOTP</sub>			Units
	Speed Grade			Speed Grade			Speed Grade			
	-3	-2	-1L	-3	-2	-1L	-3	-2	-1L	
LVC MOS12, Fast, 2 mA		1.10			3.84			3.84		ns
LVC MOS12, Fast, 4 mA		1.10			2.81			2.81		ns
LVC MOS12, Fast, 6 mA		1.10			2.25			2.25		ns
LVC MOS12, Fast, 8 mA		1.10			2.16			2.16		ns
LVC MOS12, Fast, 12 mA		1.10			2.08			2.08		ns
LVC MOS12_JEDEC, QUIETIO, 2 mA		1.67			6.39			6.39		ns
LVC MOS12_JEDEC, QUIETIO, 4 mA		1.67			5.15			5.15		ns
LVC MOS12_JEDEC, QUIETIO, 6 mA		1.67			4.83			4.83		ns
LVC MOS12_JEDEC, QUIETIO, 8 mA		1.67			4.52			4.52		ns
LVC MOS12_JEDEC, QUIETIO, 12 mA		1.67			4.30			4.30		ns
LVC MOS12_JEDEC, Slow, 2 mA		1.67			5.19			5.19		ns
LVC MOS12_JEDEC, Slow, 4 mA		1.67			3.27			3.27		ns
LVC MOS12_JEDEC, Slow, 6 mA		1.67			3.17			3.17		ns
LVC MOS12_JEDEC, Slow, 8 mA		1.67			2.78			2.78		ns
LVC MOS12_JEDEC, Slow, 12 mA		1.67			2.57			2.57		ns
LVC MOS12_JEDEC, Fast, 2 mA		1.67			3.85			3.85		ns
LVC MOS12_JEDEC, Fast, 4 mA		1.67			2.81			2.81		ns
LVC MOS12_JEDEC, Fast, 6 mA		1.67			2.25			2.25		ns
LVC MOS12_JEDEC, Fast, 8 mA		1.67			2.16			2.16		ns
LVC MOS12_JEDEC, Fast, 12 mA		1.67			2.08			2.08		ns

Table 26: IOB 3-state ON Output Switching Characteristics (T<sub>IOTPHZ</sub>)

Symbol	Description	Speed Grade			Units
		-3	-2	-1L	
T <sub>IOTPHZ</sub>	T input to Pad high-impedance		1.59		ns

## I/O Standard Adjustment Measurement Methodology

### Input Delay Measurements

Table 27 shows the test setup parameters used for measuring input delay.

Table 27: Input Delay Measurement Methodology

Description	I/O Standard Attribute	$V_L^{(1)}$	$V_H^{(1)}$	$V_{MEAS}^{(3,4)}$	$V_{REF}^{(2,4)}$
LVTTTL (Low-Voltage Transistor-Transistor Logic)	LVTTTL	0	3.0	1.4	–
LVC MOS (Low-Voltage CMOS), 3.3V	LVC MOS33	0	3.3	1.65	–
LVC MOS, 2.5V	LVC MOS25	0	2.5	1.25	–
LVC MOS, 1.8V	LVC MOS18	0	1.8	0.9	–
LVC MOS, 1.5V	LVC MOS15	0	1.5	0.75	–
LVC MOS, 1.2V	LVC MOS12	0	1.2	0.6	–
PCI (Peripheral Component Interface), 33 MHz, 3.3V	PCI33_3	Per PCI Specification			–
HSTL (High-Speed Transceiver Logic), Class I & II	HSTL_I, HSTL_II	$V_{REF} - 0.5$	$V_{REF} + 0.5$	$V_{REF}$	0.75
HSTL, Class III	HSTL_III	$V_{REF} - 0.5$	$V_{REF} + 0.5$	$V_{REF}$	0.90
HSTL, Class I & II, 1.8V	HSTL_I_18, HSTL_II_18	$V_{REF} - 0.5$	$V_{REF} + 0.5$	$V_{REF}$	0.90
HSTL, Class III 1.8V	HSTL_III_18	$V_{REF} - 0.5$	$V_{REF} + 0.5$	$V_{REF}$	1.08
SSTL (Stub Terminated Transceiver Logic), Class I & II, 3.3V	SSTL3_I, SSTL3_II	$V_{REF} - 0.75$	$V_{REF} + 0.75$	$V_{REF}$	1.5
SSTL, Class I & II, 2.5V	SSTL2_I, SSTL2_II	$V_{REF} - 0.75$	$V_{REF} + 0.75$	$V_{REF}$	1.25
SSTL, Class I & II, 1.8V	SSTL18_I, SSTL18_II	$V_{REF} - 0.5$	$V_{REF} + 0.5$	$V_{REF}$	0.90
SSTL, Class II, 1.5V	SSTL15_II	$V_{REF} - 0.2$	$V_{REF} + 0.2$	$V_{REF}$	0.75
LVDS (Low-Voltage Differential Signaling), 2.5V & 3.3V	LVDS_25, LVDS_33	$1.25 - 0.125$	$1.25 + 0.125$	0 <sup>(5)</sup>	
LVPECL (Low-Voltage Positive Emitter-Coupled Logic), 2.5V & 3.3V	LVPECL_25, LVPECL_33	$1.2 - 0.3$	$1.2 - 0.3$	0 <sup>(5)</sup>	
BLVDS (Bus LVDS), 2.5V	BLVDS_25	$1.3 - 0.125$	$1.3 + 0.125$	0 <sup>(5)</sup>	
Mini-LVDS, 2.5V & 3.3V	MINI_LVDS_25, MINI_LVDS_33	$1.2 - 0.125$	$1.2 + 0.125$	0 <sup>(5)</sup>	
RS DS (Reduced Swing Differential Signaling), 2.5V & 3.3V	RS DS_25, RS DS_33	$1.2 - 0.1$	$1.2 + 0.1$	0 <sup>(5)</sup>	
TMDS (Transition Minimized Differential Signaling), 3.3V	TMDS_33	$3.0 - 0.1$	$3.0 + 0.1$	0 <sup>(5)</sup>	
PPDS (Point-to-Point Differential Signaling), 2.5V & 3.3V	PPDS_25, PPDS_33	$1.25 - 0.1$	$1.25 + 0.1$	0 <sup>(5)</sup>	

**Notes:**

1. Input waveform switches between  $V_L$  and  $V_H$ .
2. Measurements are made at typical, minimum, and maximum  $V_{REF}$  values. Reported delays reflect worst case of these measurements.  $V_{REF}$  values listed are typical.
3. Input voltage level from which measurement starts.
4. This is an input voltage reference that bears no relation to the  $V_{REF} / V_{MEAS}$  parameters found in IBIS models and/or noted in Figure 6.
5. The value given is the differential input voltage.

### Output Delay Measurements

Output delays are measured using a Tektronix P6245 TDS500/600 probe (< 1 pF) across approximately 4" of FR4 microstrip trace. Standard termination was used for all testing. The propagation delay of the 4" trace is characterized separately and subtracted from the final measurement, and is therefore not included in the generalized test setups shown in Figure 6 and Figure 7.

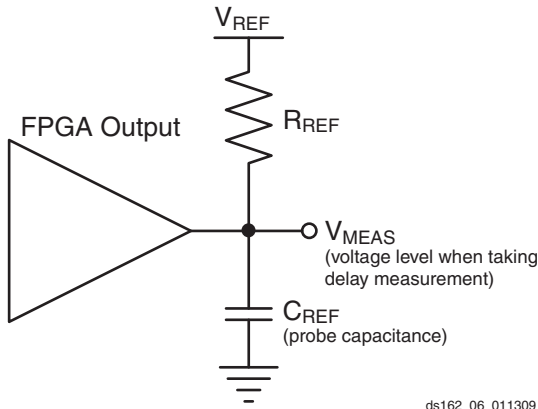
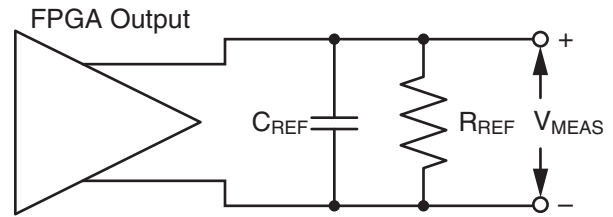

Figure 6: Single-Ended Test Setup



ds162\_07\_011309

Figure 7: Differential Test Setup

Measurements and test conditions are reflected in the IBIS models except where the IBIS format precludes it. Parameters  $V_{REF}$ ,  $R_{REF}$ ,  $C_{REF}$ , and  $V_{MEAS}$  fully describe the test conditions for each I/O standard. The most accurate prediction of propagation delay in any given application can be obtained through IBIS simulation, using the following method:

1. Simulate the output driver of choice into the generalized test setup, using values from Table 28.
2. Record the time to  $V_{MEAS}$ .
3. Simulate the output driver of choice into the actual PCB trace and load, using the appropriate IBIS model or capacitance value to represent the load.
4. Record the time to  $V_{MEAS}$ .
5. Compare the results of steps 2 and 4. The increase or decrease in delay yields the actual propagation delay of the PCB trace.

Table 28: Output Delay Measurement Methodology

Description	I/O Standard Attribute	$R_{REF}$ ( $\Omega$ )	$C_{REF}^{(1)}$ (pF)	$V_{MEAS}$ (V)	$V_{REF}$ (V)
LVTTTL (Low-Voltage Transistor-Transistor Logic)	LVTTTL (all)	1M	0	1.4	0
LVC MOS (Low-Voltage CMOS), 3.3V	LVC MOS33	1M	0	1.65	0
LVC MOS, 2.5V	LVC MOS25	1M	0	1.25	0
LVC MOS, 1.8V	LVC MOS18	1M	0	0.9	0
LVC MOS, 1.5V	LVC MOS15	1M	0	0.75	0
LVC MOS, 1.2V	LVC MOS12	1M	0	0.75	0
PCI (Peripheral Component Interface), 33 MHz, 3.3V	PCI33_3 (rising edge)	25	10 <sup>(2)</sup>	0.94	0
	PCI33_3 (falling edge)	25	10 <sup>(2)</sup>	2.03	3.3
HSTL (High-Speed Transceiver Logic), Class I	HSTL_I	50	0	$V_{REF}$	0.75
HSTL, Class II	HSTL_II	25	0	$V_{REF}$	0.75
HSTL, Class III	HSTL_III	50	0	0.9	1.5
HSTL, Class I, 1.8V	HSTL_I_18	50	0	$V_{REF}$	0.9
HSTL, Class II, 1.8V	HSTL_II_18	25	0	$V_{REF}$	0.9
HSTL, Class III, 1.8V	HSTL_III_18	50	0	1.1	1.8
SSTL (Stub Series Terminated Logic), Class I, 1.8V	SSTL18_I	50	0	$V_{REF}$	0.9
SSTL, Class II, 1.8V	SSTL18_II	25	0	$V_{REF}$	0.9
SSTL, Class I, 2.5V	SSTL2_I	50	0	$V_{REF}$	1.25

Table 28: Output Delay Measurement Methodology (Cont'd)

Description	I/O Standard Attribute	R <sub>REF</sub> (Ω)	C <sub>REF</sub> <sup>(1)</sup> (pF)	V <sub>MEAS</sub> (V)	V <sub>REF</sub> (V)
SSTL, Class II, 2.5V	SSTL2_II	25	0	V <sub>REF</sub>	1.25
SSTL, Class II, 1.5V	SSTL15_II	25	0	V <sub>REF</sub>	0.75
LVDS (Low-Voltage Differential Signaling), 2.5V & 3.3V	LVDS_25, LVDS_33	100	0	0 <sup>(3)</sup>	1.2
BLVDS (Bus LVDS), 2.5V	BLVDS_25	100	0	0 <sup>(3)</sup>	0
Mini-LVDS, 2.5V & 3.3V	MINI_LVDS_25, MINI_LVDS_33	100	0	0 <sup>(3)</sup>	
RSDS (Reduced Swing Differential Signaling), 2.5V & 3.3V	RSDS_25, RSDS_33	100	0	0 <sup>(3)</sup>	
TMDS (Transition Minimized Differential Signaling), 3.3V	TMDS_33	100	0	0 <sup>(3)</sup>	
PPDS (Point-to-Point Differential Signaling, 2.5V & 3.3V)	PPDS_25, PPDS_33	100	0	0 <sup>(3)</sup>	

**Notes:**

1. C<sub>REF</sub> is the capacitance of the probe, nominally 0 pF.
2. Per PCI specifications.
3. The value given is the differential input voltage.

## Input/Output Logic Switching Characteristics

Table 29: ILOGIC2 Switching Characteristics

Symbol	Description	Speed Grade			Units
		-3	-2	-1L	
<b>Setup/Hold</b>					
T <sub>ICE0CK</sub> /T <sub>ICKCE0</sub>	CE0 pin Setup/Hold with respect to CLK		1.04 -0.58		ns
T <sub>ISRCK</sub> /T <sub>ICKSR</sub>	SR pin Setup/Hold with respect to CLK		1.09 -0.51		ns
T <sub>IDOCK</sub> /T <sub>IOCKD</sub>	D pin Setup/Hold with respect to CLK without Delay		1.73 -1.38		ns
T <sub>IDOCKD</sub> /T <sub>IOCKDD</sub>	DDLY pin Setup/Hold with respect to CLK (using IODELAY2)		0.51 -0.25		ns
<b>Combinatorial</b>					
T <sub>IDI</sub>	D pin to O pin propagation delay, no Delay		1.77		ns
T <sub>IDID</sub>	DDLY pin to O pin propagation delay (using IODELAY2)		0.53		ns
<b>Sequential Delays</b>					
T <sub>IDLO</sub>	D pin to Q1 pin using flip-flop as a latch without Delay		2.80		ns
T <sub>IDLOD</sub>	DDLY pin to Q1 pin using flip-flop as a latch (using IODELAY2)		1.58		ns
T <sub>ICKQ</sub>	CLK to Q outputs		1.38		ns
T <sub>RQ</sub>	SR pin to OQ/TQ out		2.54		ns
T <sub>GSRQ</sub>	Global Set/Reset to Q outputs				ns
<b>Set/Reset</b>					
T <sub>RPW</sub>	Minimum Pulse Width, SR inputs				ns, Min



Table 30: OLOGIC2 Switching Characteristics

Symbol	Description	Speed Grade			Units
		-3	-2	-1L	
<b>Setup/Hold</b>					
$T_{ODCK}/T_{OCKD}$	D1/D2 pins Setup/Hold with respect to CLK		0.96 -0.26		ns
$T_{OOCECK}/T_{OCKOCE}$	OCE pin Setup/Hold with respect to CLK		0.47 -0.22		ns
$T_{OSRCK}/T_{OCKSR}$	SR pin Setup/Hold with respect to CLK		0.91 -0.47		ns
$T_{OTCK}/T_{OCKT}$	T1/T2 pins Setup/Hold with respect to CLK		0.72 -0.18		ns
$T_{OTCECK}/T_{OCKTCE}$	TCE pin Setup/Hold with respect to CLK		0.39 -0.13		ns
<b>Combinatorial</b>					
$T_{DOQ}$	D1 to OQ out or T1 to TQ out				ns
<b>Sequential Delays</b>					
$T_{OCKQ}$	CLK to OQ/TQ out		0.81		ns
$T_{RQ}$	SR pin to OQ/TQ out		2.54		ns
$T_{GSRQ}$	Global Set/Reset to Q outputs				ns
<b>Set/Reset</b>					
$T_{RPW}$	Minimum Pulse Width, SR inputs				ns, Min

### Input Serializer/Deserializer Switching Characteristics

Table 31: ISERDES2 Switching Characteristics

Symbol	Description	Speed Grade			Units
		-3	-2	-1L	
<b>Setup/Hold for Control Lines</b>					
$T_{ISCK\_BITSLLIP}/T_{ISCKC\_BITSLLIP}$	BITSLIP pin Setup/Hold with respect to CLKDIV		0.31 -0.14		ns
$T_{ISCK\_CE}/T_{ISCKC\_CE}$	CE pin Setup/Hold with respect to CLK		1.16 -0.71		ns
<b>Setup/Hold for Data Lines</b>					
$T_{ISDCK\_D}/T_{ISCKD\_D}$	D pin Setup/Hold with respect to CLK		1.60 -1.00		ns
$T_{ISDCK\_DDLY}/T_{ISCKD\_DDLY}$	DDLY pin Setup/Hold with respect to CLK (using IODELAY2)		-0.37 0.56		ns
$T_{ISDCK\_D\_DDR}/T_{ISCKD\_D\_DDR}$	D pin Setup/Hold with respect to CLK at DDR mode		1.61 -1.00		ns
$T_{ISDCK\_DDLY\_DDR}/T_{ISCKD\_DDLY\_DDR}$	D pin Setup/Hold with respect to CLK at DDR mode (using IODELAY2)		-0.44 0.69		ns
<b>Sequential Delays</b>					
$T_{ISCKO\_Q}$	CLKDIV to out at Q pin		2.02		ns
<b>Propagation Delays</b>					
$T_{ISDO\_DO}$	D input to DO output pin		2.06		ns

**Notes:**

- Recorded at 0 tap value.

## Output Serializer/Deserializer Switching Characteristics

Table 32: OSERDES2 Switching Characteristics

Symbol	Description	Speed Grade			Units
		-3	-2	-1L	
<b>Setup/Hold</b>					
$T_{OSDCK\_D}/T_{OSCKD\_D}$	D input Setup/Hold with respect to CLKDIV		0.19 0.01		ns
$T_{OSDCK\_T}/T_{OSCKD\_T}^{(1)}$	T input Setup/Hold with respect to CLK		0.23 -0.02		ns
$T_{OSDCK\_T2}/T_{OSCKD\_T2}^{(1)}$	T input Setup/Hold with respect to CLKDIV				ns
$T_{OSCK\_OCE}/T_{OSCKC\_OCE}$	OCE input Setup/Hold with respect to CLK		0.24 -0.16		ns
$T_{OSCK\_S}$	SR (Reset) input Setup with respect to CLKDIV				ns
$T_{OSCK\_TCE}/T_{OSCKC\_TCE}$	TCE input Setup/Hold with respect to CLK		0.27 -0.15		ns
<b>Sequential Delays</b>					
$T_{OSCKO\_OQ}$	Clock to out from CLK to OQ		1.89		ns
$T_{OSCKO\_TQ}$	Clock to out from CLK to TQ		1.91		ns
<b>Combinatorial</b>					
$T_{OSDO\_TTQ}$	T input to TQ Out				ns
$T_{OSCO\_OQ}$	Asynchronous Reset to OQ		1.89		ns
$T_{OSCO\_TQ}$	Asynchronous Reset to TQ		1.91		ns

**Notes:**

1.  $T_{OSDCK\_T2}$  and  $T_{OSCKD\_T2}$  are reported as  $T_{OSDCK\_T}/T_{OSCKD\_T}$  in TRACE report.

## Input/Output Delay Switching Characteristics

Table 33: IODELAY2 Switching Characteristics

Symbol	Description	Speed Grade			Units
		-3	-2	-1L	
$T_{IODCCK\_CAL} / T_{IODCKC\_CAL}$	CAL pin Setup/Hold with respect to CK		0.48 -0.22		ns
$T_{IODCCK\_CE} / T_{IODCKC\_CE}$	CE pin Setup/Hold with respect to CK		0.25 -0.02		ns
$T_{IODCCK\_INC} / T_{IODCKC\_INC}$	INC pin Setup/Hold with respect to CK		0.18 0.06		ns
$T_{IODCCK\_RST} / T_{IODCKC\_RST}$	RST pin Setup/Hold with respect to CK		0.22 -0.01		ns
$T_{IODDO\_T}$	TSCONTROL delay to MUXE/MUXF switching and through IODELAY2	Note 1	Note 1	Note 1	
$T_{IODDO\_IDATAIN}$	Propagation delay through IODELAY2	Note 1	Note 1	Note 1	
$T_{IODDO\_ODATAIN}$	Propagation delay through IODELAY2	Note 1	Note 1	Note 1	

**Notes:**

1. Delay depends on IODELAY2 tap setting. See TRACE report for actual values.

## CLB Switching Characteristics (SLICEM Only)

Table 34: CLB Switching Characteristics (SLICEM Only)

Symbol	Description	Speed Grade			Units
		-3	-2	-1L	
<b>Combinatorial Delays</b>					
T <sub>ILO</sub>	An – Dn LUT address to A to D outputs		0.48		ns, Max
T <sub>ILO</sub>	An – Dn LUT address through F7AMUX/F7BMUX to AMUX/CMUX		0.77		ns, Max
T <sub>OPAB</sub>	An – Dn LUT address through F7AMUX or F7BMUX and F8MUX to BMUX		0.79		ns, Max
T <sub>ITO</sub>	An – Dn inputs to A – D Q outputs		1.36		ns, Max
T <sub>TITO_LOGIC</sub>	An – Dn inputs to A – D Q outputs (Latch as Logic)		1.36		ns, Max
T <sub>OPCYA</sub>	An input to COUT output		0.84		ns, Max
T <sub>OPCYB</sub>	Bn input to COUT output		0.81		ns, Max
T <sub>OPCYC</sub>	Cn input to COUT output		0.62		ns, Max
T <sub>OPCYD</sub>	Dn input to COUT output		0.58		ns, Max
T <sub>AXCY</sub>	AX input to COUT output		0.41		ns, Max
T <sub>BXCY</sub>	BX input to COUT output		0.30		ns, Max
T <sub>CXCY</sub>	CX input to COUT output		0.16		ns, Max
T <sub>DXCY</sub>	DX input to COUT output		0.14		ns, Max
T <sub>BYP</sub>	CIN input to COUT output		0.10		ns, Max
T <sub>CINA</sub>	CIN input to AMUX output		0.41		ns, Max
T <sub>CINB</sub>	CIN input to BMUX output		0.50		ns, Max
T <sub>CINC</sub>	CIN input to CMUX output		0.49		ns, Max
T <sub>CIND</sub>	CIN input to DMUX output		0.56		ns, Max
<b>Sequential Delays</b>					
T <sub>CKO</sub>	Clock to AQ – DQ outputs		0.63		ns, Max
<b>Setup and Hold Times of CLB Flip-Flops Before/After Clock CLK</b>					
T <sub>DICK</sub> /T <sub>CKDI</sub>	A – D input to CLK on A – D flip-flops		0.79 0.46		ns, Min
T <sub>CECK</sub> /T <sub>CKCE</sub>	CE input to CLK on A – D flip-flops		0.59 –0.15		ns, Min
T <sub>SRCK</sub> /T <sub>CKSR</sub>	SR input to CLK on A – D flip-flops		0.55 –0.28		ns, Min
T <sub>CINCK</sub> /T <sub>CKCIN</sub>	CIN input to CLK on A – D flip-flops		0.62 0.33		ns, Min
<b>Set/Reset</b>					
T <sub>SRMIN</sub>	SR input minimum pulse width				ns, Min
T <sub>RQ</sub>	Delay from SR input to AQ – DQ flip-flops		2.54		ns, Max
T <sub>CEO</sub>	Delay from CE input to AQ – DQ flip-flops		1.15		ns, Max
F <sub>TOG</sub>	Toggle frequency (for export control)				MHz

**Notes:**

1. A Zero “0” Hold Time listing indicates no hold time or a negative hold time. Negative values can not be guaranteed “best-case”, but if a “0” is listed, there is no positive hold time.
2. These items are of interest for Carry Chain applications.

### CLB Distributed RAM Switching Characteristics (SLICEM Only)

Table 35: CLB Distributed RAM Switching Characteristics (SLICEM Only)

Symbol	Description	Speed Grade			Units
		-3	-2	-1L	
<b>Sequential Delays</b>					
$T_{SHCKO}$	Clock to A – D outputs		2.06		ns, Max
<b>Setup and Hold Times Before/After Clock CLK</b>					
$T_{DS}/T_{DH}$	A – D inputs to CLK		1.04 0.37		ns, Min
$T_{AS}/T_{AH}$	Address An inputs to clock		1.21 0.67		ns, Min
$T_{WS}/T_{WH}$	WE input to clock		0.59 -0.15		ns, Min
$T_{CECK}/T_{CKCE}$	CE input to CLK		0.59 -0.15		ns, Min
<b>Clock CLK</b>					
$T_{MPW}$	Minimum pulse width				ns, Min
$T_{MCP}$	Minimum clock period				ns, Min

**Notes:**

1. A Zero “0” Hold Time listing indicates no hold time or a negative hold time. Negative values cannot be guaranteed “best-case”, but if a “0” is listed, there is no positive hold time.
2.  $T_{SHCKO}$  also represents the CLK to XMUX output. Refer to TRACE report for the CLK to XMUX path.

### CLB Shift Register Switching Characteristics (SLICEM Only)

Table 36: CLB Shift Register Switching Characteristics

Symbol	Description	Speed Grade			Units
		-3	-2	-1L	
<b>Sequential Delays</b>					
$T_{REG}$	Clock to A – D outputs		2.34		ns, Max
$T_{REG\_MUX}$	Clock to AMUX – DMUX output				ns, Max
$T_{REG\_M31}$	Clock to DMUX output via M31 output				ns, Max
<b>Setup and Hold Times Before/After Clock CLK</b>					
$T_{WS}/T_{WH}$	WE input to CLK		0.59 -0.15		ns, Min
$T_{CECK}/T_{CKCE}$	CE input to CLK		0.59 -0.15		ns, Min
$T_{DS}/T_{DH}$	A – D inputs to CLK		1.04 0.37		ns, Min
<b>Clock CLK</b>					
$T_{MPW}$	Minimum pulse width				ns, Min

**Notes:**

1. A Zero “0” Hold Time listing indicates no hold time or a negative hold time. Negative values cannot be guaranteed “best-case”, but if a “0” is listed, there is no positive hold time.

## Block RAM Switching Characteristics

Table 37: Block RAM Switching Characteristics

Symbol	Description	Speed Grade			Units
		-3	-2	-1L	
<b>Block RAM Clock to Out Delays</b>					
$T_{RCKO\_DO}$	Clock CLK to DOUT output (without output register) <sup>(1)</sup>		3.00		ns, Max
$T_{RCKO\_DO\_REG}$	Clock CLK to DOUT output (with output register) <sup>(2)</sup>		1.60		ns, Max
<b>Setup and Hold Times Before/After Clock CLK</b>					
$T_{RCKC\_ADDR}/T_{RCKC\_ADDR}$	ADDR inputs <sup>(3)</sup>		0.40 0.10		ns, Min
$T_{RDCK\_DI}/T_{RCKD\_DI}$	DIN inputs <sup>(4)</sup>		0.30 0.10		ns, Min
$T_{RCKC\_EN}/T_{RCKC\_EN}$	Block RAM Enable (EN) input		0.20 0.05		ns, Min
$T_{RCKC\_REGCE}/T_{RCKC\_REGCE}$	CE input of output register		0.20 0.08		ns, Min
$T_{RCKC\_WE}/T_{RCKC\_WE}$	Write Enable (WE) input		0.20 0.10		ns, Min
<b>Maximum Frequency</b>					
$F_{MAX}$	Block RAM in all modes		260		MHz

**Notes:**

- $T_{RCKO\_DO}$  includes  $T_{RCKO\_DOA}$  and  $T_{RCKO\_DOPA}$  as well as the B port equivalent timing parameters.
- $T_{RCKO\_DO\_REG}$  includes  $T_{RCKO\_DOA\_REG}$  and  $T_{RCKO\_DOPA\_REG}$  as well as the B port equivalent timing parameters.
- The ADDR setup and hold must be met when EN is asserted (even when WE is deasserted). Otherwise, block RAM data corruption is possible.
- $T_{RCKO\_DI}$  includes both A and B inputs as well as the parity inputs of A and B.

## DSP48A1 Switching Characteristics

Table 38: DSP48A1 Switching Characteristics

Symbol	Description	Pre-adder	Multiplier	Post-adder	Speed Grade			Units
					-3	-2	-1L	
<b>Setup and Hold Times of Data/Control Pins to the Input Register Clock</b>								
$T_{DSPDCK\_A\_A1REG}/T_{DSPCKD\_A\_A1REG}$	A input to A1 register CLK	N/A	N/A	N/A		0.03 0.09		ns
$T_{DSPDCK\_D\_B1REG}/T_{DSPCKD\_D\_B1REG}$	D input to B1 register CLK	Yes	N/A	N/A		1.99 -0.07		ns
$T_{DSPDCK\_C\_CREG}/T_{DSPCKD\_C\_CREG}$	C input to C register CLK	N/A	N/A	N/A		-0.03 0.09		ns
$T_{DSPDCK\_D\_DREG}/T_{DSPCKD\_D\_DREG}$	D input to D register CLK	N/A	N/A	N/A		-0.06 0.12		ns
$T_{DSPDCK\_OPMODE\_B1REG}/T_{DSPCKD\_OPMODE\_B1REG}$	OPMODE input to B1 register CLK	Yes	N/A	N/A		2.01 0.00		ns
$T_{DSPDCK\_OPMODE\_OPMODEREG}/T_{DSPCKD\_OPMODE\_OPMODEREG}$	OPMODE input to OPMODE register CLK	N/A	N/A	N/A		0.28 0.12		ns

Table 38: DSP48A1 Switching Characteristics (Cont'd)

Symbol	Description	Pre-adder	Multiplier	Post-adder	Speed Grade			Units
					-3	-2	-1L	
<b>Setup and Hold Times of Data Pins to the Pipeline Register Clock</b>								
$T_{DSPDCK\_A\_MREG}/$ $T_{DSPCKD\_A\_MREG}$	A input to M register CLK	N/A	Yes	N/A		2.88 -0.40		ns
$T_{DSPDCK\_B\_MREG}/$ $T_{DSPCKD\_B\_MREG}$	B input to M register CLK	Yes	Yes	N/A		4.93 -0.68		ns
		No	Yes	N/A		3.22 -0.57		ns
$T_{DSPDCK\_D\_MREG}/$ $T_{DSPCKD\_D\_MREG}$	D input to M register CLK	Yes	Yes	N/A		4.82 -0.56		ns
$T_{DSPDCK\_OPMODE\_MREG}/$ $T_{DSPCKD\_OPMODE\_MREG}$	OPMODE to M register CLK	Yes	Yes	N/A		4.84 -0.43		ns
		No	Yes	N/A		3.02 -0.43		ns
<b>Setup and Hold Times of Data/Control Pins to the Output Register Clock</b>								
$T_{DSPDCK\_A\_PREG}/$ $T_{DSPCKD\_A\_PREG}$	A input to P register CLK	N/A	Yes	Yes		5.38 -0.76		ns
$T_{DSPDCK\_B\_PREG}/$ $T_{DSPCKD\_B\_PREG}$	B input to P register CLK	Yes	Yes	Yes		7.43 -1.05		ns
		No	Yes	Yes		5.72 -0.93		ns
$T_{DSPDCK\_C\_PREG}/$ $T_{DSPCKD\_C\_PREG}$	C input to P register CLK	N/A	N/A	Yes		2.30 -0.23		ns
$T_{DSPDCK\_D\_PREG}/$ $T_{DSPCKD\_D\_PREG}$	D input to P register CLK	Yes	Yes	Yes		7.32 -0.92		ns
$T_{DSPDCK\_OPMODE\_PREG}/$ $T_{DSPCKD\_OPMODE\_PREG}$	OPMODE input to P register CLK	Yes	Yes	Yes		7.43 -0.43		ns
		No	Yes	Yes		5.42 -0.43		ns
		No	No	Yes		2.46 -0.39		ns
<b>Clock to Out from Output Register Clock to Output Pin</b>								
$T_{DSPCKO\_P\_PREG}$	CLK (PREG) to P output	N/A	N/A	N/A		1.32		ns
<b>Clock to Out from Pipeline Register Clock to Output Pins</b>								
$T_{DSPCKO\_P\_MREG}$	CLK (MREG) to P output	N/A	N/A	Yes		4.33		ns
<b>Clock to Out from Input Register Clock to Output Pins</b>								
$T_{DSPCKO\_P\_A1REG}$	CLK (A1REG) to P output	N/A	Yes	Yes		6.65		ns
$T_{DSPCKO\_P\_B1REG}$	CLK (B1REG) to P output	N/A	Yes	Yes		6.64		ns
$T_{DSPCKO\_P\_CREG}$	CLK (CREG) to P output	N/A	N/A	Yes		3.68		ns
$T_{DSPCKO\_P\_DREG}$	CLK (DREG) to P output	Yes	Yes	Yes		8.99		ns

Table 38: DSP48A1 Switching Characteristics (Cont'd)

Symbol	Description	Pre-adder	Multiplier	Post-adder	Speed Grade			Units
					-3	-2	-1L	
<b>Combinatorial Delays from Input Pins to Output Pins</b>								
T <sub>DSPDO_A_P</sub> T <sub>DSPDO_B_P</sub>	A or B input to P output	N/A	No	Yes		3.68		ns
		N/A	Yes	No		5.10		ns
		N/A	Yes	Yes		6.65		ns
T <sub>DSPDO_B_P</sub>	B input to P output	Yes	No	No		3.84		ns
		Yes	Yes	No		6.81		ns
		Yes	Yes	Yes		8.41		ns
T <sub>DSPDO_C_P</sub>	C input to P output	N/A	N/A	Yes		3.28		ns
T <sub>DSPDO_D_P</sub>	D input to P output	Yes	Yes	Yes		8.30		ns
T <sub>DSPDO_OPMODE_P</sub>	OPMODE input to P output	Yes	Yes	Yes		8.27		ns
		No	Yes	Yes		6.50		ns
		No	No	Yes		3.68		ns
<b>Maximum Frequency</b>								
F <sub>MAX</sub>	All registers used	Yes	Yes	Yes		250		MHz

**Notes:**

1. A Yes signifies that the component is in the path. A No signifies that the component is being bypassed. N/A signifies not applicable because no path exists.

Table 39: Device DNA Interface Port Switching Characteristics

Symbol	Description	Speed Grade			Units
		-3	-2	-1L	
T <sub>DNASSU</sub>	Setup time on SHIFT before the rising edge of CLK	1			ns, min
T <sub>DNASH</sub>	Hold time on SHIFT after the rising edge of CLK	0.5			ns, min
T <sub>DNADSU</sub>	Setup time on DIN before the rising edge of CLK	1			ns, min
T <sub>DNADH</sub>	Hold time on DIN after the rising edge of CLK	0.5			ns, min
T <sub>DNARSU</sub>	Setup time on READ before the rising edge of CLK	5			ns, min
		10,000			ns, max
T <sub>DNARH</sub>	Hold time on READ after the rising edge of CLK	0			ns, min
T <sub>DNADCKO</sub>	Clock-to-output delay on DOUT after rising edge of CLK	0.5			ns, min
		1.5			ns, max
T <sub>DNACLKF</sub>	CLK frequency	33			MHz, max
T <sub>DNACLKL</sub>	CLK High time	10			ns, min
T <sub>DNACLKH</sub>	CLK Low time	10			ns, min

**Notes:**

1. The minimum READ pulse width is 5 ns, the maximum READ pulse width is 10 ms.

Table 40: Suspend Mode Switching Characteristics

Symbol	Description	Speed Grade			Units
		-3	-2	-1L	
<b>Entering Suspend Mode</b>					
$T_{\text{SUSPENDHIGH\_AWAKE}}$	Rising edge of SUSPEND pin to falling edge of AWAKE pin without glitch filter (suspend_filter:No)	7 (typical)			ns
$T_{\text{SUSPENDFILTER}}$	Adjustment to SUSPEND pin rising edge parameters when glitch filter enabled (suspend_filter:Yes)	300 (typical)			ns
$T_{\text{SUSPEND\_GWE}}$	Rising edge of SUSPEND pin until FPGA output pins drive their defined SUSPEND constraint behavior	10 (typical)			ns
$T_{\text{SUSPEND\_GTS}}$	Rising edge of SUSPEND pin to write-protect lock on all writable clocked elements	<5 (typical)			ns
$T_{\text{SUSPEND\_DISABLE}}$	Rising edge of the SUSPEND pin to FPGA input pins and interconnect disabled	800 (typical)			ns
<b>Exiting Suspend Mode</b>					
$T_{\text{SUSPENDLOW\_AWAKE}}$	Falling edge of the SUSPEND pin to rising edge of the AWAKE pin. Does not include DCM lock time.	7 to 39 (typical)			$\mu\text{s}$
$T_{\text{SUSPEND\_ENABLE}}$	Falling edge of the SUSPEND pin to FPGA input pins and interconnect re-enabled	7 to 39 (typical)			$\mu\text{s}$
$T_{\text{AWAKE\_GWE1}}$	Rising edge of the AWAKE pin until write-protect lock released on all writable clocked elements, using sw_clk:InternalClock and sw_gwe_cycle:1.	67 (typical)			ns
$T_{\text{AWAKE\_GWE512}}$	Rising edge of the AWAKE pin until write-protect lock released on all writable clocked elements, using sw_clk:InternalClock and sw_gwe_cycle:512.	14 (typical)			$\mu\text{s}$
$T_{\text{AWAKE\_GTS1}}$	Rising edge of the AWAKE pin until outputs return to the behavior described in the FPGA application, using sw_clk:InternalClock and sw_gts_cycle:1.	57 (typical)			ns
$T_{\text{AWAKE\_GTS512}}$	Rising edge of the AWAKE pin until outputs return to the behavior described in the FPGA application, using sw_clk:InternalClock and sw_gts_cycle:512.	14 (typical)			$\mu\text{s}$
$T_{\text{SCP\_AWAKE}}$	Rising edge of SCP pins to rising edge of AWAKE pin	7 to 39 (typical)			$\mu\text{s}$

**Notes:**

1. All values are specified as typical at nominal conditions.



## Configuration Switching Characteristics

Table 41: Configuration Switching Characteristics

Symbol	Description	Speed Grade			Units
		-3	-2	-1L	
<b>Power-up Timing Characteristics</b>					
$T_{PL}$	PROGRAM_B Latency		1.5		ms, Max
$T_{POR}$	Power-on-Reset		30		ms, Max
$T_{PROGRAM}$	PROGRAM_B Pulse Width		500		ns, Min
<b>Slave Serial Mode Programming Switching</b>					
$T_{DCCK}/T_{CCKD}$	DIN Setup/Hold, slave mode		6.0/1.0		ns, Min
$T_{CCO}$	CCLK to DOUT		12		ns, Max
$F_{MSCCK}$	Slave mode external CCLK				MHz
<b>Slave SelectMAP Mode Programming Switching</b>					
$T_{SMDCCK}/T_{SMCCKD}$	SelectMAP Data Setup/Hold		6.0/1.0		ns, Min
$T_{SMCSCCK}/T_{SMCCKCS}$	CSI_B Setup/Hold		6.0/0.0		ns, Min
$T_{SMCCKW}/T_{SMWCCK}$	RDWR_B Setup/Hold		15.0/1.0		ns, Min
$T_{SMCKCSO}$	CSO_B clock to out		14		ns, Min
$T_{SMCO}$	CCLK to DATA out in readback		13	N/A	ns, Max
$T_{SMCKBY}$	CCLK to BUSY out in readback		12	N/A	ns, Max
$F_{SMCCK}$	Maximum Frequency with respect to nominal CCLK				MHz, Max
$F_{RBCCK}$	Maximum Readback Frequency with respect to nominal CCLK			N/A	MHz, Max
<b>Boundary-Scan Port Timing Specifications</b>					
$T_{TAPTCK}$	TMS and TDI Setup time before TCK		9		ns, Min
$T_{TCKTAP}$	TMS and TDI Hold time after TCK		0		ns, Min
$T_{TCKTDO}$	TCK falling edge to TDO output valid		8		ns, Max
$F_{TCK}$	Maximum configuration TCK clock frequency		25		MHz, Max
$F_{TCKB}$	Maximum boundary-scan TCK clock frequency		25		MHz, Max
<b>BPI Master Flash Mode Programming Switching</b>					
$T_{BPICCO}^{(3)}$	A[25:0], FCS_B, FOE_B, FWE_B, LDC outputs valid after CCLK falling edge		15		ns
$T_{BPIICCK}$	Master BPI CCLK (output) delay				ns, Min/Max
$T_{BPIDCC}/T_{BPICCD}$	Setup/Hold on D[15:0] data input pins				ns
$T_{INITADDR}$	Minimum period of initial A[25:0] address cycles		3		CCLK cycles
<b>SPI Master Flash Mode Programming Switching</b>					
$T_{SPIDCC}/T_{SPIDCCD}$	DIN, MISO0, MISO1, MISO2, MISO3, Setup/Hold before/after the rising CCLK edge		5.0/1.0		ns
$T_{SPIICCK}$	Master SPI CCLK (output) delay				ns, Min/Max
$T_{SPICCM}$	MOSI clock to out				ns
$T_{SPICCFC}$	CSO_B clock to out		14		ns

Table 41: Configuration Switching Characteristics (Cont'd)

Symbol	Description	Speed Grade			Units
		-3	-2	-1L	
<b>CCLK Output (Master Modes)</b>					
$T_{MCCKL}$	Master CCLK clock duty cycle Low	45	45		%, Min
$T_{MCCKH}$	Master CCLK clock duty cycle High	45	45		%, Min
$F_{MCCK}$	Maximum Frequency, master mode with respect to nominal CCLK				MHz, Max
$F_{MCCKTOL}$	Frequency Tolerance, master mode with respect to nominal CCLK	±50	±50	±50	%
<b>CCLK Input (Slave Modes)</b>					
$T_{SCCKL}$	Slave CCLK clock minimum Low time		5		ns, Min
$T_{SCCKH}$	Slave CCLK clock minimum High time		5		ns, Min

**Notes:**

1. Maximum frequency and setup/hold timing parameters are for 3.3V and 2.5V configuration voltages.
2. To support longer delays in configuration, use the design solutions described in [Spartan-6 FPGA Configuration User Guide](#).
3. Only during configuration, the last edge is determined by a weak pull-up/pull-down resistor in the I/O.

## Clock Buffers and Networks

Table 42: Global Clock Switching Characteristics

Symbol	Description	Devices	Speed Grade			Units
			-3	-2	-1L	
$T_{GSI}$	S pin Setup to I0/I1 inputs	All		0.56		ns
$T_{GIO}$	BUFGMUX delay from I0/I1 to O	XC6SLX4				ns
		XC6SLX9				ns
		XC6SLX16		0.42		ns
		XC6SLX25				ns
		XC6SLX25T			N/A	ns
		XC6SLX45		0.42		ns
		XC6SLX45T		0.42	N/A	ns
		XC6SLX75				ns
		XC6SLX75T			N/A	ns
		XC6SLX100				ns
		XC6SLX100T			N/A	ns
		XC6SLX150				ns
		XC6SLX150T			N/A	ns
<b>Maximum Frequency</b>						
$F_{MAX}$	Global clock tree (BUFG)	XC6SLX4				MHz
		XC6SLX9				MHz
		XC6SLX16		375		MHz
		XC6SLX25				MHz
		XC6SLX25T			N/A	MHz
		XC6SLX45		375		MHz
		XC6SLX45T		375	N/A	MHz
		XC6SLX75				MHz
		XC6SLX75T			N/A	MHz
		XC6SLX100				MHz
		XC6SLX100T			N/A	MHz
		XC6SLX150				MHz
		XC6SLX150T			N/A	MHz

Table 43: Input/Output Clock Switching Characteristics (BUFIO2)

Symbol	Description	Speed Grade			Units
		-3	-2	-1L	
$T_{BUFCKO\_O}$	Clock to out delay from I to O		1.5		ns
<b>Maximum Frequency</b>					
$F_{MAX}$	I/O clock tree (BUFIO2)				MHz

## PLL Switching Characteristics

Table 44: PLL Specification

Symbol	Description	Device	Speed Grade			Units
			-3	-2	-1L	
F <sub>INMAX</sub>	Maximum Input Clock Frequency from I/O Clock	All		450		MHz
	Maximum Input Clock Frequency from Global Clock	All		375		MHz
F <sub>INMIN</sub>	Minimum Input Clock Frequency	All		19		MHz
F <sub>INJITTER</sub>	Maximum Input Clock Period Jitter	All	<20% of clock input period or 1 ns Max			
F <sub>INDUTY</sub>	Allowable Input Duty Cycle: 19—199 MHz	All	25/75			%
	Allowable Input Duty Cycle: 200—299 MHz	All	35/65			%
	Allowable Input Duty Cycle: > 300 MHz	All	45/55			%
F <sub>VCOMIN</sub>	Minimum PLL VCO Frequency	All				MHz
F <sub>VCOMAX</sub>	Maximum PLL VCO Frequency	All				MHz
F <sub>BANDWIDTH</sub>	Low PLL Bandwidth at Typical <sup>(1)</sup>	All				MHz
	High PLL Bandwidth at Typical <sup>(1)</sup>	All				MHz
T <sub>STAPHAOFFSET</sub>	Static Phase Offset of the PLL Outputs	All				ps
T <sub>OUTJITTER</sub>	PLL Output Jitter <sup>(2)</sup>	All	Note 1			
T <sub>OUTDUTY</sub>	PLL Output Clock Duty Cycle Precision <sup>(3)</sup>	All				ps
T <sub>LOCKMAX</sub>	PLL Maximum Lock Time <sup>(4)</sup>	All				μs
F <sub>OUTMAX</sub>	PLL Maximum Output Frequency for BUFGMUX	XC6SLX4				MHz
		XC6SLX9				MHz
		XC6SLX16		375		MHz
		XC6SLX25				MHz
		XC6SLX25T			N/A	MHz
		XC6SLX45		375		MHz
		XC6SLX45T		375	N/A	MHz
		XC6SLX75				MHz
		XC6SLX75T			N/A	MHz
		XC6SLX100				MHz
		XC6SLX100T			N/A	MHz
		XC6SLX150				MHz
		XC6SLX150T			N/A	MHz

Table 44: PLL Specification (Cont'd)

Symbol	Description	Device	Speed Grade			Units
			-3	-2	-1L	
F <sub>OUTMAX</sub>	PLL Maximum Output Frequency for BUFPLL	XC6SLX4				MHz
		XC6SLX9				MHz
		XC6SLX16				MHz
		XC6SLX25				MHz
		XC6SLX25T			N/A	MHz
		XC6SLX45				MHz
		XC6SLX45T			N/A	MHz
		XC6SLX75				MHz
		XC6SLX75T			N/A	MHz
		XC6SLX100				MHz
		XC6SLX100T			N/A	MHz
		XC6SLX150				MHz
		XC6SLX150T			N/A	MHz
		F <sub>OUTMIN</sub>	PLL Minimum Output Frequency <sup>(5)</sup>	All		
T <sub>EXTFDVAR</sub>	External Clock Feedback Variation	All	< 20% of clock input period or 1 ns Max			
RST <sub>MINPULSE</sub>	Minimum Reset Pulse Width	All				ns
F <sub>PFDMAX</sub>	Maximum Frequency at the Phase Frequency Detector	All				MHz
F <sub>PFDMIN</sub>	Minimum Frequency at the Phase Frequency Detector	All				MHz
T <sub>FBDELAY</sub>	Maximum Delay in the Feedback Path	All	3 ns Max or one CLKIN cycle			

**Notes:**

1. The PLL does not filter typical spread spectrum input clocks because they are usually far below the bandwidth filter frequencies.
2. Values for this parameter are available in the Architecture Wizard.
3. Includes global clock buffer.
4. The LOCK signal must be sampled after T<sub>LOCKMAX</sub>. The LOCK signal is invalid after configuration or reset until the T<sub>LOCKMAX</sub> time has expired.
5. Calculated as F<sub>VCO</sub>/128 assuming output duty cycle is 50%.

## DCM Switching Characteristics

Table 45: Operating Frequency Ranges and Conditions for the Delay-Locked Loop (DLL)<sup>(1)</sup>

Symbol	Description	Speed Grade						Units
		-3		-2		-1L		
		Min	Max	Min	Max	Min	Max	
<b>Input Frequency Ranges</b>								
CLKIN_FREQ_DLL	Frequency of the CLKIN clock input. Also described as $F_{CLKIN}$ .			5 <sup>(2)</sup>	250 <sup>(3)</sup>			MHz
<b>Input Pulse Requirements</b>								
CLKIN_PULSE	CLKIN pulse width as a percentage of the CLKIN period for CLKIN_FREQ_DLL < 150 MHz			40	60			%
	CLKIN pulse width as a percentage of the CLKIN period for CLKIN_FREQ_DLL > 150 MHz			45	55			%
<b>Input Clock Jitter Tolerance and Delay Path Variation<sup>(4)</sup></b>								
CLKIN_CYC_JITT_DLL_LF	Cycle-to-cycle jitter at the CLKIN input for CLKIN_FREQ_DLL < 150 MHz				±300			ps
CLKIN_CYC_JITT_DLL_HF	Cycle-to-cycle jitter at the CLKIN input for CLKIN_FREQ_DLL > 150 MHz.				±150			ps
CLKIN_PER_JITT_DLL	Period jitter at the CLKIN input.				±1			ns
CLKFB_DELAY_VAR_EXT	Allowable variation of the off-chip feedback delay from the DCM output to the CLKFB input.				±1			ns

**Notes:**

- DLL specifications apply when using any of the DLL outputs: CLK0, CLK90, CLK180, CLK270, CLK2X, CLK2X180, or CLKDV.
- When operating independently of the DLL, the DFS supports lower CLKIN\_FREQ\_DLL frequencies. See Table 47.
- To support double the maximum effective CLKIN\_FREQ\_DLL limit, set the CLKIN\_DIVIDE\_BY\_2 attribute to TRUE. This attribute divides the incoming clock period by two as it enters the DCM. The CLK2X output reproduces the clock frequency provided on the CLKIN\_FREQ\_DLL input.
- CLKIN\_FREQ\_DLL input jitter beyond these limits can cause the DCM to lose LOCK, indicated by the LOCKED output deasserting. The user must then reset the DCM.
- When using both DCMs in a CMT, both DCMs must be LOCKED.

Table 46: Switching Characteristics for the Delay-Locked Loop (DLL) <sup>(1)</sup>

Symbol	Description	Speed Grade						Units
		-3		-2		-1L		
		Min	Max	Min	Max	Min	Max	
<b>Output Frequency Ranges</b>								
CLKOUT_FREQ_CLK0	Frequency for the CLK0 and CLK180 outputs.			5	250			MHz
CLKOUT_FREQ_CLK90	Frequency for the CLK90 and CLK270 outputs.			5	200			MHz
CLKOUT_FREQ_2X	Frequency for the CLK2X and CLK2X180 outputs.			10	334			MHz
CLKOUT_FREQ_DV	Frequency for the CLKDV output.			0.3125	166			MHz
<b>Output Clock Jitter<sup>(2,3,4)</sup></b>								
CLKOUT_PER_JITT_0	Period jitter at the CLK0 output.	–		–	±100	–		ps
CLKOUT_PER_JITT_90	Period jitter at the CLK90 output.	–		–	±150	–		ps
CLKOUT_PER_JITT_180	Period jitter at the CLK180 output.	–		–	±150	–		ps
CLKOUT_PER_JITT_270	Period jitter at the CLK270 output.	–		–	±150	–		ps

Table 46: Switching Characteristics for the Delay-Locked Loop (DLL) <sup>(1)</sup> (Cont'd)

Symbol	Description	Speed Grade						Units
		-3		-2		-1L		
		Min	Max	Min	Max	Min	Max	
CLKOUT_PER_JITT_2X	Period jitter at the CLK2X and CLK2X180 outputs.	–		–	±[0.5% of CLKIN period + 100]	–		ps
CLKOUT_PER_JITT_DV1	Period jitter at the CLKDV output when performing integer division.	–		–	±150	–		ps
CLKOUT_PER_JITT_DV2	Period jitter at the CLKDV output when performing non-integer division.	–		–	±[0.5% of CLKIN period + 100]	–		ps
<b>Duty Cycle<sup>(4)</sup></b>								
CLKOUT_DUTY_CYCLE_DLL	Duty cycle variation for the CLK0, CLK90, CLK180, CLK270, CLK2X, CLK2X180, and CLKDV outputs, including the BUFGMUX and clock tree duty-cycle distortion.	–		–	±[1% of CLKIN period + 350]	–		ps
<b>Phase Alignment<sup>(4)</sup></b>								
CLKIN_CLKFB_PHASE	Phase offset between the CLKIN and CLKFB inputs.	–		–	±150	–		ps
CLKOUT_PHASE_DLL	Phase offset between DLL outputs for CLK0 to CLK2X (not CLK2X180).	–		–	±[1% of CLKIN period + 100]	–		ps
	Phase offset between DLL outputs for all others.	–		–		–		ps
LOCK_DLL <sup>(3)</sup>	When using the DLL alone: The time from deassertion at the DCM's reset input to the rising transition at its LOCKED output. When the DCM is locked, the CLKIN and CLKFB signals are in phase. 5 MHz < CLKIN_FREQ_DLL < 15 MHz.			–	5	–		ms
	When using the DLL alone: The time from deassertion at the DCM's reset input to the rising transition at its LOCKED output. When the DCM is locked, the CLKIN and CLKFB signals are in phase. CLKIN_FREQ_DLL > 15 MHz			–	0.60	–		ms
<b>Delay Lines</b>								
DCM_DELAY_STEP <sup>(5)</sup>	Finest delay resolution, averaged over all steps.			10	40			ps

**Notes:**

1. The values in this table are based on the operating conditions described in Table 2 and Table 45.
2. Indicates the maximum amount of output jitter that the DCM adds to the jitter on the CLKIN input.
3. For optimal jitter tolerance and faster LOCK time, use the CLKIN\_PERIOD attribute.
4. Some jitter and duty-cycle specifications include 1% of input clock period or 0.01 UI. For example, this data sheet specifies a maximum jitter of ±(1% of CLKIN period + 150 ps). Assuming that the CLKIN frequency is 100 MHz, the equivalent CLKIN period is 10 ns. Since 1% of 10 ns is 0.1 ns or 100 ps, the maximum jitter is ±(100 ps + 150 ps) = ±250 ps.
5. A typical delay step size is 23 ps.

Table 47: Recommended Operating Conditions for the Digital Frequency Synthesizer (DFS) (1)

Symbol	Description	Speed Grade						Units
		-3		-2		-1L		
		Min	Max	Min	Max	Min	Max	
<b>Input Frequency Ranges(2)</b>								
CLKIN_FREQ_FX	Frequency for the CLKIN input. Also described as $F_{CLKIN}$ .			0.5	333			MHz
<b>Input Clock Jitter Tolerance(3)</b>								
CLKIN_CYC_JITT_FX_LF	Cycle-to-cycle jitter at the CLKIN input, based on CLKFX output frequency: $F_{CLKFX} < 150$ MHz.	–		–	±300	–		ps
CLKIN_CYC_JITT_FX_HF	Cycle-to-cycle jitter at the CLKIN input, based on CLKFX output frequency: $F_{CLKFX} > 150$ MHz.	–		–	±150	–		ps
CLKIN_PER_JITT_FX	Period jitter at the CLKIN input.	–		–	±1	–		ns

**Notes:**

1. DFS specifications apply when using either of the DFS outputs (CLKFX, CLKFXDV, or CLKFX180).
2. When using both DFS and DLL outputs on the same DCM, follow the more restrictive CLKIN\_FREQ\_DLL specifications in Table 45.
3. CLKIN input jitter beyond these limits can cause the DCM to lose LOCK.

Table 48: Switching Characteristics for the Digital Frequency Synthesizer (DFS) (1)

Symbol	Description	Speed Grade						Units
		-3		-2		-1L		
		Min	Max	Min	Max	Min	Max	
<b>Output Frequency Ranges</b>								
CLKOUT_FREQ_FX	Frequency for the CLKFX and CLKFX180 outputs			5	320			MHz
CLKOUT_FREQ_FXDV	Frequency for the CLKFXDV output			0.15625	160			MHz
<b>Output Clock Jitter(2,3)</b>								
CLKOUT_PER_JITT_FX	Period jitter at the CLKFX, CLKFX180, and CLKFXDV outputs. When $CLKIN < 20$ MHz			Use the Jitter Calculator				ps
	Period jitter at the CLKFX, CLKFX180, and CLKFXDV outputs. When $CLKIN > 20$ MHz			±(1% of CLKFX period + 100)	±(1% of CLKFX period + 200)			ps
<b>Duty Cycle(4,5)</b>								
CLKOUT_DUTY_CYCLE_FX	Duty cycle precision for the CLKFX, CLKFX180, and CLKFXDV outputs, including the BUFGMUX and clock tree duty-cycle distortion		–		±(1% of CLKFX period + 350)		–	ps
<b>Phase Alignment(5)</b>								
CLKOUT_PHASE_FX	Phase offset between the DFS CLKFX or CLKFXDV output and the DLL CLK0 output when both the DFS and DLL are used		–		±200		–	ps
CLKOUT_PHASE_FX180	Phase offset between the DFS CLKFX180 output and the DLL CLK0 output when both the DFS and DLL are used		–		±(1% of CLKFX period + 200)		–	ps



Table 48: Switching Characteristics for the Digital Frequency Synthesizer (DFS) <sup>(1)</sup> (Cont'd)

Symbol	Description	Speed Grade						Units
		-3		-2		-1L		
		Min	Max	Min	Max	Min	Max	
<b>LOCKED Time</b>								
LOCK_FX <sup>(2)</sup>	When 5 MHz < FCLKIN < 15 MHz, the time from deassertion at the DCM's reset input to the rising transition at its LOCKED output. The DFS asserts LOCKED when the CLKFX, CLKFX180, and CLKFXDV signals are valid. When using both the DLL and the DFS, use the longer locking time.	–		–	5	–		ms
	When FCLKIN > 15 MHz, the time from deassertion at the DCM's reset input to the rising transition at its LOCKED output. The DFS asserts LOCKED when the CLKFX, CLKFX180, and CLKFXDV signals are valid. When using both the DLL and the DFS, use the longer locking time.	–		–	0.45	–		ms

**Notes:**

1. The values in this table are based on the operating conditions described in Table 2 and Table 47.
2. For optimal jitter tolerance and a faster LOCK time, use the CLKIN\_PERIOD attribute.
3. Maximum output jitter is characterized using a reasonable noise environment (40 SSOs and 25% CLB switching). Output jitter strongly depends on the environment, including the number of SSOs, the output drive strength, CLB utilization, CLB switching activities, switching frequency, power supply, and PCB design. The actual maximum output jitter depends on the system application.
4. The CLKFX, CLKFXDV, and CLKFX180 outputs have a duty cycle of approximately 50%.
5. Some duty cycle and alignment specifications include a percentage of the CLKFX output period. For example, this data sheet specifies a maximum CLKFX jitter of ±(1% of CLKFX period + 200 ps). Assuming that the CLKFX output frequency is 100 MHz, the equivalent CLKFX period is 10 ns, and 1% of 10 ns is 0.1 ns or 100 ps. Accordingly, the maximum jitter is ±(100 ps + 200 ps) = ±300 ps.

Table 49: Recommended Operating Conditions for the Phase-Shift Clock in Variable Phase Mode

Symbol	Description	Speed Grade						Units
		-3		-2		-1L		
		Min	Max	Min	Max	Min	Max	
<b>Operating Frequency Ranges</b>								
PSCLK_FREQ	Frequency for the PSCLK input.			1	167			MHz
<b>Input Pulse Requirements</b>								
PSCLK_PULSE	PSCLK pulse width as a percentage of the PSCLK period.			40	60			%

Table 50: Switching Characteristics for the Phase-Shift Clock in Variable Phase Mode<sup>(1)</sup>

Symbol	Description	Amount of Phase Shift	Units
<b>Phase Shifting Range</b>			
MAX_STEPS <sup>(2)</sup>	When CLKIN < 60 MHz, the maximum allowed number of DCM_DELAY_STEP steps for a given CLKIN clock period, where T = CLKIN clock period in ns. When using CLKIN_DIVIDE_BY_2 = TRUE, double the clock-effective clock period.	±(INTEGER(10 x (TCLKIN – 3 ns)))	steps
	When CLKIN ≥ 60 MHz, the maximum allowed number of DCM_DELAY_STEP steps for a given CLKIN clock period, where T = CLKIN clock period in ns. When using CLKIN_DIVIDE_BY_2 = TRUE, double the clock-effective clock period.	±(INTEGER(15 x (TCLKIN – 3 ns)))	steps
FINE_SHIFT_RANGE_MIN	Minimum guaranteed delay for variable phase shifting.	±(MAX_STEPS x DCM_DELAY_STEP_MIN)	ns
FINE_SHIFT_RANGE_MAX	Maximum guaranteed delay for variable phase shifting	±(MAX_STEPS x DCM_DELAY_STEP_MAX)	ns

**Notes:**

1. The values in this table are based on the operating conditions described in Table 45 and Table 49.
2. The maximum variable phase shift range, MAX\_STEPS, is only valid when the DCM has no initial fixed-phase shifting, that is, the PHASE\_SHIFT attribute is set to 0.
3. The DCM\_DELAY\_STEP values are provided at the end of Table 46.

Table 51: Miscellaneous DCM Timing Parameters<sup>(1)</sup>

Symbol	Description	Min	Max	Units
DCM_RST_PW_MIN	Minimum duration of a RST pulse width	3	–	CLKIN cycles

**Notes:**

1. This limit only applies to applications that use the DCM DLL outputs (CLK0, CLK90, CLK180, CLK270, CLK2X, CLK2X180, and CLKDV). The DCM DFS outputs (CLKFX, CLKFXDV, CLKFX180) are unaffected.

Table 52: Frequency Synthesis

Attribute	Min	Max
CLKFX_MULTIPLY	2	32
CLKFX_DIVIDE	1	32

Table 53: DCM Switching Characteristics

Symbol	Description	Speed Grade			Units
		-3	-2	-1L	
T <sub>DMCCK_PSEN</sub> /T <sub>DMCKC_PSEN</sub>	PSEN Setup/Hold		0.03/ 0.00		ns
T <sub>DMCCK_PSINCDEC</sub> /T <sub>DMCKC_PSINCDEC</sub>	PSINCDEC Setup/Hold		0.03/ 0.00		ns
T <sub>DMCKO_PSDONE</sub>	Clock to out of PSDONE		0.05		ns

## Spartan-6 Device Pin-to-Pin Output Parameter Guidelines

All devices are 100% functionally tested. The representative values for typical pin locations and normal clock loading are listed in Table 54. Values are expressed in nanoseconds unless otherwise noted.

Table 54: Global Clock Input to Output Delay Without DCM or PLL

Symbol	Description	Device	Speed Grade			Units
			-3	-2	-1L	
LVCMOS25 Global Clock Input to Output Delay using Output Flip-Flop, 12mA, Fast Slew Rate, <i>without</i> DCM or PLL						
T <sub>ICKOF</sub>	Global Clock and OUTFF <i>without</i> DCM or PLL	XC6SLX4				ns
		XC6SLX9				ns
		XC6SLX16				ns
		XC6SLX25				ns
		XC6SLX25T			N/A	ns
		XC6SLX45				ns
		XC6SLX45T			N/A	ns
		XC6SLX75				ns
		XC6SLX75T			N/A	ns
		XC6SLX100				ns
		XC6SLX100T			N/A	ns
		XC6SLX150				ns
		XC6SLX150T			N/A	ns

**Notes:**

- Listed above are representative values where one global clock input drives one vertical clock line in each accessible column, and where all accessible IOB and CLB flip-flops are clocked by the global clock net.

Table 55: Global Clock Input to Output Delay With DCM in System-Synchronous Mode

Symbol	Description	Device	Speed Grade			Units
			-3	-2	-1L	
LVCMOS25 Global Clock Input to Output Delay using Output Flip-Flop, 12mA, Fast Slew Rate, <i>with</i> DCM in System-Synchronous Mode.						
T <sub>ICKOFDCM</sub>	Global Clock and OUTFF <i>with</i> DCM	XC6SLX4				ns
		XC6SLX9				ns
		XC6SLX16				ns
		XC6SLX25				ns
		XC6SLX25T			N/A	ns
		XC6SLX45				ns
		XC6SLX45T			N/A	ns
		XC6SLX75				ns
		XC6SLX75T			N/A	ns
		XC6SLX100				ns
		XC6SLX100T			N/A	ns
		XC6SLX150				ns
		XC6SLX150T			N/A	ns

**Notes:**

- Listed above are representative values where one global clock input drives one vertical clock line in each accessible column, and where all accessible IOB and CLB flip-flops are clocked by the global clock net.
- DCM output jitter is already included in the timing calculation.

**Table 56: Global Clock Input to Output Delay With DCM in Source-Synchronous Mode**

Symbol	Description	Device	Speed Grade			Units
			-3	-2	-1L	
LVCMOS25 Global Clock Input to Output Delay using Output Flip-Flop, 12mA, Fast Slew Rate, <i>with</i> DCM in Source-Synchronous Mode.						
T <sub>ICKOFDCM_0</sub>	Global Clock and OUTFF <i>with</i> DCM	XC6SLX4				ns
		XC6SLX9				ns
		XC6SLX16				ns
		XC6SLX25				ns
		XC6SLX25T			N/A	ns
		XC6SLX45				ns
		XC6SLX45T			N/A	ns
		XC6SLX75				ns
		XC6SLX75T			N/A	ns
		XC6SLX100				ns
		XC6SLX100T			N/A	ns
		XC6SLX150				ns
		XC6SLX150T			N/A	ns

**Notes:**

1. Listed above are representative values where one global clock input drives one vertical clock line in each accessible column, and where all accessible IOB and CLB flip-flops are clocked by the global clock net.
2. DCM output jitter is already included in the timing calculation.

**Table 57: Global Clock Input to Output Delay With PLL in System-Synchronous Mode**

Symbol	Description	Device	Speed Grade			Units
			-3	-2	-1L	
LVCMOS25 Global Clock Input to Output Delay using Output Flip-Flop, 12mA, Fast Slew Rate, <i>with</i> PLL in System-Synchronous Mode.						
T <sub>ICKOFPLL</sub>	Global Clock and OUTFF <i>with</i> PLL	XC6SLX4				ns
		XC6SLX9				ns
		XC6SLX16				ns
		XC6SLX25				ns
		XC6SLX25T			N/A	ns
		XC6SLX45				ns
		XC6SLX45T			N/A	ns
		XC6SLX75				ns
		XC6SLX75T			N/A	ns
		XC6SLX100				ns
		XC6SLX100T			N/A	ns
		XC6SLX150				ns
		XC6SLX150T			N/A	ns

**Notes:**

1. Listed above are representative values where one global clock input drives one vertical clock line in each accessible column, and where all accessible IOB and CLB flip-flops are clocked by the global clock net.
2. PLL output jitter is included in the timing calculation.

Table 58: Global Clock Input to Output Delay With PLL in Source-Synchronous Mode

Symbol	Description	Device	Speed Grade			Units
			-3	-2	-1L	
LVCMOS25 Global Clock Input to Output Delay using Output Flip-Flop, 12mA, Fast Slew Rate, with PLL in Source-Synchronous Mode.						
T <sub>ICKOFFLL_0</sub>	Global Clock and OUTFF with PLL	XC6SLX4				ns
		XC6SLX9				ns
		XC6SLX16				ns
		XC6SLX25				ns
		XC6SLX25T			N/A	ns
		XC6SLX45				ns
		XC6SLX45T			N/A	ns
		XC6SLX75				ns
		XC6SLX75T			N/A	ns
		XC6SLX100				ns
		XC6SLX100T			N/A	ns
		XC6SLX150				ns
		XC6SLX150T			N/A	ns

Notes:

1. Listed above are representative values where one global clock input drives one vertical clock line in each accessible column, and where all accessible IOB and CLB flip-flops are clocked by the global clock net.
2. PLL output jitter is included in the timing calculation.

Table 59: Global Clock Input to Output Delay With DCM and PLL in System-Synchronous Mode

Symbol	Description	Device	Speed Grade			Units
			-3	-2	-1L	
LVCMOS25 Global Clock Input to Output Delay using Output Flip-Flop, 12mA, Fast Slew Rate, with DCM and PLL in System-Synchronous Mode.						
T <sub>ICKOFFDCM_PLL</sub>	Global Clock and OUTFF with DCM and PLL	XC6SLX4				ns
		XC6SLX9				ns
		XC6SLX16				ns
		XC6SLX25				ns
		XC6SLX25T			N/A	ns
		XC6SLX45				ns
		XC6SLX45T			N/A	ns
		XC6SLX75				ns
		XC6SLX75T			N/A	ns
		XC6SLX100				ns
		XC6SLX100T			N/A	ns
		XC6SLX150				ns
		XC6SLX150T			N/A	ns

Notes:

1. Listed above are representative values where one global clock input drives one vertical clock line in each accessible column, and where all accessible IOB and CLB flip-flops are clocked by the global clock net.
2. DCM and PLL output jitter are already included in the timing calculation.

Table 60: Global Clock Input to Output Delay With DCM and PLL in Source-Synchronous Mode

Symbol	Description	Device	Speed Grade			Units
			-3	-2	-1L	
LVCMOS25 Global Clock Input to Output Delay using Output Flip-Flop, 12mA, Fast Slew Rate, <i>with</i> DCM and PLL in Source-Synchronous Mode.						
T <sub>ICKOFDCM0_PLL</sub>	Global Clock and OUTFF with DCM and PLL	XC6SLX4				ns
		XC6SLX9				ns
		XC6SLX16				ns
		XC6SLX25				ns
		XC6SLX25T			N/A	ns
		XC6SLX45				ns
		XC6SLX45T			N/A	ns
		XC6SLX75				ns
		XC6SLX75T			N/A	ns
		XC6SLX100				ns
		XC6SLX100T			N/A	ns
		XC6SLX150				ns
		XC6SLX150T			N/A	ns

**Notes:**

1. Listed above are representative values where one global clock input drives one vertical clock line in each accessible column, and where all accessible IOB and CLB flip-flops are clocked by the global clock net.
2. DCM and PLL output jitter are already included in the timing calculation.

## Spartan-6 Device Pin-to-Pin Input Parameter Guidelines

All devices are 100% functionally tested. The representative values for typical pin locations and normal clock loading are listed in Table 61. Values are expressed in nanoseconds unless otherwise noted.

Table 61: Global Clock Setup and Hold Without DCM or PLL

Symbol	Description	Device	Speed Grade			Units
			-3	-2	-1L	
<b>Input Setup and Hold Time Relative to Global Clock Input Signal for LVC MOS25 Standard.<sup>(1)</sup></b>						
T <sub>PSFD</sub> / T <sub>PHFD</sub>	Full Delay (Legacy Delay or Default Delay) Global Clock and IFF <sup>(2)</sup> without DCM or PLL	XC6SLX4				ns
		XC6SLX9				ns
		XC6SLX16				ns
		XC6SLX25				ns
		XC6SLX25T			N/A	ns
		XC6SLX45				ns
		XC6SLX45T			N/A	ns
		XC6SLX75				ns
		XC6SLX75T			N/A	ns
		XC6SLX100				ns
		XC6SLX100T			N/A	ns
		XC6SLX150				ns
		XC6SLX150T			N/A	ns

**Notes:**

1. Setup and Hold times are measured over worst case conditions (process, voltage, temperature). Setup time is measured relative to the Global Clock input signal using the slowest process, highest temperature, and lowest voltage. Hold time is measured relative to the Global Clock input signal using the fastest process, lowest temperature, and highest voltage.
2. IFF = Input Flip-Flop or Latch
3. A Zero "0" Hold Time listing indicates no hold time or a negative hold time. Negative values can not be guaranteed "best-case", but if a "0" is listed, there is no positive hold time.



Table 62: Global Clock Setup and Hold With DCM in System-Synchronous Mode

Symbol	Description	Device	Speed Grade			Units
			-3	-2	-1L	
<b>Input Setup and Hold Time Relative to Global Clock Input Signal for LVC MOS25 Standard.<sup>(1)</sup></b>						
T <sub>PSDCM</sub> / T <sub>PHDCM</sub>	No Delay Global Clock and IFF <sup>(2)</sup> with DCM in System-Synchronous Mode	XC6SLX4				ns
		XC6SLX9				ns
		XC6SLX16				ns
		XC6SLX25				ns
		XC6SLX25T			N/A	ns
		XC6SLX45				ns
		XC6SLX45T			N/A	ns
		XC6SLX75				ns
		XC6SLX75T			N/A	ns
		XC6SLX100				ns
		XC6SLX100T			N/A	ns
		XC6SLX150				ns
		XC6SLX150T			N/A	ns

**Notes:**

1. Setup and Hold times are measured over worst case conditions (process, voltage, temperature). Setup time is measured relative to the Global Clock input signal using the slowest process, highest temperature, and lowest voltage. Hold time is measured relative to the Global Clock input signal using the fastest process, lowest temperature, and highest voltage. These measurements include DCM CLK0 jitter.
2. IFF = Input Flip-Flop or Latch
3. Use IBIS to determine any duty-cycle distortion incurred using various standards.

Table 63: Global Clock Setup and Hold With DCM in Source-Synchronous Mode

Symbol	Description	Device	Speed Grade			Units
			-3	-2	-1L	
<b>Input Setup and Hold Time Relative to Global Clock Input Signal for LVC MOS25 Standard.<sup>(1)</sup></b>						
T <sub>PSDCM0</sub> / T <sub>PHDCM0</sub>	No Delay Global Clock and IFF <sup>(2)</sup> with DCM in Source-Synchronous Mode	XC6SLX4				ns
		XC6SLX9				ns
		XC6SLX16				ns
		XC6SLX25				ns
		XC6SLX25T			N/A	ns
		XC6SLX45				ns
		XC6SLX45T			N/A	ns
		XC6SLX75				ns
		XC6SLX75T			N/A	ns
		XC6SLX100				ns
		XC6SLX100T			N/A	ns
		XC6SLX150				ns
		XC6SLX150T			N/A	ns

**Notes:**

1. Setup and Hold times are measured over worst case conditions (process, voltage, temperature). Setup time is measured relative to the Global Clock input signal using the slowest process, highest temperature, and lowest voltage. Hold time is measured relative to the Global Clock input signal using the fastest process, lowest temperature, and highest voltage. These measurements include DCM CLK0 jitter.
2. IFF = Input Flip-Flop or Latch
3. Use IBIS to determine any duty-cycle distortion incurred using various standards.

Table 64: Global Clock Setup and Hold With PLL in System-Synchronous Mode

Symbol	Description	Device	Speed Grade			Units
			-3	-2	-1L	
<b>Input Setup and Hold Time Relative to Global Clock Input Signal for LVC MOS25 Standard.<sup>(1)</sup></b>						
T <sub>PSPLL</sub> / T <sub>PHPLL</sub>	No Delay Global Clock and IFF <sup>(2)</sup> with PLL in System-Synchronous Mode	XC6SLX4				ns
		XC6SLX9				ns
		XC6SLX16				ns
		XC6SLX25				ns
		XC6SLX25T			N/A	ns
		XC6SLX45				ns
		XC6SLX45T			N/A	ns
		XC6SLX75				ns
		XC6SLX75T			N/A	ns
		XC6SLX100				ns
		XC6SLX100T			N/A	ns
		XC6SLX150				ns
		XC6SLX150T			N/A	ns

**Notes:**

1. Setup and Hold times are measured over worst case conditions (process, voltage, temperature). Setup time is measured relative to the Global Clock input signal using the slowest process, highest temperature, and lowest voltage. Hold time is measured relative to the Global Clock input signal using the fastest process, lowest temperature, and highest voltage. These measurements include PLL CLKOUT0 jitter.
2. IFF = Input Flip-Flop or Latch
3. Use IBIS to determine any duty-cycle distortion incurred using various standards.

Table 65: Global Clock Setup and Hold With PLL in Source-Synchronous Mode

Symbol	Description	Device	Speed Grade			Units
			-3	-2	-1L	
<b>Input Setup and Hold Time Relative to Global Clock Input Signal for LVC MOS25 Standard.<sup>(1)</sup></b>						
T <sub>PSPLL0</sub> / T <sub>PHPLL0</sub>	No Delay Global Clock and IFF <sup>(2)</sup> with PLL in Source-Synchronous Mode	XC6SLX4				ns
		XC6SLX9				ns
		XC6SLX16				ns
		XC6SLX25				ns
		XC6SLX25T			N/A	ns
		XC6SLX45				ns
		XC6SLX45T			N/A	ns
		XC6SLX75				ns
		XC6SLX75T			N/A	ns
		XC6SLX100				ns
		XC6SLX100T			N/A	ns
		XC6SLX150				ns
		XC6SLX150T			N/A	ns

**Notes:**

1. Setup and Hold times are measured over worst case conditions (process, voltage, temperature). Setup time is measured relative to the Global Clock input signal using the slowest process, highest temperature, and lowest voltage. Hold time is measured relative to the Global Clock input signal using the fastest process, lowest temperature, and highest voltage. These measurements include PLL CLKOUT0 jitter.
2. IFF = Input Flip-Flop or Latch
3. Use IBIS to determine any duty-cycle distortion incurred using various standards.

Table 66: Global Clock Setup and Hold With DCM and PLL in System-Synchronous Mode

Symbol	Description	Device	Speed Grade			Units
			-3	-2	-1L	
<b>Input Setup and Hold Time Relative to Global Clock Input Signal for LVC MOS25 Standard.<sup>(1)</sup></b>						
T <sub>PSDCMPLL</sub> / T <sub>PHDCMPLL</sub>	No Delay Global Clock and IFF <sup>(2)</sup> with DCM and PLL in System-Synchronous Mode	XC6SLX4				ns
		XC6SLX9				ns
		XC6SLX16				ns
		XC6SLX25				ns
		XC6SLX25T			N/A	ns
		XC6SLX45				ns
		XC6SLX45T			N/A	ns
		XC6SLX75				ns
		XC6SLX75T			N/A	ns
		XC6SLX100				ns
		XC6SLX100T			N/A	ns
		XC6SLX150				ns
		XC6SLX150T			N/A	ns

**Notes:**

1. Setup and Hold times are measured over worst case conditions (process, voltage, temperature). Setup time is measured relative to the Global Clock input signal using the slowest process, highest temperature, and lowest voltage. Hold time is measured relative to the Global Clock input signal using the fastest process, lowest temperature, and highest voltage. These measurements include CMT jitter; DCM CLK0 driving PLL, PLL CLKOUT0 driving BUFG.
2. IFF = Input Flip-Flop or Latch
3. Use IBIS to determine any duty-cycle distortion incurred using various standards.

Table 67: Global Clock Setup and Hold With DCM and PLL in Source-Synchronous Mode

Symbol	Description	Device	Speed Grade			Units
			-3	-2	-1L	
Example Data Input Set-Up and Hold Times Relative to a Forwarded Clock Input Pin, <sup>(1)</sup> Using DCM, PLL, and Global Clock Buffer. For situations where clock and data inputs conform to different standards, adjust the setup and hold values accordingly using the values shown in <a href="#">IOB Switching Characteristics</a> , page 15.						
$T_{PSDCMPLL\_0}$ $T_{PHDCMPLL\_0}$	No Delay Global Clock and IFF <sup>(2)</sup> with DCM and PLL in Source-Synchronous Mode	XC6SLX4				ns
		XC6SLX9				ns
		XC6SLX16				ns
		XC6SLX25				ns
		XC6SLX25T			N/A	ns
		XC6SLX45				ns
		XC6SLX45T			N/A	ns
		XC6SLX75				ns
		XC6SLX75T			N/A	ns
		XC6SLX100				ns
		XC6SLX100T			N/A	ns
		XC6SLX150				ns
		XC6SLX150T			N/A	ns

**Notes:**

1. Setup and Hold times are measured over worst case conditions (process, voltage, temperature). Setup time is measured relative to the Global Clock input signal using the slowest process, highest temperature, and lowest voltage. Hold time is measured relative to the Global Clock input signal using the fastest process, lowest temperature, and highest voltage. The timing values were measured using the fine-phase adjustment feature of the DCM. These measurements include CMT jitter; DCM CLK0 driving PLL, PLL CLKOUT0 driving BUFG. Package skew is not included in these measurements.
2. IFF = Input Flip-Flop

## Source-Synchronous Switching Characteristics

The parameters in this section provide the necessary values for calculating timing budgets for Spartan-6 FPGA source-synchronous transmitter and receiver data-valid windows.

Table 68: Duty Cycle Distortion and Clock-Tree Skew

Symbol	Description	Device	Speed Grade			Units
			-3	-2	-1L	
T <sub>DCD_CLK</sub>	Global Clock Tree Duty Cycle Distortion <sup>(1)</sup>	All				ns
T <sub>CKSKEW</sub>	Global Clock Tree Skew <sup>(2)</sup>	XC6SLX4				ns
		XC6SLX9				ns
		XC6SLX16				ns
		XC6SLX25				ns
		XC6SLX25T			N/A	ns
		XC6SLX45				ns
		XC6SLX45T			N/A	ns
		XC6SLX75				ns
		XC6SLX75T			N/A	ns
		XC6SLX100				ns
		XC6SLX100T			N/A	ns
		XC6SLX150				ns
		XC6SLX150T			N/A	ns
T <sub>DCD_BUFIO</sub>	I/O clock tree duty cycle distortion	All				ns
T <sub>BUFIO_SKEW</sub>	I/O clock tree skew across one clock region	All				ns

**Notes:**

1. These parameters represent the worst-case duty cycle distortion observable at the pins of the device using LVDS output buffers. For cases where other I/O standards are used, IBIS can be used to calculate any additional duty cycle distortion that might be caused by asymmetrical rise/fall times.
2. The T<sub>CKSKEW</sub> value represents the worst-case clock-tree skew observable between sequential I/O elements. Significantly less clock-tree skew exists for I/O registers that are close to each other and fed by the same or adjacent clock-tree branches. Use the Xilinx FPGA Editor and Timing Analyzer tools to evaluate clock skew specific to your application.

Table 69: Package Skew

Symbol	Description	Device	Package <sup>(3)</sup>	Value	Units
T <sub>PKGSKEW</sub>	Package Skew <sup>(1)</sup>	XC6SLX4	TQG144		ps
			CPG196		ps
			CSG225		ps
		XC6SLX9	TQG144		ps
			CPG196		ps
			CSG225		ps
			FT(G)256		ps
		XC6SLX16	CSG324		ps
			CPG196		ps
			CSG225		ps
			FT(G)256		ps
					CSG324

Table 69: Package Skew (Cont'd)

Symbol	Description	Device	Package <sup>(3)</sup>	Value	Units
T <sub>PKGSKEW</sub>	Package Skew <sup>(1)</sup>	XC6SLX25	FT(G)256		ps
			CSG324		ps
			FG(G)484		ps
		XC6SLX25T	CSG324		ps
			FG(G)484		ps
		XC6SLX45	CSG324		ps
			CSG484		ps
			FG(G)484		ps
			FG(G)676		ps
		XC6SLX45T	CSG324		ps
			CSG484		ps
			FG(G)484		ps
		XC6SLX75	CSG324		ps
			CSG484		ps
			FG(G)676		ps
		XC6SLX75T	CSG324		ps
			CSG484		ps
			FG(G)676		ps
		XC6SLX100	CSG484		ps
			FG(G)484		ps
			FG(G)676		ps
		XC6SLX100T	CSG484		ps
			FG(G)484		ps
			FG(G)676		ps
FG(G)900			ps		
XC6SLX150	CSG484		ps		
	FG(G)484		ps		
	FG(G)676		ps		
	FG(G)900		ps		
XC6SLX150T	CSG484		ps		
	FG(G)484		ps		
	FG(G)676		ps		
	FG(G)900		ps		

**Notes:**

1. These values represent the worst-case skew between any two SelectIO resources in the package: shortest flight time to longest flight time from Pad to Ball (7.0 ps per mm).
2. Package trace length information is available for these device/package combinations. This information can be used to deskew the package.
3. Some of these devices are available in both Pb and Pb-free (additional G) packages as standard ordering options.

Table 70: Sample Window

Symbol	Description	Device	Speed Grade			Units
			-3	-2	-1L	
T <sub>SAMP</sub>	Sampling Error at Receiver Pins <sup>(1)</sup>	All				ps
T <sub>SAMP_BUFIO</sub>	Sampling Error at Receiver Pins using BUFIO <sup>(2)</sup>	All				ps

**Notes:**

1. This parameter indicates the total sampling error of Spartan-6 FPGA DDR input registers, measured across voltage, temperature, and process. The characterization methodology uses the DCM to capture the DDR input registers' edges of operation. These measurements include:
  - CLK0 DCM jitter
  - DCM accuracy (phase offset)
  - DCM phase shift resolution
 These measurements do not include package or clock tree skew.
2. This parameter indicates the total sampling error of Spartan-6 FPGA DDR input registers, measured across voltage, temperature, and process. The characterization methodology uses the BUFIO clock network and IODELAY to capture the DDR input registers' edges of operation. These measurements do not include package or clock tree skew.

Table 71: Source-Synchronous Pin-to-Pin Setup/Hold and Clock-to-Out

Symbol	Description	Speed Grade			Units
		-3	-2	-1L	
<b>Data Input Setup and Hold Times Relative to a Forwarded Clock Input Pin Using BUFIO</b>					
T <sub>PSCS</sub> /T <sub>PHCS</sub>	Setup/Hold of I/O clock				ns
<b>Pin-to-Pin Clock-to-Out Using BUFIO</b>					
T <sub>ICKOFCS</sub>	Clock-to-Out of I/O clock				ns

## Revision History

The following table shows the revision history for this document.

Date	Version	Description of Revisions
06/24/09	1.0	Initial Xilinx release.
08/26/09	1.1	Added V <sub>FS</sub> to Table 1 and Table 2. Added R <sub>FUSE</sub> to Table 2. Added XC6SLX75 and XC6SLX75T to V <sub>BATT</sub> and I <sub>BATT</sub> in Table 1, Table 2, and Table 3. Corrected the quiescent supply current for the XC6SLX4 in Table 4. Updated Table 8. Removed DV <sub>PPIN</sub> from Figure 2. Removed F <sub>PCIECORE</sub> from Table 21 and added values to F <sub>PCIEUSER</sub> . Added more networking applications to Table 22. Updated values for T <sub>SUSPENDLOW_AWAKE</sub> , T <sub>SUSPEND_ENABLE</sub> , and T <sub>SCP_AWAKE</sub> in Table 40. Numerous changes to Table 41, page 33 including the addition of new values to various specifications, revising the T <sub>SMCKCSO</sub> description, and changing the units of T <sub>POR</sub> . Also, removed <i>Dynamic Reconfiguration Port (DRP) for DCM and PLL Before and After DCLK</i> section from Table 41 and updated all the notes. In Table 44, added to F <sub>INMAX</sub> , revised F <sub>OUTMAX</sub> , and removed PLL Maximum Output Frequency for BUFIO2. Revised values for DCM_DELAY_STEP in Table 46. Updated CLKIN_FREQ_FX values in Table 47.

## Notice of Disclaimer

THE XILINX HARDWARE FPGA AND CPLD DEVICES REFERRED TO HEREIN (“PRODUCTS”) ARE SUBJECT TO THE TERMS AND CONDITIONS OF THE XILINX LIMITED WARRANTY WHICH CAN BE VIEWED AT <http://www.xilinx.com/warranty.htm>. THIS LIMITED WARRANTY DOES NOT EXTEND TO ANY USE OF PRODUCTS IN AN APPLICATION OR ENVIRONMENT THAT IS NOT WITHIN THE SPECIFICATIONS STATED IN THE XILINX DATA SHEET. ALL SPECIFICATIONS ARE SUBJECT TO CHANGE WITHOUT NOTICE. PRODUCTS ARE NOT DESIGNED OR INTENDED TO BE FAIL-SAFE OR FOR USE IN ANY APPLICATION REQUIRING FAIL-SAFE PERFORMANCE, SUCH AS LIFE-SUPPORT OR SAFETY DEVICES OR SYSTEMS, OR ANY OTHER APPLICATION THAT INVOKES THE POTENTIAL RISKS OF DEATH, PERSONAL INJURY, OR PROPERTY OR ENVIRONMENTAL DAMAGE (“CRITICAL APPLICATIONS”). USE OF PRODUCTS IN CRITICAL APPLICATIONS IS AT THE SOLE RISK OF CUSTOMER, SUBJECT TO APPLICABLE LAWS AND REGULATIONS.